

FibuLock[®] Fibular Nail System

Surgical Technique

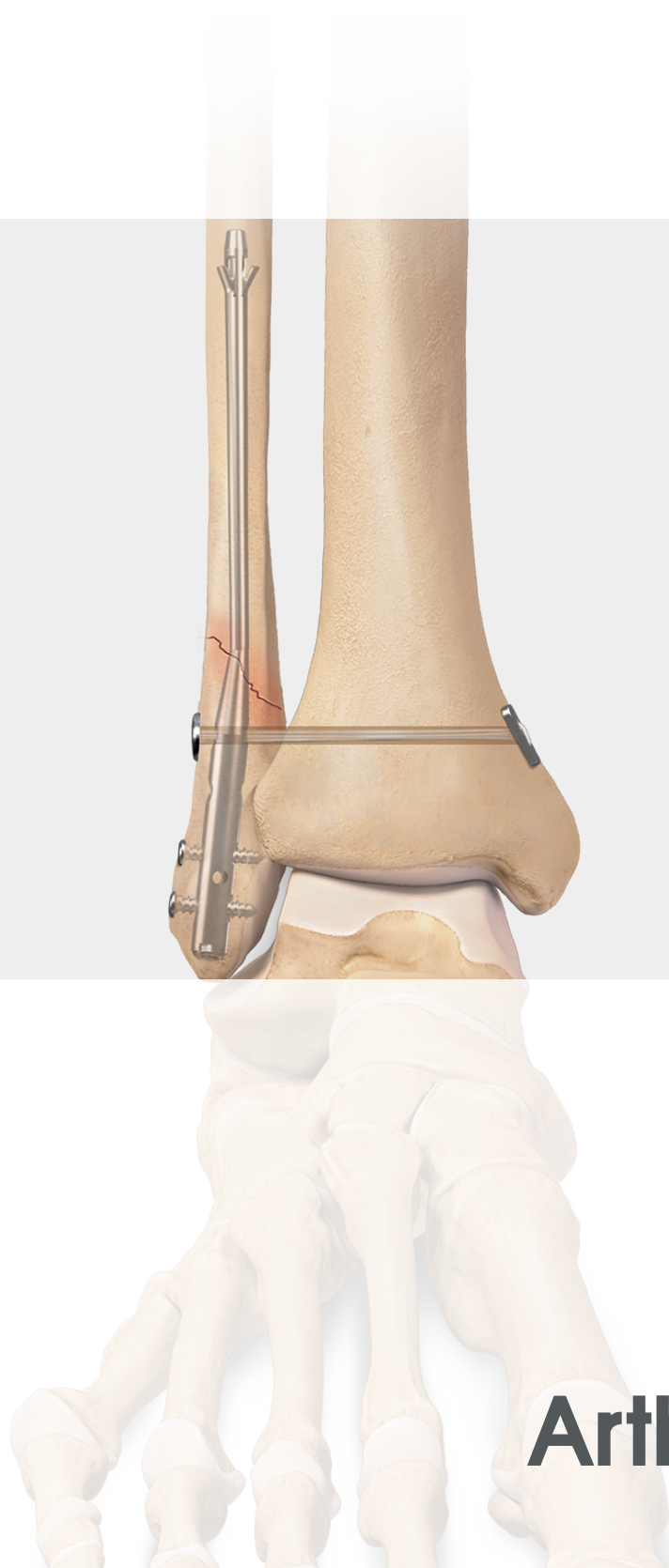

Arthrex[®] 

Introduction

Operative fixation of ankle fractures requires restoration of appropriate length and alignment of a stable ankle mortise. The FibuLock® fibular nail system was designed to fulfill those operative objectives while providing a soft-tissue–friendly, minimally invasive approach for fibula fractures.

The FibuLock fibular nail provides both proximal and distal fixation along with syndesmotic fixation with the Syndesmotic TightRope® XP implant. Multiplanar distal fixation options allow for treatment of almost any ankle fracture.

The nail insertion outrigger provides optional compression and ensures syndesmosis fixation is parallel to the mortise and reduced appropriately.

FibuLock® Fibular Nail

Talons:

- Provide proximal fixation
- May be easily deactivated for removal

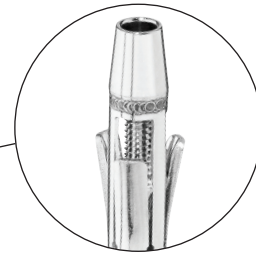

Specifications:

- 3.0 mm and 3.8 mm diameters
- 130 mm and 180 mm lengths
- 316L stainless steel

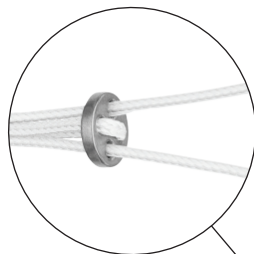

Syndesmosis Fixation:

- Accepts the Syndesmosis TightRope® XP implant or 3.5 mm syndesmotic screws

Multiplanar Screws:

- 2.7 mm cortical screws
- 2 lateral/medial screws
- 1 anterior/posterior screw

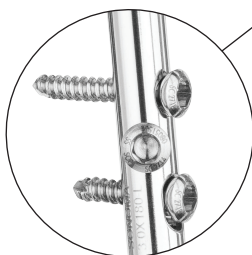

Compression Slot:

- Allows up to 2.5 mm of compression

Optional End Cap:

- Locks in compression
- Prevents bony ingrowth

FibuLock® Fibular Nail System—Preoperative Planning

Evaluating the proximal canal size preoperatively aids in selecting the appropriate sized nail diameter. Initially, it is important to determine if the isthmus, or canal, is large enough to accept a 3.2 mm reamer.

Basic AP and lateral radiographic landmarks (isthmus and fibular fossa) of the distal fibula will aid in entry point accuracy and ensure the guidewire is central in the canal.

- Isthmus
- Malleolar fossa
- Correct entry point—lateral to the edge of the malleolar fossa

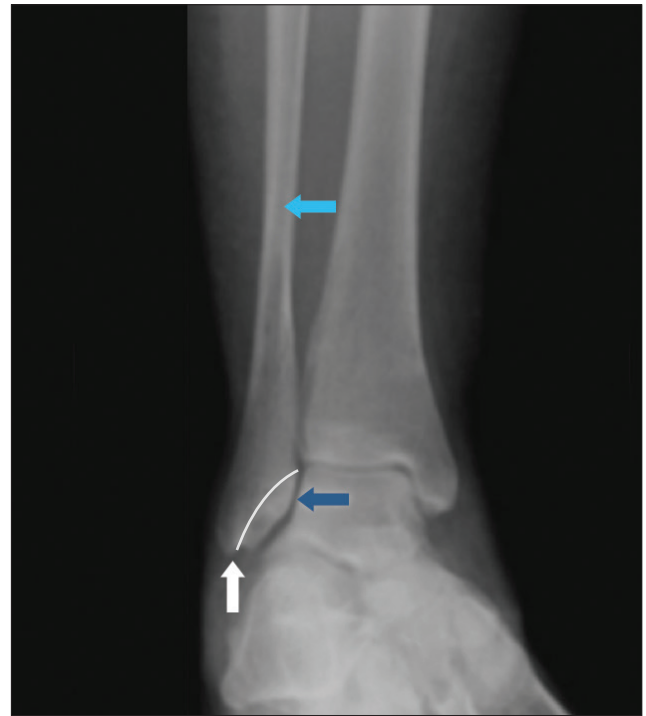

Patient Positioning

Suggested patient position is supine on a radiolucent table.

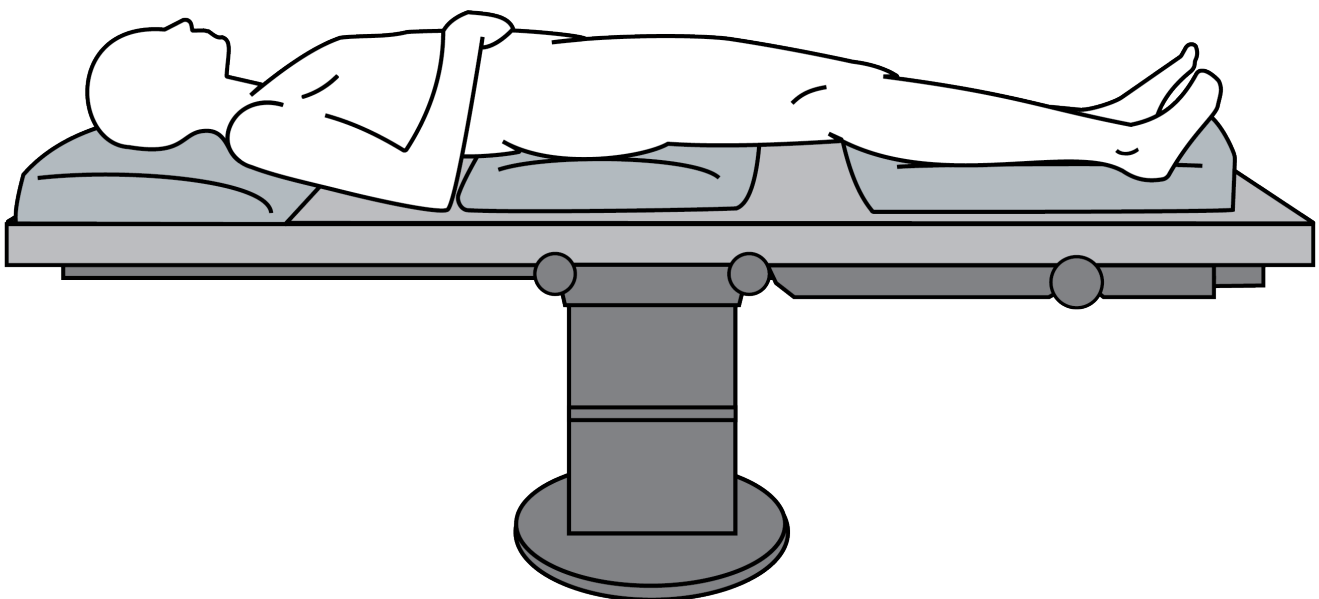

Entry Point

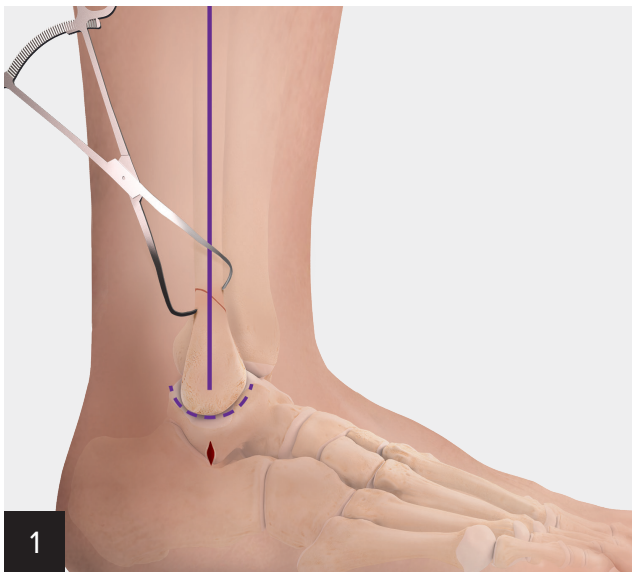

Make a small skin incision 1 cm distal to the tip of the fibula. When reducing the fracture, place clamp handles proximally to avoid outrigger interference. Many reductions are percutaneous, but older, healed fractures may require a limited open approach for anatomic reduction.

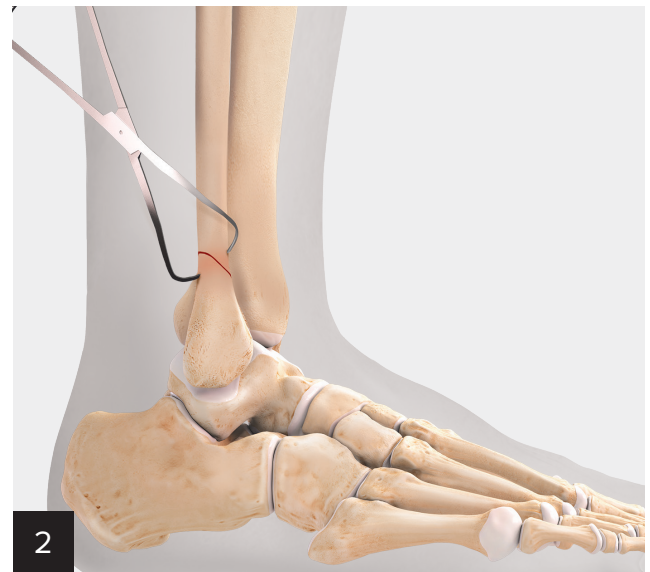

Entry Point and Initial Guidewire Trajectory:

Establish the entry point using the 1.6 mm guidewire and tissue protector. Advance the guidewire 15 mm to 20 mm into the distal fibula with the drill on oscillate. Supinating the foot will increase accessibility to the distal fibula.

Starting Point

AP: Lateral to the edge of the malleolar fossa

Lateral: In line with the center of the canal

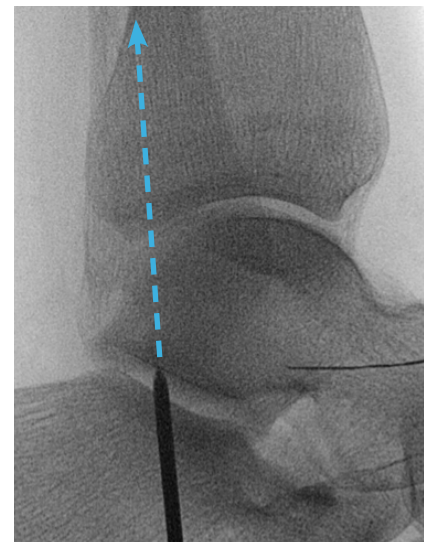
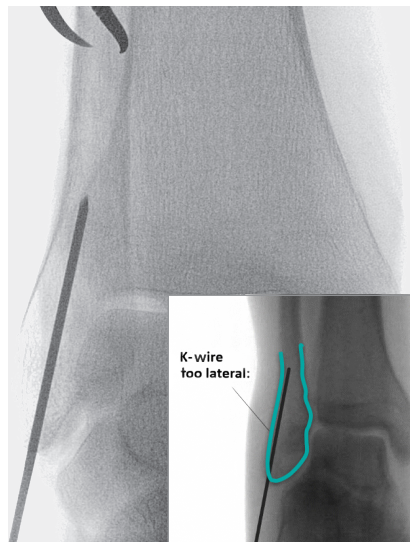
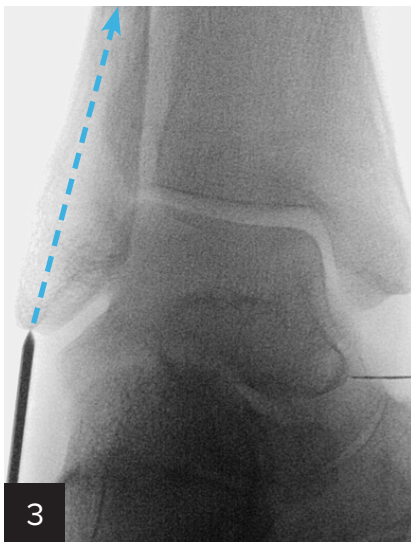

Take multiple AP and lateral fluoroscopy views to ensure the guidewire is angled towards the center of the canal.

Note: Avoid placing the guidewire too lateral as reaming will violate the lateral cortex of the fibula. Once a good entry point and trajectory are established, advance the guidewire further into the fibula.

Distal Reaming

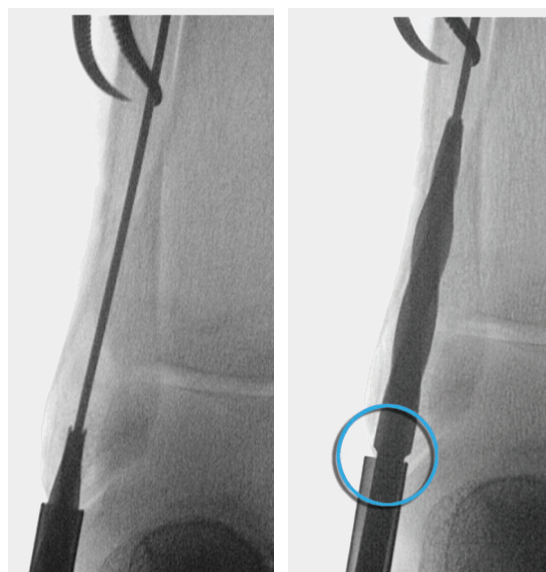
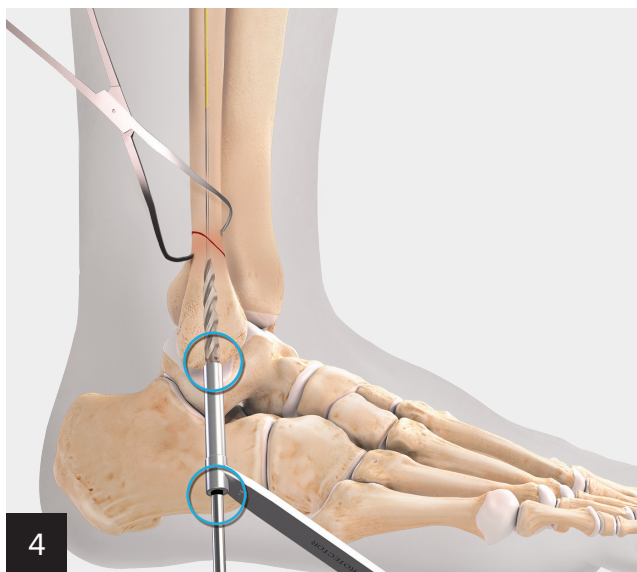

Drive the 6.2 mm tapered reamer over the guidewire and through the tissue protector until the reamer flutes are fully within the bone. However, if there is adequate room, burying the flutes at least 3 mm can be advantageous. The reamer shaft features a secondary depth indicator correlating to the back of the tissue protector.

Proximal Reaming

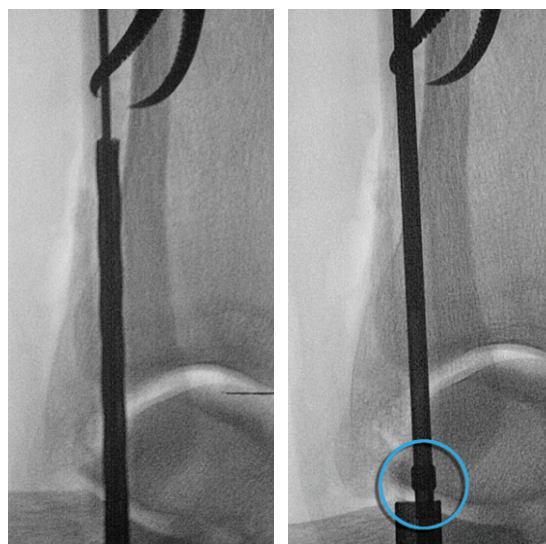
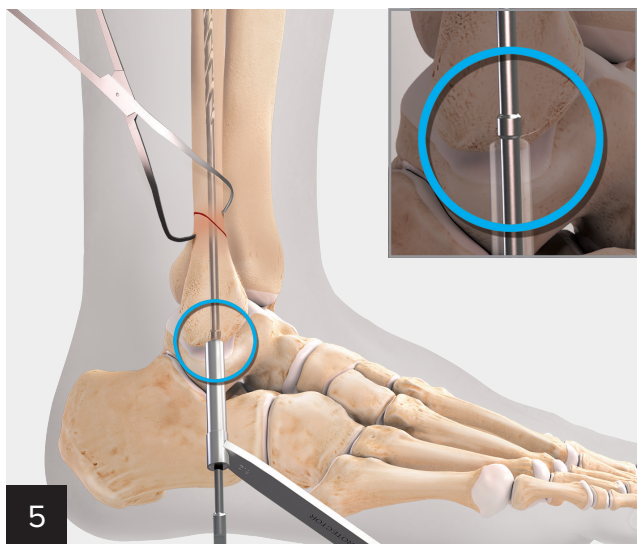

Drive the 3.2 mm reamer over the guidewire and through the tissue protector, until the depth indicator collar is well within the bone. If chatter is not evident, repeat with the 4.0 mm reamer. Reamer placement should be checked in two planes to avoid cortical disruption. Use the corresponding long reamers for 180 mm nails when indicated.

Ream on oscillate and recheck the reduction after this step. Attach the appropriate nail (diameter and length) to the outrigger.

Note: 3.2 mm reamer = 3.0 mm nail, 4.0 mm reamer = 3.8 mm nail.

Outrigger Nail Assembly

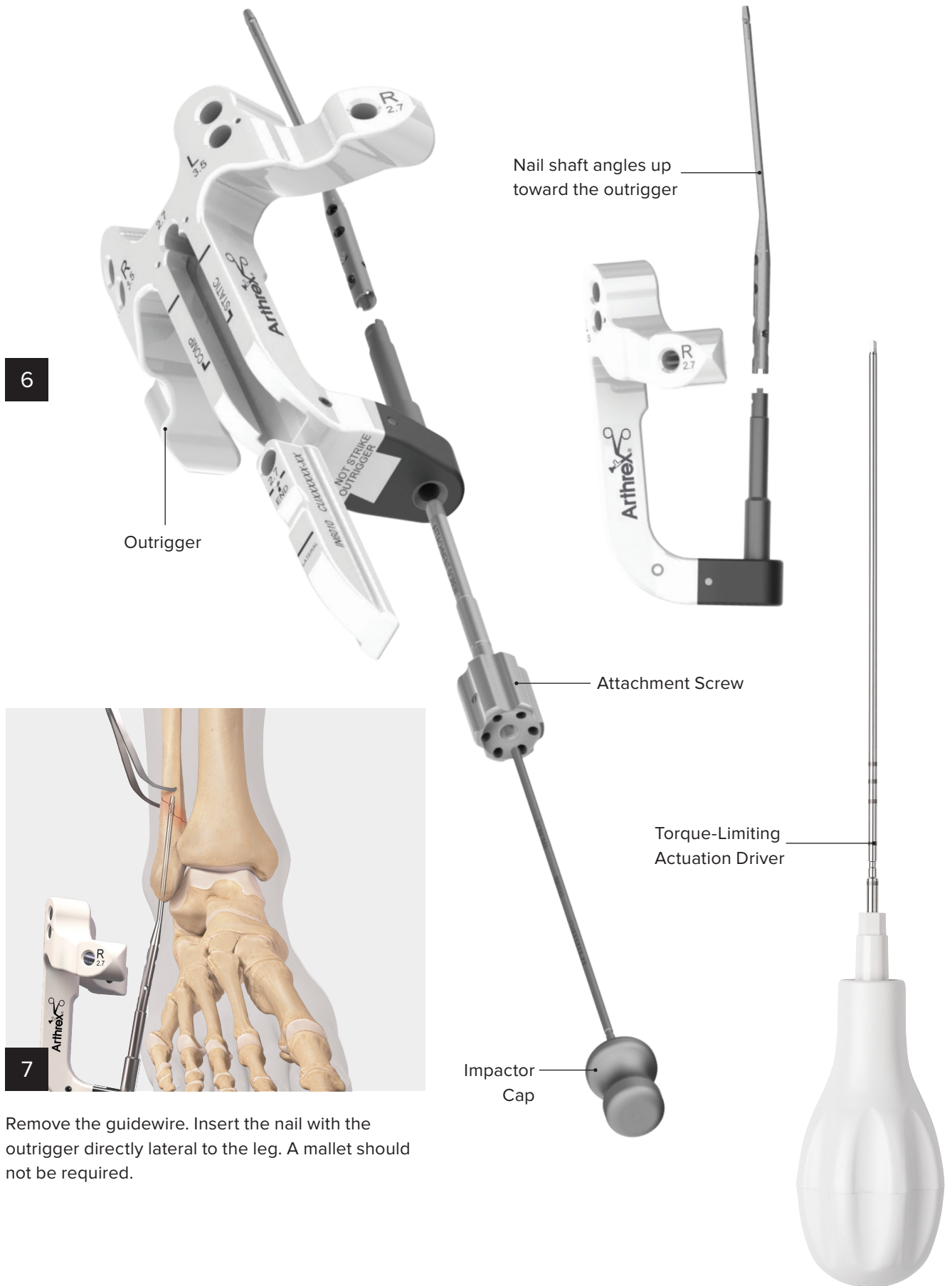

6

Outrigger

Nail shaft angles up toward the outrigger

Attachment Screw

Torque-Limiting Actuation Driver

Impactor Cap

7

Remove the guidewire. Insert the nail with the outrigger directly lateral to the leg. A mallet should not be required.

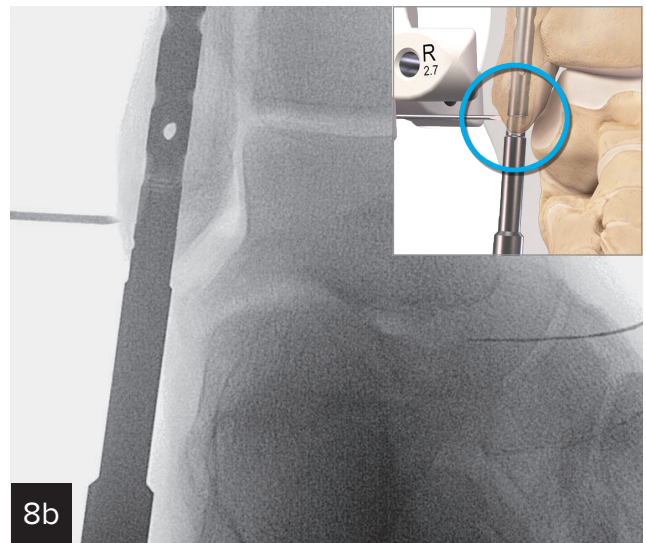
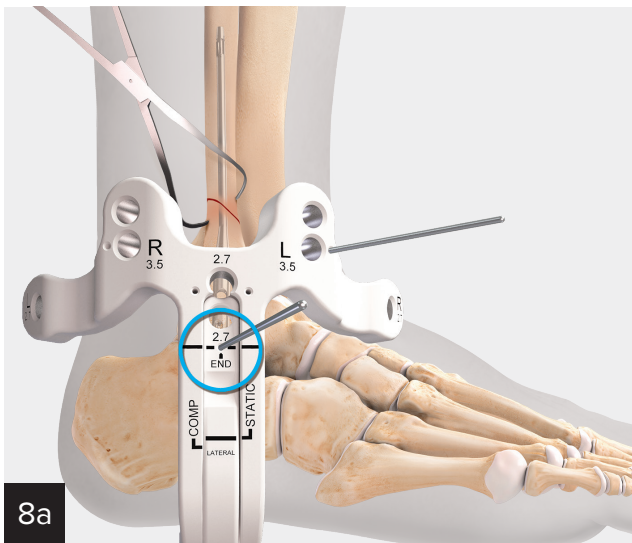

After inserting the nail and before activating the talons, confirm the position of the nail on fluoroscopy **(8b)**. Place a 1.6 mm K-wire in the outrigger “end hole” to confirm that the distal portion of the nail (blue circle) is flush or countersunk in the fibula.

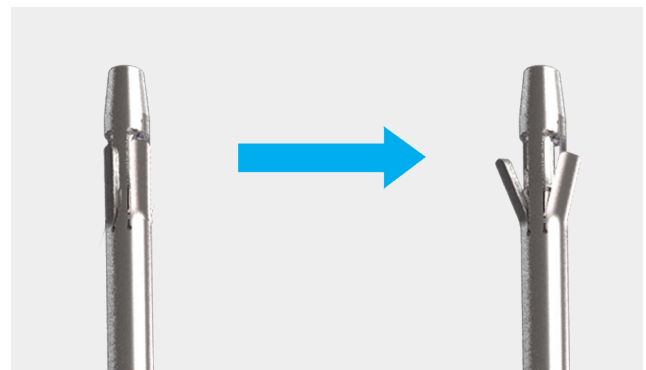
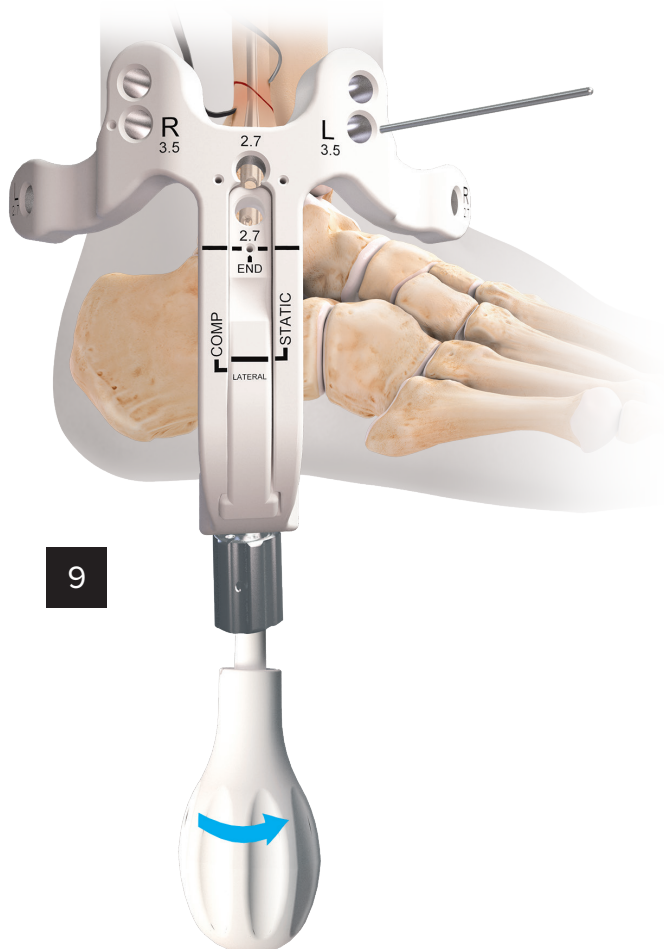

Actuate the Talons

Confirm the outrigger is positioned lateral prior to actuation. Remove the impactor cap. Insert the actuation driver. Hold the outrigger while actuating to prevent rotation. Turn the actuation driver until it “clicks” to deploy the talons. The talons may not deploy fully in a tight canal. Do not rotate the nail after talon actuation. K-wires can be placed through the outrigger to control rotation provisionally.

- 3 mm nail talons expand to 5 mm
- 3.8 mm nail talons expand to 6 mm

2.7 mm Distal Screw Fixation

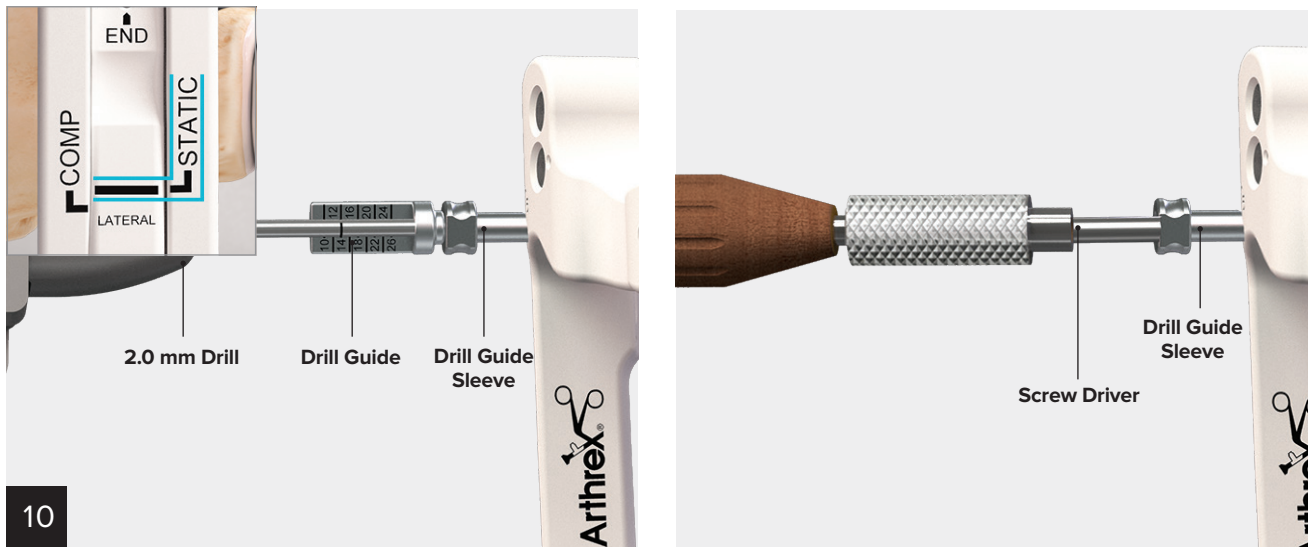

Ensure the outrigger slide is in the “static” position. Insert the drill guide sleeve and 2 mm drill guide into a 2.7 mm hole in the outrigger. The proximal lateral-to-medial hole is the most commonly used. Drill, measure, and insert the appropriate 2.7 mm screw through the drill guide sleeve. Repeat in the other lateral to medial hole and the anterior to posterior hole as needed.

Syndesmotic Fixation



Drill all four cortices approximately 1.5 cm from the ankle joint, in the transmalleolar plane through the jig, using the 3.7 mm drill bit.

TightRope® Implant	3.5 mm Screw
Drill Guide Sleeve	Drill Guide Sleeve
3.7 mm Syndesmotic Drill Guide (black)	2.5 mm Syndesmotic Drill Guide (gold)
3.7 mm Drill Bit	2.5 mm Drill Bit
TightRope XP Implant	3.5 mm Syndesmotic Screw

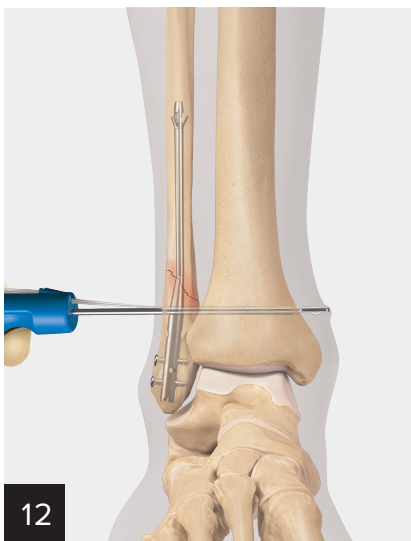

12 Check under fluoroscopy to ensure the medial button exits the medial tibia cortex. Advance the Syndesmosis TightRope® XP implant system through the fibula and tibia bone tunnel. Position the black button on the blue handle inserter cephalad or caudad.

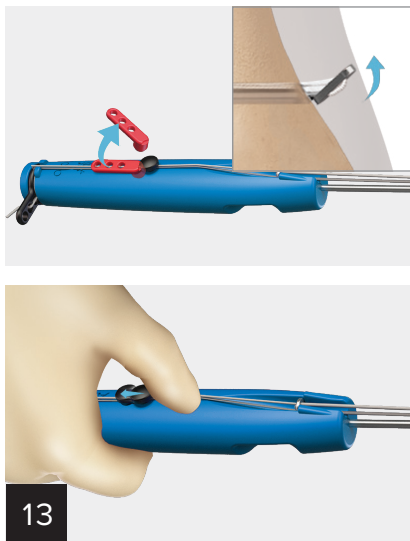

13 Remove the red safety tab. Deploy the medial button on the Syndesmosis TightRope XP handle by engaging the black button away from the TightRope construct.

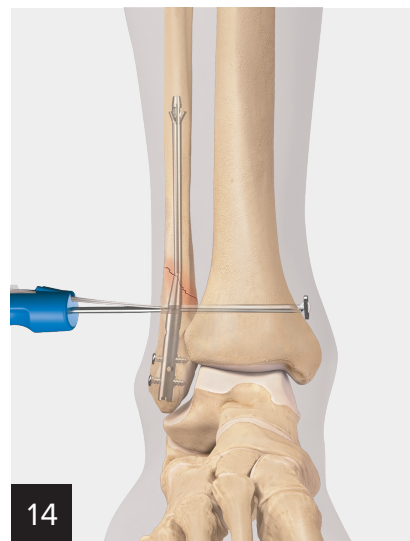

14 **Important:** After deploying the medial button, push the Syndesmosis TightRope XP implant medially. Visualize a T shape on fluoroscopy. Once the position of the medial button has been confirmed, remove the TightRope sutures and lateral button from the blue handle, then tension appropriately.

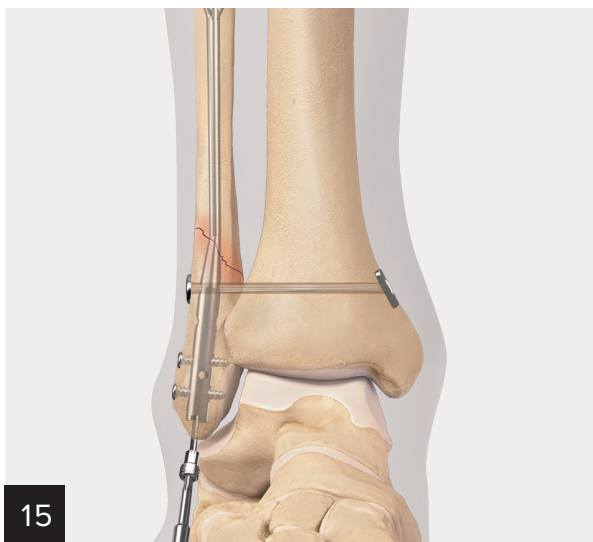

15 **Insert the End Cap**
Insert a 1.35 mm K-wire into the nail end. Screw the end cap over the K-wire into the nail using the cannulated T15 driver.

Final fixation.

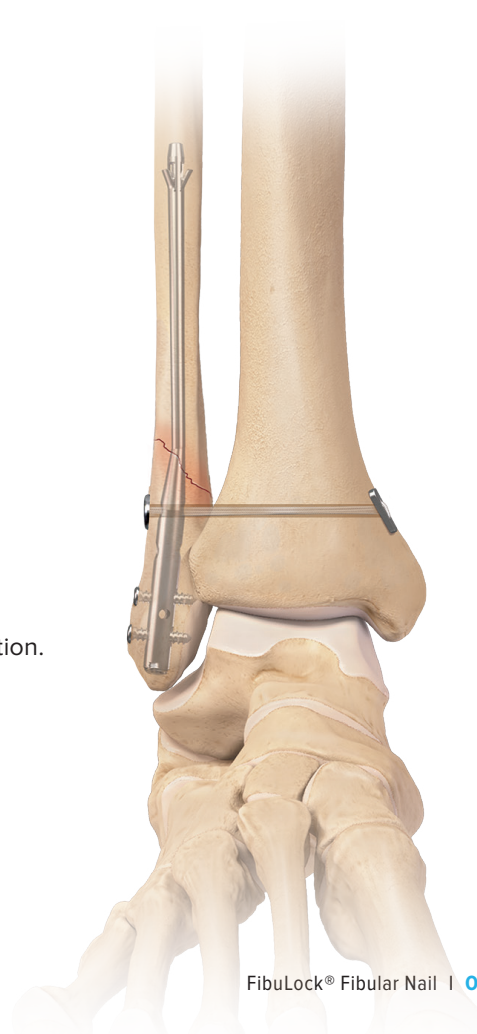

Optional Steps—Entry Point

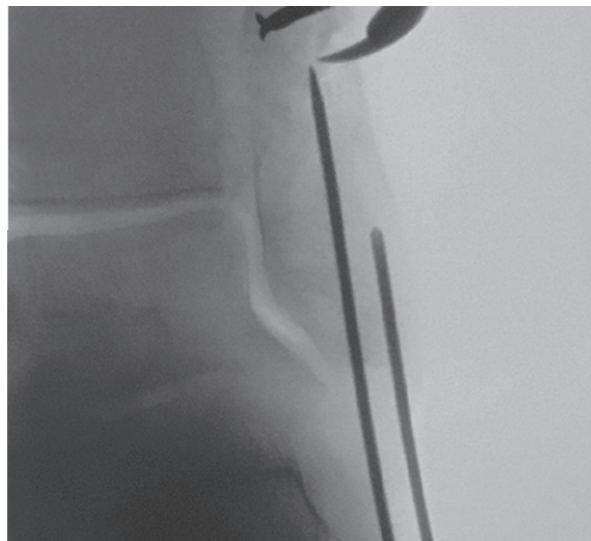
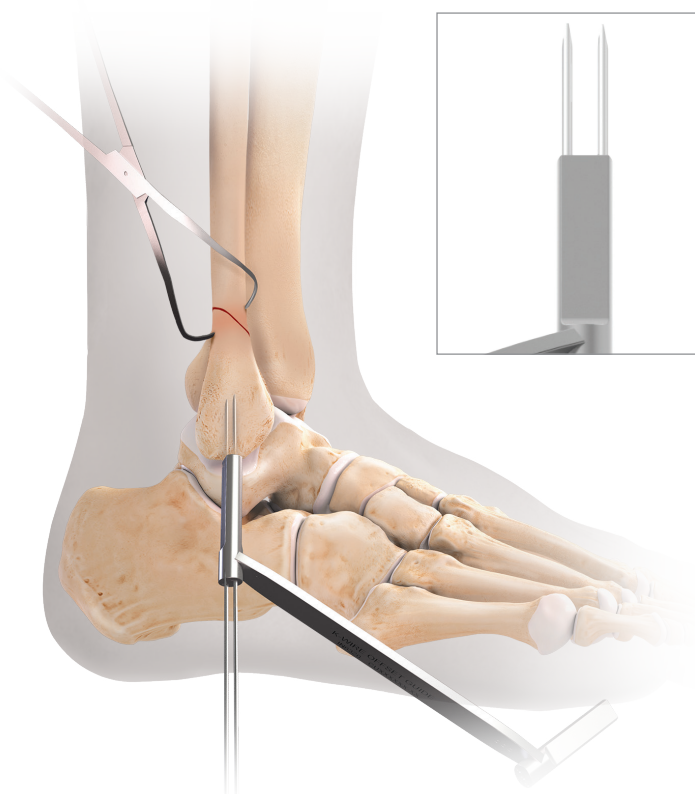

If the guidewire is malpositioned, the guidewire offset guide can be used to redrill a new guidewire 2.5 mm or 5 mm from the initial guidewire.

Optional Steps—Fracture Finger Technique

If there is difficulty getting the guidewire past the fracture or the guidewire keeps getting caught on the medial cortex, the fracture finger technique can be used to insert the guidewire proximally in the fibular canal.

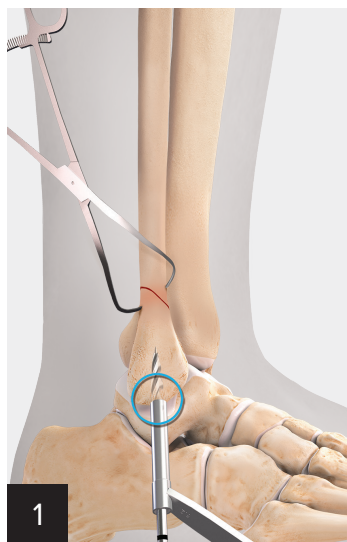

1 Widen the hole in the cortex by driving the 6.2 mm tapered reamer to half the length of the fluted section. Remove the K-wire and reamer.



2 Insert the fracture finger past the fracture if possible. Direct the tip of the finger toward the center of the canal. Insert the spade-tip guidewire on oscillate (gold tip first) through the hole in the finger handle and into the canal.

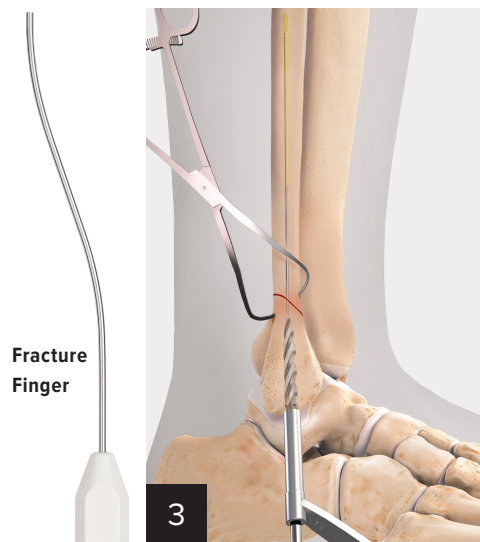

Fracture Finger

3 Remove the fracture finger, leaving the guidewire in place, and ream the distal and proximal portion with the 6.2 mm/3.2 mm reamers.

Optional Steps—Nail Insertion With Guide

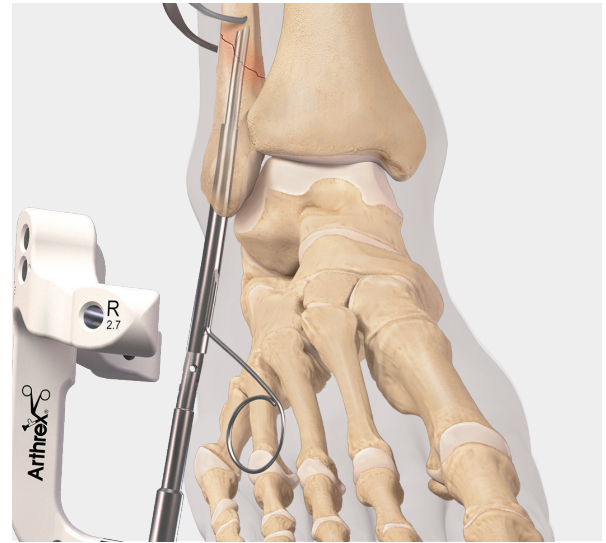

Retain the guidewire. Place the insertion guide over the guidewire and into the distal fragment. Remove the inner cannula (with the round, white handle) and guidewire, retaining the V-channel in the canal.

Optional Steps—Compression Technique

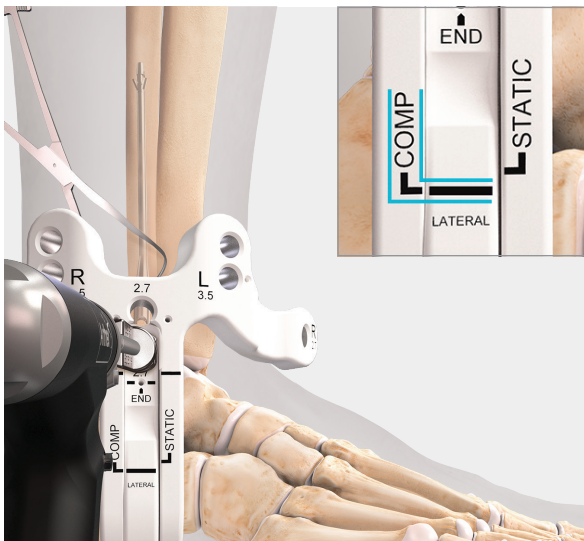

Compression Driver



When compression is desired, it must be performed prior to inserting any distal screws. Move the outrigger slide to the “COMP” position. Insert the drill guide sleeve and 2 mm drill guide into the most distal 2.7 mm hole in the outrigger. Drill, measure, and insert the corresponding 2.7 mm screw.

Thread the compression driver into the back of the outrigger attachment screw and turn clockwise to compress the fracture. Keep the compression driver in place to maintain compression until another distal screw is implanted or it is time to insert the end cap, which must be used while in compression mode. Maximum achievable compression is 2.5 mm.

FibuLock® Fibular Nail Sizes

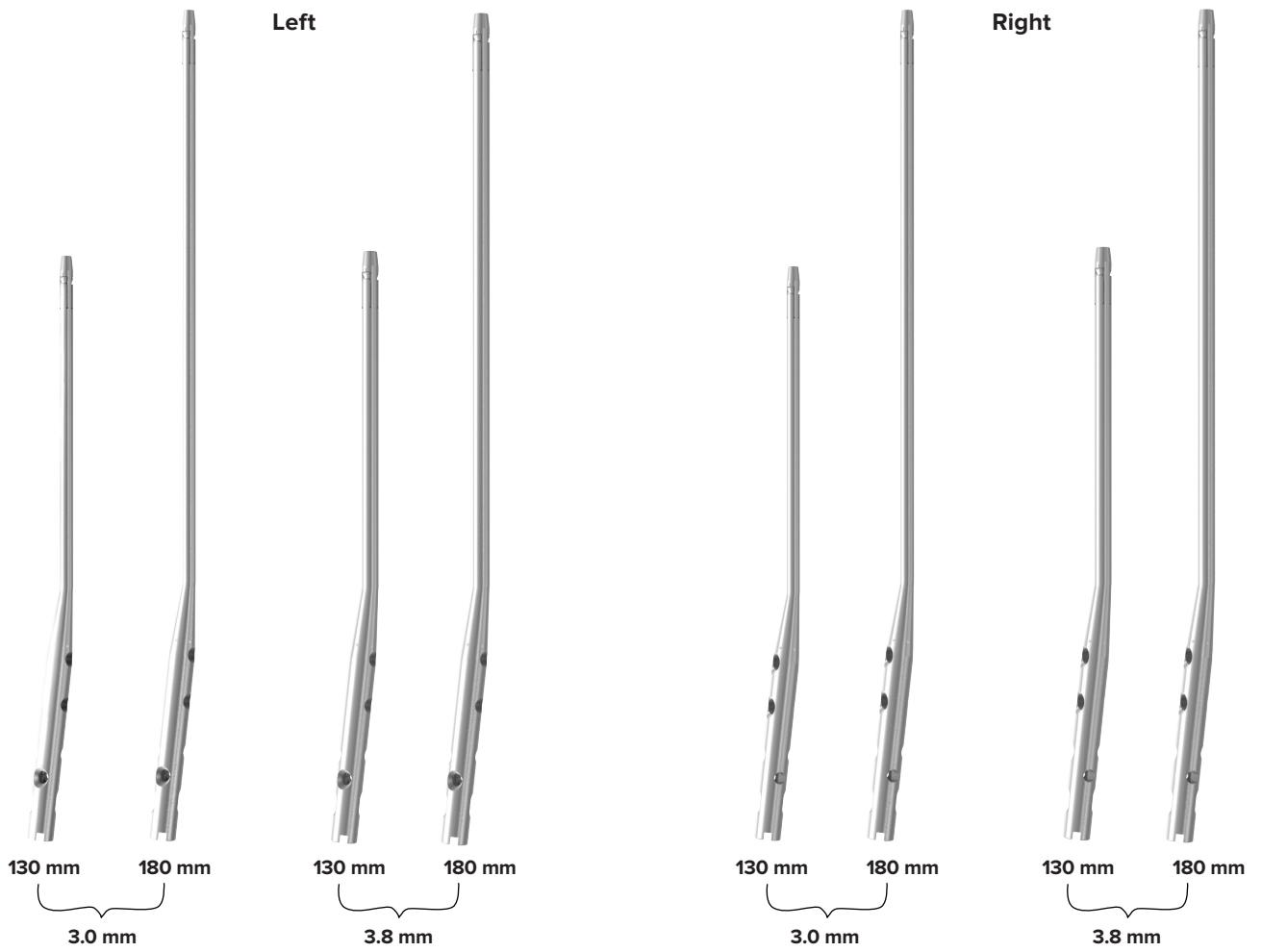

2.7 mm Screw
12 mm-34 mm

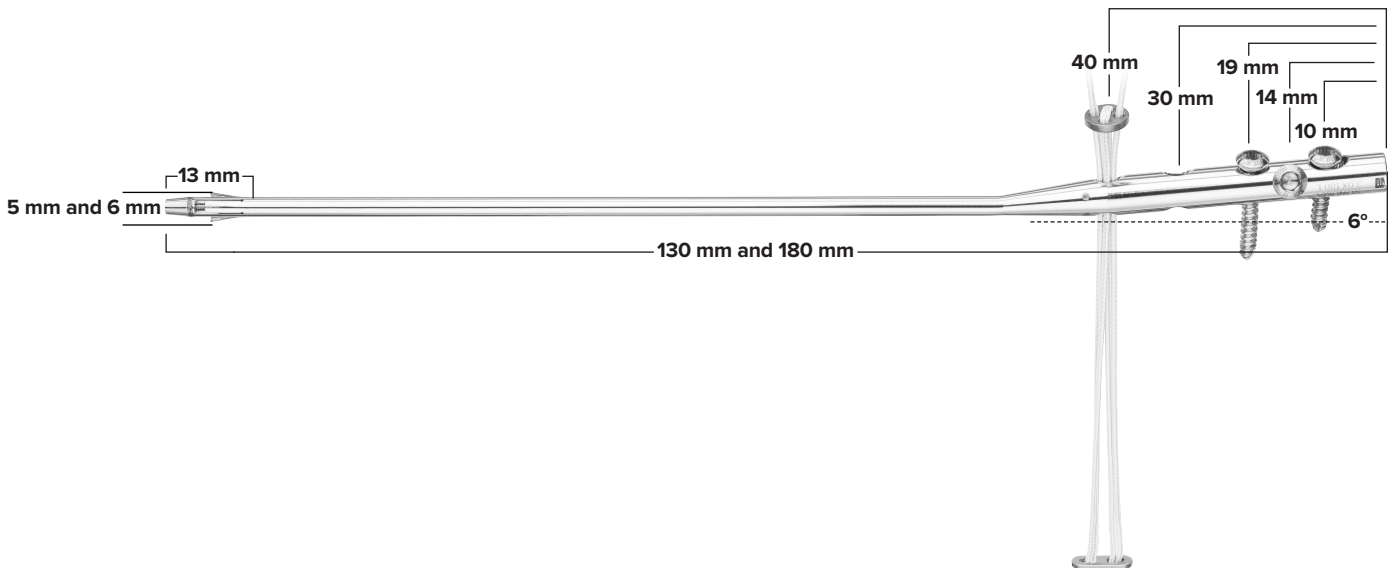

FibuLock® Fibular Nail Drop-in System

Designed to fit into our existing ankle fracture trays, the FibuLock fibular nail system is a convenient, all-in-one solution for fibula fractures.

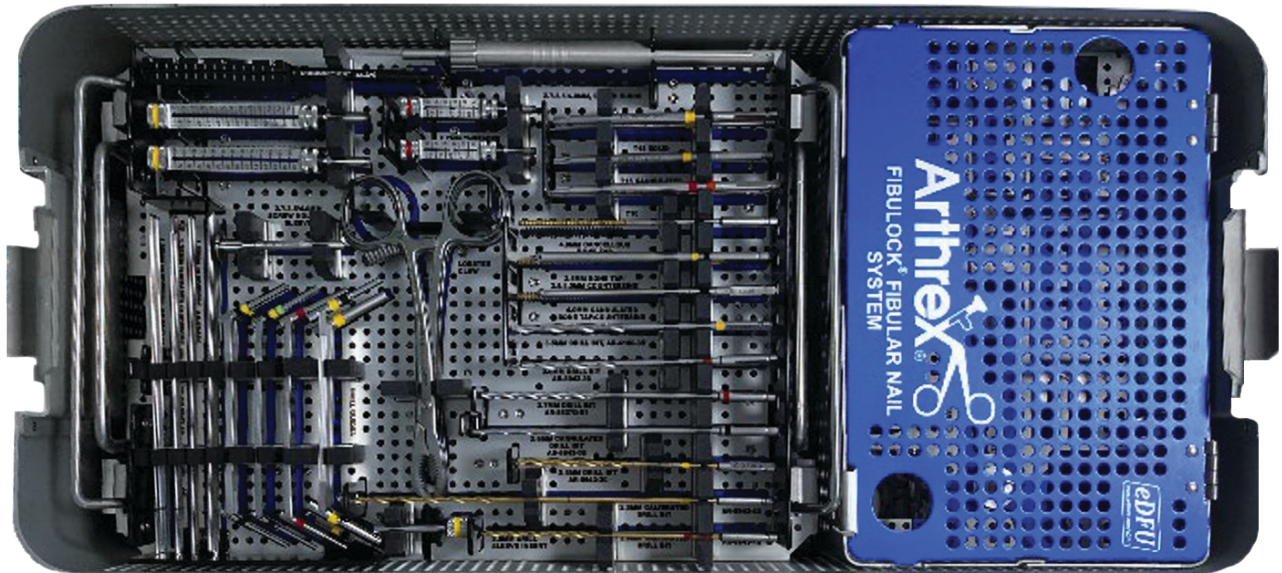

Ordering Information

FibuLock® Fibular Nail System (AR-8973S)

Product Description	Item Number
Targeting Guide	AR-8973-01
Outrigger Compression Screw Guide	AR-8973-02
Hub Attachment Screw	AR-8973-03
Impactor Cap	AR-8973-04
Compression Driver	AR-8973-05
Tissue Protector, double-sided	AR-8973-06
Drill Guide Sleeve	AR-8973-07
Drill Guide, 2 mm	AR-8973-08
Drill, syndesmosis, 2.5 mm	AR-8973-25
Drill Guide, syndesmosis, 2.5 mm	AR-8973-09
Drill, syndesmosis TightRope® implant, 3.7 mm	AR-8973-37
Drill Guide, syndesmosis TightRope Implant, 3.7 mm	AR-8973-10
FibuLock Hexalobe Driver, T10	AR-8973-11
FibuLock Hexalobe Driver, T15, cannulated	AR-8973-12
Fracture Finger/Guidewire Insert	AR-8973-13
Implant Insertion Guide	AR-8973-14
Parallel Drill Guide, 1.6 mm	AR-8973-15
FibuLock Nail Tray Insert	AR-8943C-FN
FibuLock Nail Caddy-Screw Insert	AR-8943C-FNS

Implants

Product Description	Item Number
Fibula Nail, left, 3.0 × 130 mm	AR-8973L-30-130
Fibula Nail, right, 3.0 × 130 mm	AR-8973R-30-130
Fibula Nail, left, 3.0 × 180 mm	AR-8973L-30-180
Fibula Nail, right, 3.0 × 180 mm	AR-8973R-30-180
Fibula Nail, left, 3.8 × 130 mm	AR-8973L-38-130
Fibula Nail, right, 3.8 × 130 mm	AR-8973R-38-130
Fibula Nail, left, 3.8 × 180 mm	AR-8973L-38-180
Fibula Nail, right, 3.8 × 180 mm	AR-8973R-38-180

Low Profile Screws, Stainless Steel

Product Description	Item Number
Nonlocking, cortical, 2.7 mm × 12 mm–24 mm (2 mm increments)	AR-8827-12 – 24
Nonlocking, cortical, 3.5 mm × 14 mm–60 mm (2 mm increments), 65 mm, 70 mm, 75 mm, 80 mm	AR-8835-14 – 80

Disposables

Product Description	Item Number
Washer, 7 mm	AR-8870W

FibuLock® Removal Kit, sterile

Product Description	Item Number
Removal Screw Strike Plate Deactivator	AR-8973RK

FibuLock Implant System, sterile

Product Description	Item Number
Actuation Driver Proximal Reamer, cannulated, 3.2 mm Distal Reamer, cannulated, 6.2 mm Drill, 2 mm Guidewire, spade tip, 1.1 mm × 22 in Guidewire, coated, 1.6 mm × 12 in, qty. 2 End Cap	AR-8973DS

Optional

Product Description	Item Number
Reamer, long, cannulated, sterile, 3.2 mm	AR-8973-32LS
Reamer, cannulated, sterile, 4.0 mm	AR-8973-40S
Reamer, long, cannulated, sterile, 4.0 mm	AR-8973-40LS
Syndesmosis TightRope® XP Implant System, stainless steel	AR-8925SS

Products may not be available in all markets because product availability is subject to the regulatory approvals and medical practices in individual markets. Please contact your Arthrex representative if you have questions about the availability of products in your area.



Guidewire, Spade
Tip, 1.1 mm



Actuation Driver

Drill Guide Sleeve

Drill Guide, 2 mm

Drill, 2 mm

T10 Hexalobe Driver
and Handle

Fracture Finger



This description of technique is provided as an educational tool and clinical aid to assist properly licensed medical professionals in the usage of specific Arthrex products. As part of this professional usage, the medical professional must use their professional judgment in making any final determinations in product usage and technique. In doing so, the medical professional should rely on their own training and experience, and should conduct a thorough review of pertinent medical literature and the product's directions for use. Postoperative management is patient-specific and dependent on the treating professional's assessment. Individual results will vary and not all patients will experience the same postoperative activity level and/or outcomes.

arthrex.com

© 2024-04 Arthrex, Inc. All rights reserved. LT1-00099-EN_E



Arthrex manufacturer,
authorized representative,
and importer information
(Arthrex eIFUs)



US patent information