

Arthroplasty

Next Generation in Repair and Reconstruction

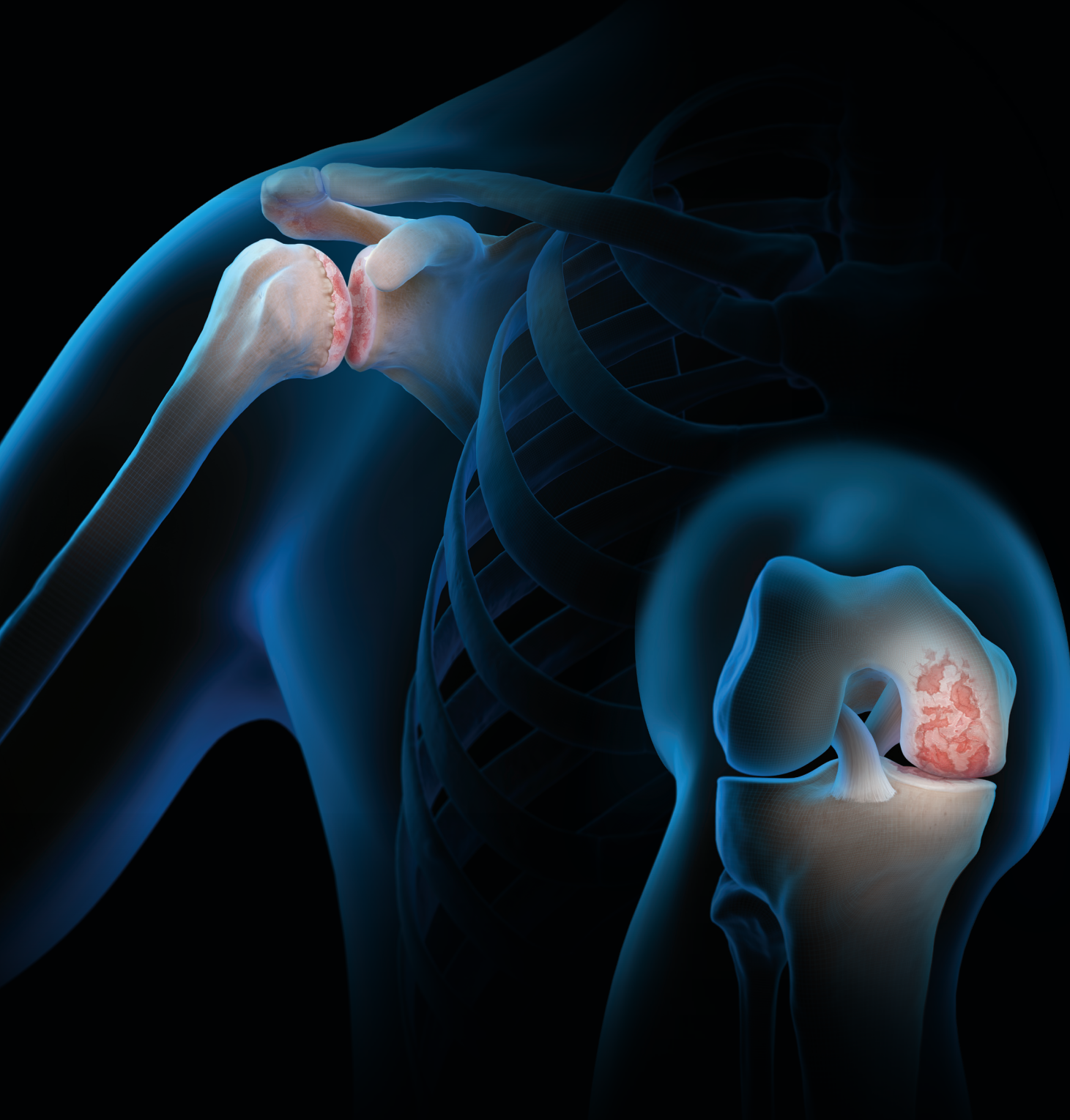

Helping Surgeons Treat Their Patients Better[®]

Since its inception, Arthrex has been committed to one mission: Helping Surgeons Treat Their Patients Better. We are strategically focused on constant product innovation through scientific research, surgeon collaboration, and medical education to make less invasive surgical procedures simple, safer and more reproducible. Each year, we develop more than 1,000 new innovative products and procedures to advance minimally invasive orthopedics worldwide.

Arthrex has always remained a privately held company, which allows for the rapid evaluation of new technologies and ideas and the freedom to develop products and techniques that truly make a difference. Our experienced team of dedicated professionals represents a shared passion and commitment to delivering uncompromising quality to the health care providers who use our products and the millions of patients whose lives we impact.

The medical significance of our contributions serves as our primary benchmark of success and will continue into the future as the legacy of Arthrex.

Table of Contents

Shoulder Arthroplasty	05
Knee Arthroplasty	67

Shoulder Arthroplasty

Solutions for Partial and Total Shoulder Replacement

Eclipse™ Total Shoulder System	06
Eclipse™ Shoulder Instrument Case	08
Eclipse™ SpeedScap™ Implant System	10
Univers™ II/Univers Apex OptiFit™/Univers Apex Total Shoulder Systems	11
Univers™ II Humeral Preparation Set	13
Univers™ Apex Humeral Preparation Set	14
Univers™ II/Apex Combined Humeral Preparation	15
Univers VaultLock® Glenoid System	19
Keeled Glenoid	20
Univers VaultLock® and Keel Glenoid Instrument Set	21
Univers VaultLock® Augmented Glenoid System	23
Universal Glenoid™ Convertible Baseplate	28
Universal Glenoid™ Instrument Set	29
Univers Revers™ Total Shoulder System	32
Univers Revers™ Apex Humeral Instrumentation Set	35
Univers Revers™ Humeral Broach Instrumentation Set	36
Univers Revers™ CA Head and Adapter Trials	40
Univers Revers™ Modular Glenoid System	42
Bone Graft Preparation for the Univers Revers™ Modular Glenoid System	49
Univers Revers™ Augmented Modular Glenoid System	52
Augmented Modular Glenoid System Instrument Set	54
Univers Revers™ Fracture Adapter	56
FxBridge™ Tuberosity Repair System	58
Shoulder Arthroplasty Retractor Set	59
Virtual Implant Positioning™ (VIP™) System	62
Glenoid Targeter Instrument Set	63
VIP™ Glenoid Reaming System Set	64



Stemless Anatomic Shoulder Prosthesis

- Individual anatomic reconstruction of the humeral head—the prosthesis is adjusted to the cortical rim of the humeral resection at the anatomical neck
- Humeral head can be positioned independently from humeral shaft axis—particularly important in post-traumatic arthritis cases
- Variable humeral head heights for anatomic reconstruction
- Preserved bone in the humeral shaft enables primary-like setting in the event of revision arthroplasty
- Potential for less invasive exposure
- More than a decade of long-term survivorship data¹
- Proprietary cage-screw fixation provides dynamic compression at the bone-prosthesis interface and reduces medial calcar osteolysis²
- Streamlined 3-step implantation

Humeral Heads	37 mm-55 mm (2 mm increments) Humeral heads offered in cobalt-chrome and titanium (special order)
Heights	Anatomic and Extended (+2 mm) Note: Only one head height is available for 37 mm
Cage Screw	Small: 30 mm Medium: 35 mm Large: 40 mm X-Large: 45 mm
Trunnion	37 mm-55 mm (sized with humeral head)

Eclipse™ Total Shoulder System (Cont.)

Implants

Product Description	Item Number
Trunnions	
Eclipse Trunnion, slotted, 37 mm, TPS- and CaP-coated	AR-9301-37CPC
Eclipse Trunnion, slotted, 39 mm, TPS- and CaP-coated	AR-9301-39CPC
Eclipse Trunnion, slotted, 41 mm, TPS- and CaP-coated	AR-9301-41CPC
Eclipse Trunnion, slotted, 43 mm, TPS- and CaP-coated	AR-9301-43CPC
Eclipse Trunnion, slotted, 45 mm, TPS- and CaP-coated	AR-9301-45CPC
Eclipse Trunnion, slotted, 47 mm, TPS- and CaP-coated	AR-9301-47CPC
Eclipse Trunnion, slotted, 49 mm, TPS- and CaP-coated	AR-9301-49CPC
Eclipse Trunnion, slotted, 51 mm, TPS- and CaP-coated	AR-9301-51CPC
Eclipse Trunnion, slotted, 53 mm, TPS- and CaP-coated	AR-9301-53CPC
Eclipse Trunnion, slotted, 55 mm, TPS- and CaP-coated	AR-9301-55CPC
Cage Screws	
Eclipse Cage Screw, 30 mm, small	AR-9301-01
Eclipse Cage Screw, 35 mm, medium	AR-9301-02
Eclipse Cage Screw, 40 mm, large	AR-9301-03
Eclipse Cage Screw, 45 mm, x-large	AR-9301-04
CoCr Humeral Heads	
Eclipse Humeral Head, 37 mm/16 mm	AR-9337-16
Eclipse Humeral Head, 39 mm/16 mm	AR-9339-16
Eclipse Humeral Head, 39 mm/18 mm	AR-9339-18
Eclipse Humeral Head, 41 mm/18 mm	AR-9341-16
Eclipse Humeral Head, 41 mm/16 mm	AR-9341-18
Eclipse Humeral Head, 43 mm/16 mm	AR-9343-16
Eclipse Humeral Head, 43 mm/18 mm	AR-9343-18
Eclipse Humeral Head, 45 mm/17 mm	AR-9345-17
Eclipse Humeral Head, 45 mm/19 mm	AR-9345-19
Eclipse Humeral Head, 47 mm/18 mm	AR-9347-18
Eclipse Humeral Head, 47 mm/20 mm	AR-9347-20
Eclipse Humeral Head, 49 mm/18 mm	AR-9349-18
Eclipse Humeral Head, 49 mm/20 mm	AR-9349-20
Eclipse Humeral Head, 51 mm/19 mm	AR-9351-19
Eclipse Humeral Head, 51 mm/21 mm	AR-9351-21
Eclipse Humeral Head, 53 mm/20 mm	AR-9353-20
Eclipse Humeral Head, 53 mm/22 mm	AR-9353-22
Eclipse Humeral Head, 55 mm/21 mm	AR-9355-21
Eclipse Humeral Head, 55 mm/23 mm	AR-9355-23
Titanium Humeral Heads	
Eclipse Titanium Humeral Head, 37 mm/16 mm	AR-9337-16T
Eclipse Titanium Humeral Head, 39 mm/16 mm	AR-9339-16T
Eclipse Titanium Humeral Head, 41 mm/16 mm	AR-9341-16T
Eclipse Titanium Humeral Head, 43 mm/16 mm	AR-9343-16T
Eclipse Titanium Humeral Head, 45 mm/17 mm	AR-9345-17T
Eclipse Titanium Humeral Head, 47 mm/18 mm	AR-9347-18T
Eclipse Titanium Humeral Head, 49 mm/18 mm	AR-9349-18T
Eclipse Titanium Humeral Head, 51 mm/19 mm	AR-9351-19T
Eclipse Titanium Humeral Head, 53 mm/20 mm	AR-9353-20T
Eclipse Titanium Humeral Head, 55 mm/21 mm	AR-9355-21T

Disposables

Product Description	Item Number
Eclipse and Univers™ II Pin Set	AR-9207S
Eclipse Sterile Cage Screw Sizer	AR-9401-08S

Eclipse™ Shoulder Instrument Case

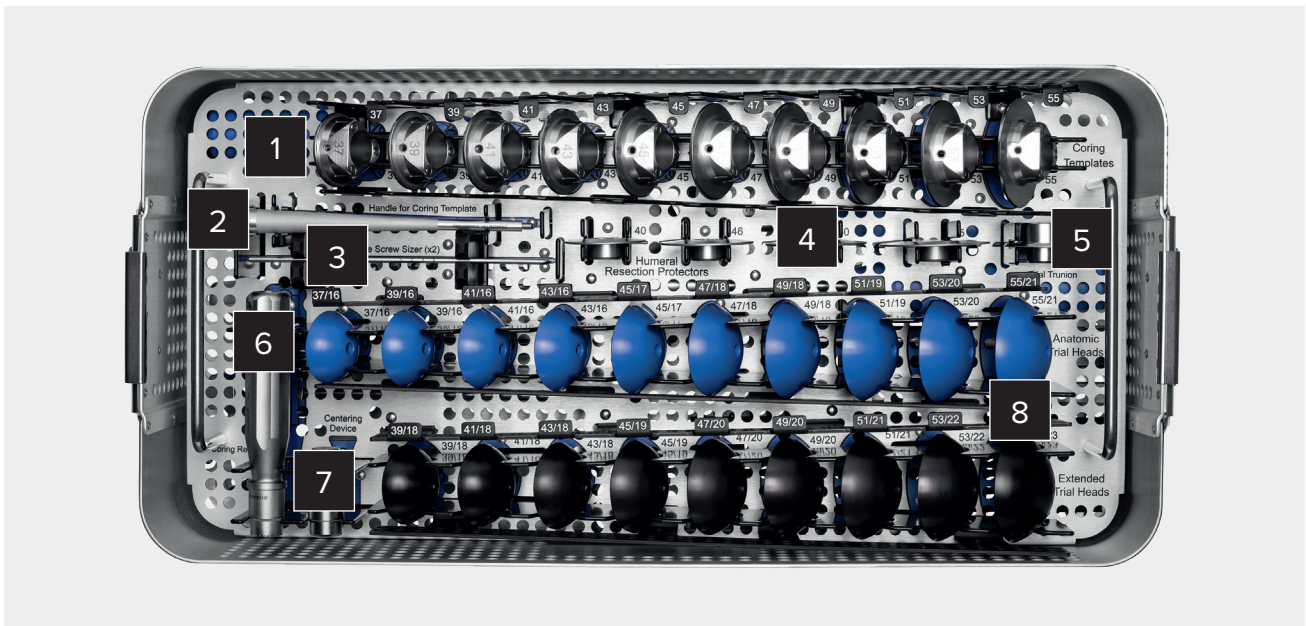

Eclipse Shoulder Instrument Case - Top Tray (AR-9400S)

Label	Product Description	Item Number	Label	Product Description	Item Number
1	Eclipse Coring Template, 37 mm	AR-9400-37	8	Eclipse Trial Head, 37 mm/16 mm	AR-9437-16
	Eclipse Coring Template, 39 mm	AR-9400-39		Eclipse Trial Head, 39 mm/16 mm	AR-9439-16
	Eclipse Coring Template, 41 mm	AR-9400-41		Eclipse Trial Head, 39 mm/18 mm	AR-9439-18
	Eclipse Coring Template, 43 mm	AR-9400-43		Eclipse Trial Head, 41 mm/16 mm	AR-9441-16
	Eclipse Coring Template, 45 mm	AR-9400-45		Eclipse Trial Head, 41 mm/18 mm	AR-9441-18
	Eclipse Coring Template, 47 mm	AR-9400-47		Eclipse Trial Head, 43 mm/16 mm	AR-9443-16
	Eclipse Coring Template, 49 mm	AR-9400-49		Eclipse Trial Head, 43 mm/18 mm	AR-9443-18
	Eclipse Coring Template, 51 mm	AR-9400-51		Eclipse Trial Head, 45 mm/17 mm	AR-9445-17
	Eclipse Coring Template, 55 mm	AR-9400-55		Eclipse Trial Head, 45 mm/19 mm	AR-9445-19
2	Univers™ and Eclipse Handle for Drilling Template	AR-9203-10		Eclipse Trial Head, 47 mm/18 mm	AR-9447-18
3	Eclipse Cage Screw Sizer	AR-9401-08		Eclipse Trial Head, 47 mm/20 mm	AR-9447-20
4	Eclipse Resection Protector, 40 mm, small	AR-9401-40		Eclipse Trial Head, 49 mm/18 mm	AR-9449-18
	Eclipse Resection Protector, 46 mm, medium	AR-9401-46		Eclipse Trial Head, 49 mm/20 mm	AR-9449-20
	Eclipse Resection Protector, 50 mm, large	AR-9401-50		Eclipse Trial Head, 51 mm/19 mm	AR-9451-19
	Eclipse Resection Protector, 55 mm, extra large	AR-9401-55		Eclipse Trial Head, 51 mm/21 mm	AR-9451-21
5	Eclipse Trial Trunnion	AR-9401-18		Eclipse Trial Head, 53 mm/20 mm	AR-9453-20
6	Eclipse Coring Reamer	AR-9401-02		Eclipse Trial Head, 53 mm/22 mm	AR-9453-22
7	Eclipse Centering Device	AR-9401-09		Eclipse Trial Head, 55 mm/21 mm	AR-9455-21
				Eclipse Trial Head, 55 mm/23 mm	AR-9455-23

Eclipse™ Shoulder Instrument Case (Cont.)

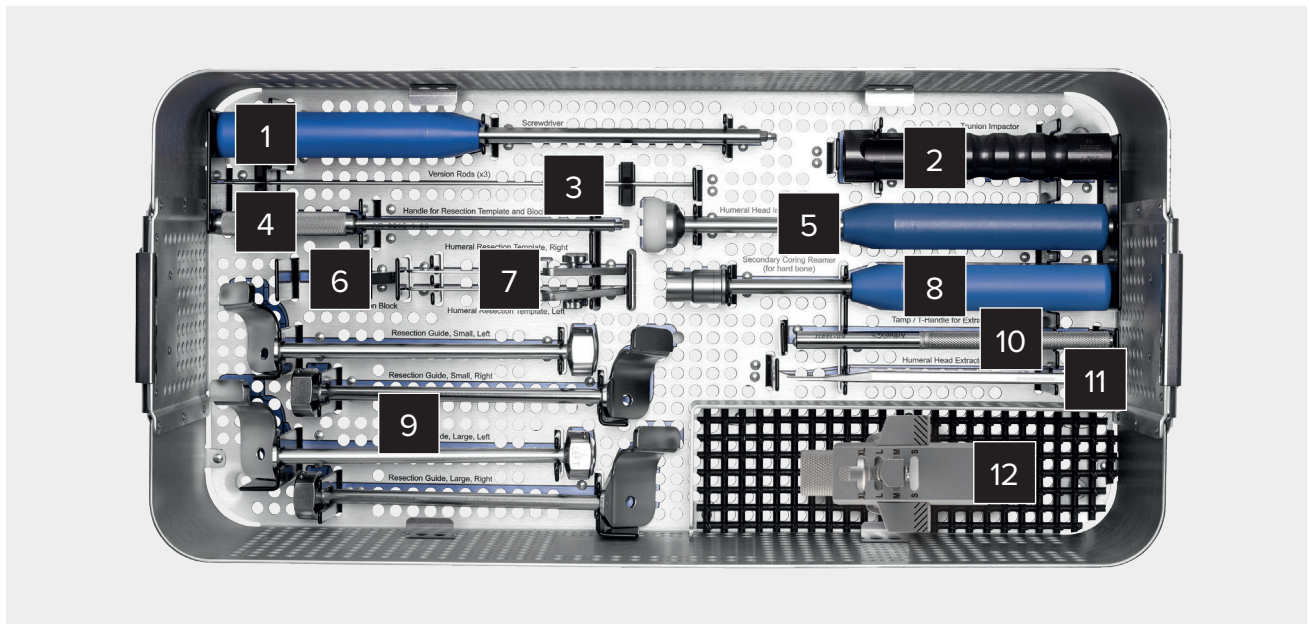

Eclipse Shoulder Instrument Case - Bottom Tray (AR-9400S)

Label	Product Description	Item Number
1	Eclipse Screwdriver	AR-9401-03
2	Eclipse Trunion Impactor	AR-9401-05
3	Eclipse and Univers™ Orientation Pin for Resection Guide	AR-9202
4	Handle for Resection Templates	AR-9215-1-02
5	Univers and Eclipse Handle for Head Impactor	AR-9203-13
6	Univers II and Eclipse Humeral Resection Block	AR-9205
7	Humeral Resection Template, left Humeral Resection Template, right	AR-9200-01L AR-9200-01R
8	Eclipse Coring Reamer, secondary	AR-9401-02L
9	Eclipse and Univers II Resection Guide, small, left Eclipse and Univers II Resection Guide, small, right Eclipse and Univers II Resection Guide, large, left Eclipse and Univers II Resection Guide, large, right	AR-9401-10 AR-9401-11 AR-9401-12 AR-9401-13
10	Bone Graft Tamp	AR-13317
11	Eclipse Humeral Head Extractor	AR-9401-17
12	Eclipse Targeting Adapter	AR-9402

Eclipse™ SpeedScap™ Implant System (AR-9400SBK)



- Contains all components needed to perform a knotless double-row subscapularis repair during stemless anatomic total shoulder arthroplasty
- FiberTak® DR and 3.9 mm SwiveLock® anchors, along with their appropriate drills, are designed for open shoulder surgery by incorporating a shorter driving and shaft length compared to those designed for arthroscopic shoulder surgery
- SutureTape link and free needle are included for easy passage of repair sutures through the subscapularis
- Two 1.3 mm SutureTapes are included for tensioning sutures during subscapularis release (peel) and rotator interval closure at the end of the operation

Product Description	Item Number
Eclipse SpeedScap Implant System	AR-9400-SBK
Eclipse Targeting Adapter	AR-9402

Univers™ II/Univers Apex OptiFit™/Univers Apex Total Shoulder Systems

Anatomic Shoulder Prosthesis: Individually Adaptable to Anatomical Variations of the Proximal Humerus

- Variable inclination (125°-140°) and version ($\pm 10^\circ$) for anatomic reconstruction
- Multiple head diameters and heights
- Eccentric humeral head options (3.5 mm offset)
- Cuff arthropathy heads available
- Humeral heads offered in cobalt-chrome and titanium
- OptiFit stem offers Titanium Plasma Spray (TPS) coating and a midsize length for ingrowth and additional stability



Inclination

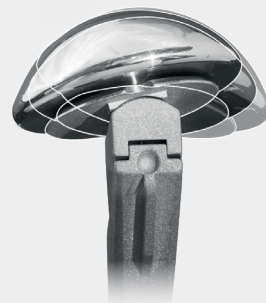

Version

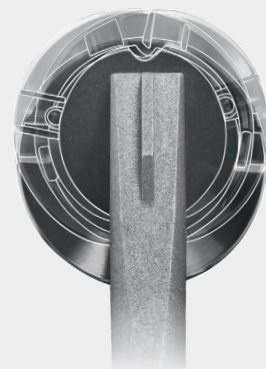

Offset

Univers™ II/Univers Apex OptiFit™/Univers Apex Total Shoulder Systems (Cont.)

Implants

Product Description	Item Number
Univers II/Apex Trunnion Replacement Kit	AR-9100TK
Stems	
Univers II Humeral Stem, 5 mm/105 mm	AR-9100-05P
Univers II Humeral Stem, 6 mm/115 mm	AR-9100-06P
Univers II Humeral Stem, 7 mm/140 mm	AR-9100-07P
Univers II Humeral Stem, 8 mm/143 mm	AR-9100-08P
Univers II Humeral Stem, 9 mm/146 mm	AR-9100-09P
Univers II Humeral Stem, 10 mm/148 mm	AR-9100-10P
Univers II Humeral Stem, 11 mm/151 mm	AR-9100-11P
Univers II Humeral Stem, 12 mm/151 mm	AR-9100-12P
Univers II Humeral Stem, 13 mm/151 mm	AR-9100-13P
Univers II Humeral Stem, 14 mm/151 mm	AR-9100-14P
Univers II Humeral Stem, 15 mm/151 mm	AR-9100-15P
Univers Apex OptiFit Humeral Stem, 5 mm/85 mm	AR-9100-05M
Univers Apex OptiFit Humeral Stem, 6 mm/85 mm	AR-9100-06M
Univers Apex OptiFit Humeral Stem, 7 mm/85 mm	AR-9100-07M
Univers Apex OptiFit Humeral Stem, 8 mm/85 mm	AR-9100-08M
Univers Apex OptiFit Humeral Stem, 9 mm/85 mm	AR-9100-09M
Univers Apex OptiFit Humeral Stem, 10 mm/85 mm	AR-9100-10M
Univers Apex OptiFit Humeral Stem, 11 mm/85 mm	AR-9100-11M
Univers Apex OptiFit Humeral Stem, 12 mm/85 mm	AR-9100-12M
Univers Apex OptiFit Humeral Stem, 13 mm/85 mm	AR-9100-13M
Univers Apex Humeral Stem, 5 mm/60 mm, 132.5° fixed	AR-9100-05S
Univers Apex Humeral Stem, 6 mm/60 mm	AR-9100-06S
Univers Apex Humeral Stem, 7 mm/60 mm	AR-9100-07S
Univers Apex Humeral Stem, 8 mm/60 mm	AR-9100-08S
Univers Apex Humeral Stem, 9 mm/60 mm	AR-9100-09S
Univers Apex Humeral Stem, 10 mm/60 mm	AR-9100-10S
Univers Apex Humeral Stem, 11 mm/60 mm	AR-9100-11S
Univers Apex Humeral Stem, 12 mm/60 mm	AR-9100-12S
Univers Apex Humeral Stem, 13 mm/65 mm	AR-9100-13S
Univers Apex Humeral Stem, 14 mm/65 mm	AR-9100-14S
Univers Apex Humeral Stem, 15 mm/65 mm	AR-9100-15S
CoCr Humeral Heads	
Univers II Humeral Head, 40 mm/17 mm	AR-9140-17P
Univers II Humeral Head, 42 mm/17 mm	AR-9142-17P
Univers II Humeral Head, 44 mm/17 mm	AR-9144-17P
Univers II Humeral Head, 44 mm/19 mm	AR-9144-19P
Univers II Humeral Head, 46 mm/18 mm	AR-9146-18P
Univers II Humeral Head, 46 mm/20 mm	AR-9146-20P
Univers II Humeral Head, 48 mm/19 mm	AR-9148-19P
Univers II Humeral Head, 48 mm/21 mm	AR-9148-21P
Univers II Humeral Head, 50 mm/19 mm	AR-9150-19P
Univers II Humeral Head, 50 mm/21 mm	AR-9150-21P
Univers II Humeral Head, 52 mm/20 mm	AR-9152-20P
Univers II Humeral Head, 52 mm/22 mm	AR-9152-22P
Univers II Humeral Head, 54 mm/21 mm	AR-9154-21P
Univers II Humeral Head, 54 mm/23 mm	AR-9154-23P
Univers II Humeral Head, 56 mm/22 mm	AR-9156-22P
Univers II Humeral Head, 56 mm/24 mm	AR-9156-24P

Product Description	Item Number
Titanium Humeral Heads	
Univers II Titanium Humeral Head, 40 mm/17 mm	AR-9140-17T
Univers II Titanium Humeral Head, 42 mm/17 mm	AR-9142-17T
Univers II Titanium Humeral Head, 44 mm/17 mm	AR-9144-17T
Univers II Titanium Humeral Head, 46 mm/18 mm	AR-9146-18P
Univers II Titanium Humeral Head, 48 mm/19 mm	AR-9148-19T
Univers II Titanium Humeral Head, 50 mm/19 mm	AR-9150-19T
Univers II Titanium Humeral Head, 52 mm/20 mm	AR-9152-20T
Univers II Titanium Humeral Head, 54 mm/21 mm	AR-9154-21T
Univers II Titanium Humeral Head, 56 mm/22 mm	AR-9156-22T
Cuff Arthropathy Humeral Heads	
Univers CA Humeral Head, 42 mm/17 mm	AR-9142-17CA
Univers CA Humeral Head, 44 mm/17 mm	AR-9144-17CA
Univers CA Humeral Head, 44 mm/19 mm	AR-9144-19CA
Univers CA Humeral Head, 46 mm/18 mm	AR-9146-18CA
Univers CA Humeral Head, 46 mm/20 mm	AR-9146-20CA
Univers CA Humeral Head, 48 mm/19 mm	AR-9148-19CA
Univers CA Humeral Head, 48 mm/21 mm	AR-9148-21CA
Univers CA Humeral Head, 50 mm/19 mm	AR-9150-19CA
Univers CA Humeral Head, 50 mm/21 mm	AR-9150-21CA
Univers CA Humeral Head, 52 mm/20 mm	AR-9152-20CA
Univers CA Humeral Head, 52 mm/22 mm	AR-9152-22CA
Univers CA Humeral Head, 54 mm/21 mm	AR-9154-21CA
Univers CA Humeral Head, 54 mm/23 mm	AR-9154-23CA
Univers CA Humeral Head, 56 mm/22 mm	AR-9156-22CA
Univers CA Humeral Head, 56 mm/24 mm	AR-9156-24CA

Disposables

Product Description	Item Number
#2 FiberWire® Suture (blue), 97 cm, w/ tapered needle, 26.5 mm, ½ circle	AR-7200
#2 FiberWire Suture (blue), 97 cm, w/ reverse cutting needle, 36.6 mm, ½ circle	AR-7202
#5 FiberWire Suture (blue), 97 cm	AR-7210
#5 FiberWire Suture (blue), 97 cm, w/ conventional cutting needle, 48 mm, ½ circle	AR-7211
FiberWire Suture Kit	AR-7219
FiberTape® Tendon Compression Bridge Kit	AR-7297
Univers Apex Suture Kit	AR-7298
Eclipse™ and Univers II Pin Set	AR-9207S

Univers™ II Humeral Preparation Set

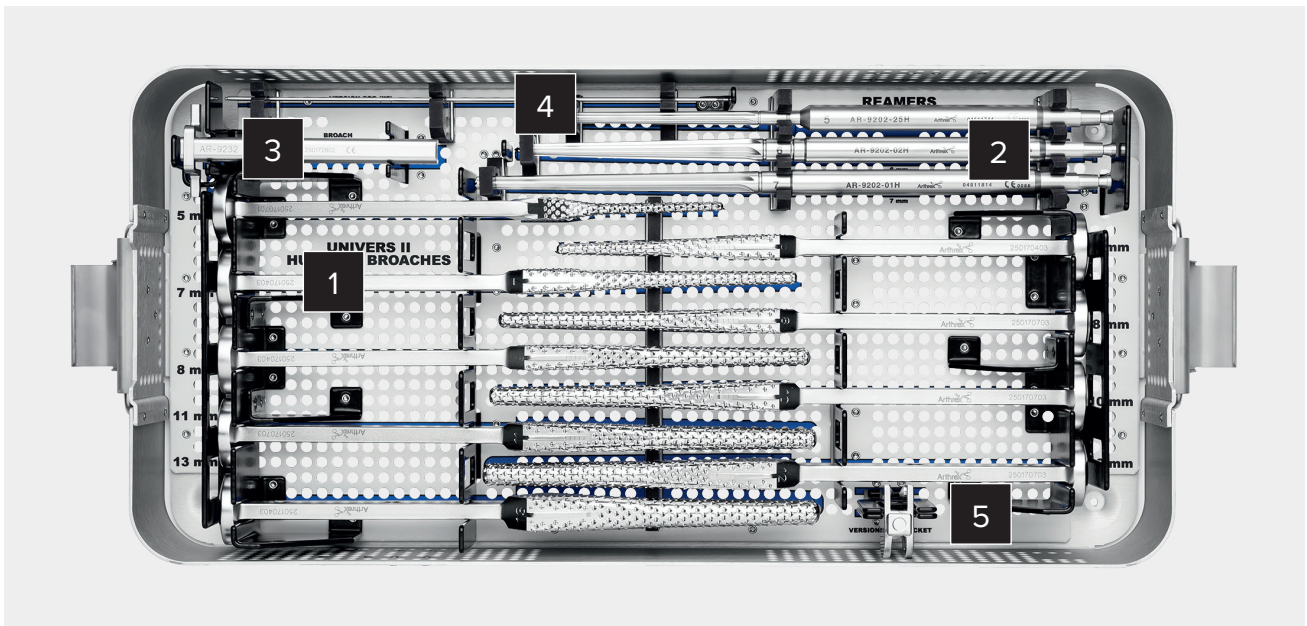

Univers II Humeral Preparation Set (AR-9226UBS)

Label	Product Description	Item Number
1	Univers II Broach, 5 mm	AR-9231-05
	Univers II Broach, 6 mm	AR-9231-06
	Univers II Broach, 7 mm	AR-9231-07
	Univers II Broach, 8 mm	AR-9231-08
	Univers II Broach, 9 mm	AR-9231-09
	Univers II Broach, 10 mm	AR-9231-10
	Univers II Broach, 11 mm	AR-9231-11
	Univers II Broach, 12 mm	AR-9231-12
	Univers II Broach, 13 mm	AR-9231-13
2	Univers II Reamer, 5 mm	AR-9202-25H
	Univers II Reamer, 6 mm	AR-9202-02H
	Univers II Reamer, 7 mm	AR-9202-01H
3	Univers II Guide for Humeral Broach	AR-9232
4	Univers/Eclipse™ Orientation Pin for Resection Guide	AR-9202
5	Univers II Version Rod Bracket for Broach	AR-9231-20

Univers™ Apex Humeral Preparation Set

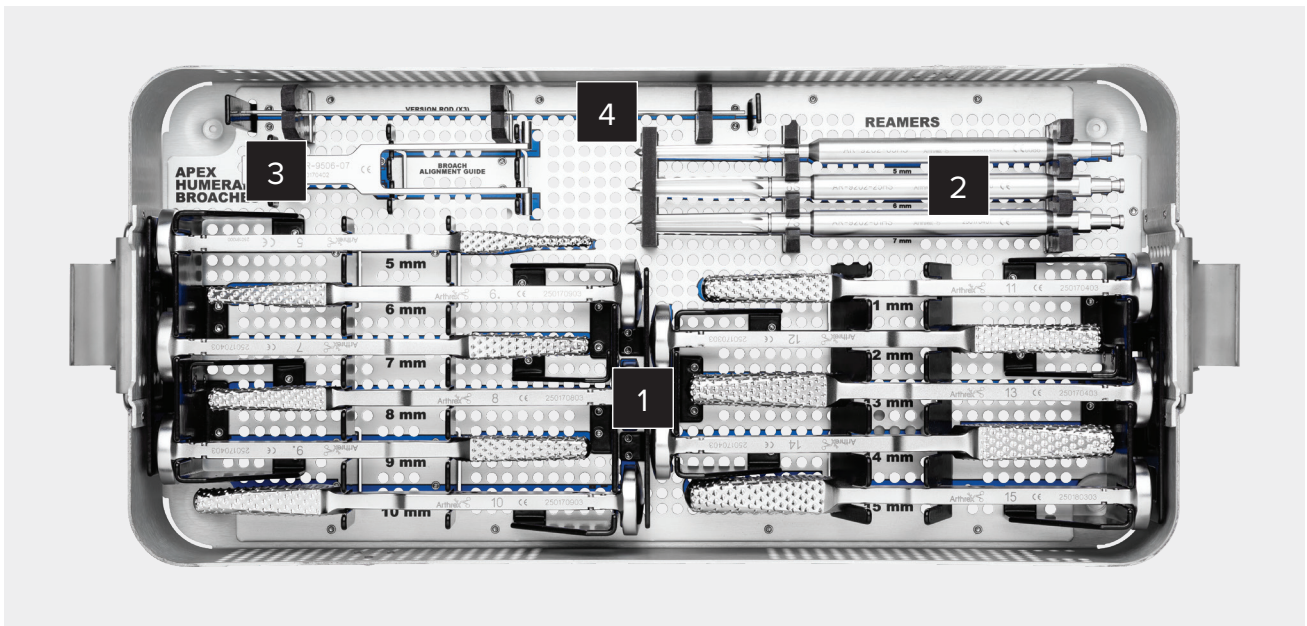

Univers Apex Humeral Preparation Set (AR-9226ABS)

Label	Product Description	Item Number
1	Univers Apex Broach, 5 mm	AR-9231-05S
	Univers Apex Broach, 6 mm	AR-9231-06S
	Univers Apex Broach, 7 mm	AR-9231-07S
	Univers Apex Broach, 8 mm	AR-9231-08S
	Univers Apex Broach, 9 mm	AR-9231-09S
	Univers Apex Broach, 10 mm	AR-9231-10S
	Univers Apex Broach, 11 mm	AR-9231-11S
	Univers Apex Broach, 12 mm	AR-9231-12S
	Univers Apex Broach, 13 mm	AR-9231-13S
	Univers Apex Broach, 14 mm	AR-9231-14S
	Univers Apex Broach, 15 mm	AR-9231-15S
2	Univers Apex Reamer, 5 mm	AR-9202-25HS
	Univers Apex Humeral Reamer, 6 mm	AR-9202-01HS
	Univers Apex Humeral Reamer, 7 mm	AR-9202-02HS
3	Univers Apex Humeral Broach Alignment Guide	AR-9506-07
4	Univers/Eclipse™ Orientation Pin for Resection Guide	AR-9202

Univers™ II/Apex Combined Humeral Preparation

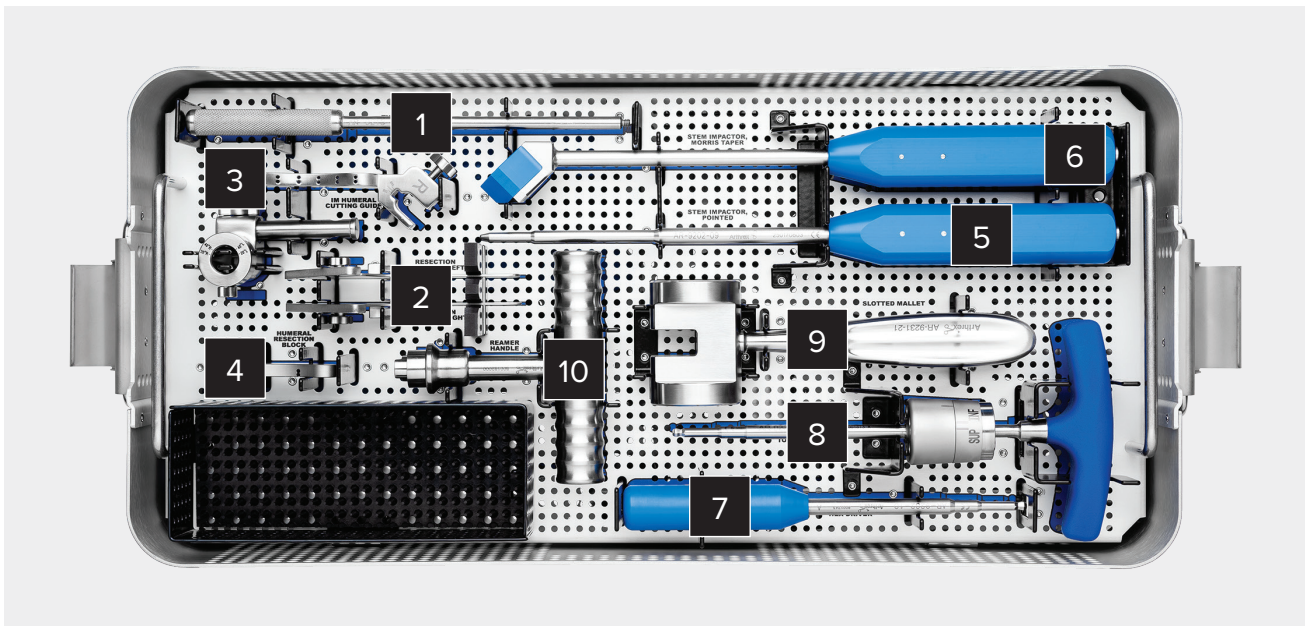

Univers II/Apex Combined Humeral Preparation - Top Tray (AR-9226CC)

Label	Product Description	Item Number
1	Glenoid Drill Guide Handle	AR-9215-1-02
2	Humeral Resection Templates	AR-9200-01L/01R
3	Intramedullary Humeral Cutting Guide	AR-9401-14
4	Univers II/Eclipse Humeral Resection Block	AR-9205
5	Univers II Stem Impactor Pointed	AR-9202-09
6	Univers II Stem Impactor Morse Taper	AR-9202-09P
7	Univers Screwdriver	AR-9202-10
8	Univers II Torque Driver	AR-9224
9	Slotted Mallet, shoulder arthroplasty	AR-9231-21
10	Univers Reamer T-Handle, Hudson connect	AR-9202-15H

Univers™ II/Apex Combined Humeral Set

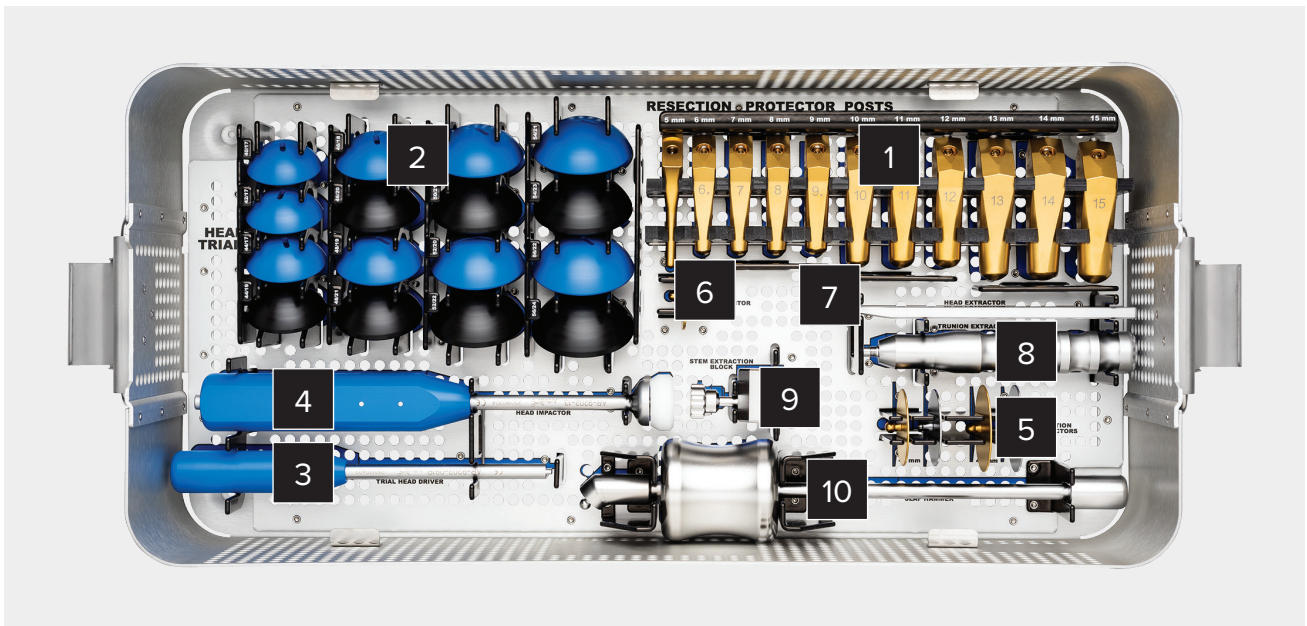

Univers II/Apex Combined Humeral Set - Bottom Tray (AR-9226CS)

Label	Product Description	Item Number	
1	Univers Apex Protector Post, 5 mm	AR-9200-15S	
	Univers Apex Protector Post, 6 mm	AR-9200-16S	
	Univers Apex Protector Post, 7 mm	AR-9200-17S	
	Univers Apex Protector Post, 8 mm	AR-9200-18S	
	Univers Apex Protector Post, 9 mm	AR-9200-19S	
	Univers Apex Protector Post, 10 mm	AR-9200-20S	
	Univers Apex Protector Post, 11 mm	AR-9200-21S	
	Univers Apex Protector Post, 12 mm	AR-9200-22S	
	Univers Apex Protector Post, 13 mm	AR-9200-23S	
	Univers Apex Protector Post, 14 mm	AR-9200-24S	
	Univers Apex Protector Post, 15 mm	AR-9200-25S	
	2	Univers II Trial Head, 40/17	AR-9240-17P
		Univers II Trial Head, 42/17	AR-9242-17P
		Univers II Trial Head, 44/17	AR-9244-19P
Univers II Trial Head, 44/19		AR-9244-19P	
Univers II Trial Head, 46/18		AR-9246-18P	
Univers II Trial Head, 46/20		AR-9246-20P	
Univers II Trial Head, 48/19		AR-9248-19P	
Univers II Trial Head, 48/21		AR-9248-21P	
Univers II Trial Head, 50/19		AR-9250-19P	
Univers II Trial Head, 50/21		AR-9250-21P	
Univers II Trial Head, 52/20		AR-9250-20P	
Univers II Trial Head, 52/22		AR-9252-22P	
Univers II Trial Head, 54/21		AR-9254-21P	
Univers II Trial Head, 54/23		AR-9254-23P	
Univers II Trial Head, 56/22		AR-9256-22P	
Univers II Trial Head, 56/24		AR-9256-24P	
3		Univers II Driver for Trial Head	AR-9202-091P
4	Humeral Head Impactor	AR-9202-13	

Label	Product Description	Item Number
5	Univers II Resection Protector TRL SFT, 40 mm	AR-9202-40SP
	Univers II Resection Protector, 40 mm	AR-9202-40TP
	Univers II Resection Protector TRL SFT, 45 mm	AR-9202-45SP
	Univers II Resection Protector, 45 mm	AR-9202-45TP
6	Univers II Trial Trunnion	AR-9202-27
7	Humeral Head Extractor	AR-9401-17
8	Univers II Trunnion Extractor	AR-9202-38P
9	Univers II Stem Extractor	AR-9202-41P
10	Univers Slap Hammer	AR-9202-14

Optional

Product Description	Item Number
Version Rod Bracket	AR-9231-20
Intramedullary Humeral Cutting Guide	AR-9401-14

Univers™ CA Humeral Head Instrument Set

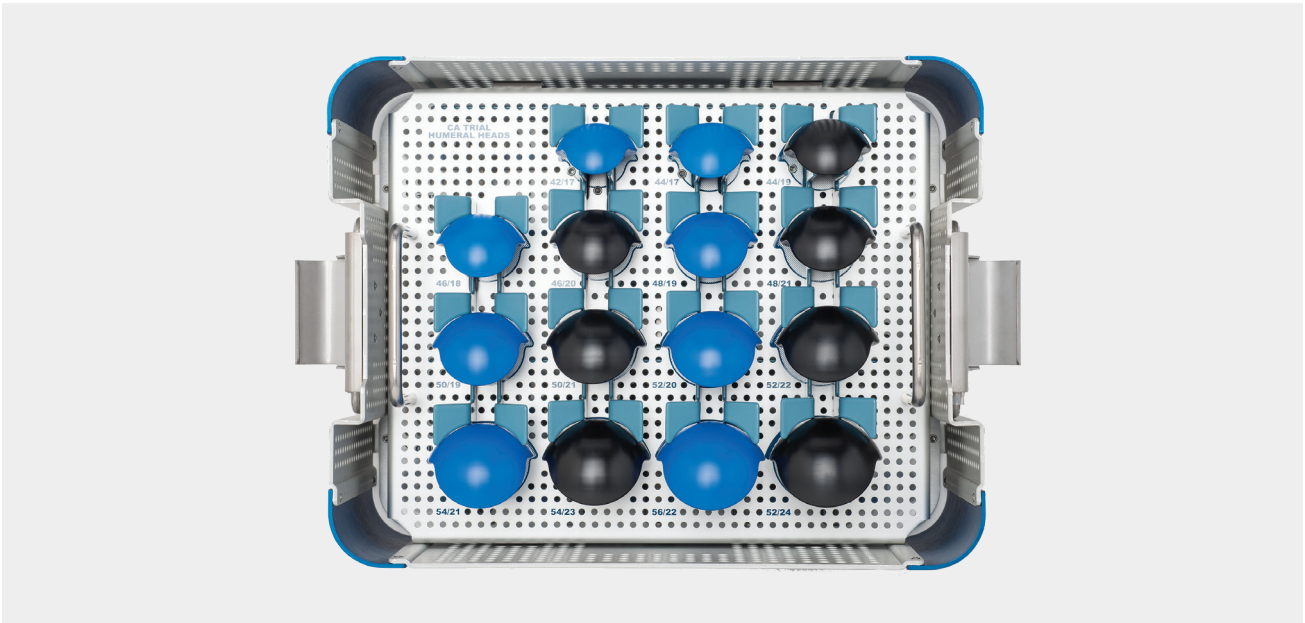

Univers CA Humeral Head Instrument Set - Top Tray (AR-9200CAS)

Product Description	Item Number
Univers CA Trial Head, 42/17	AR-9242-17CA
Univers CA Trial Head, 44/17	AR-9244-17CA
Univers CA Trial Head, 44/19	AR-9244-19CA
Univers CA Trial Head, 46/18	AR-9246-18CA
Univers CA Trial Head, 46/20	AR-9246-20CA
Univers CA Trial Head, 48/19	AR-9248-19CAG
Univers CA Trial Head, 48/21	AR-9248-21CA
Univers CA Trial Head, 50/19	AR-9250-19CA
Univers CA Trial Head, 50/21	AR-9250-21CA
Univers CA Trial Head, 52/20	AR-9252-20CA
Univers CA Trial Head, 52/22	AR-9252-22CAG
Univers CA Trial Head, 54/21	AR-9254-21CA
Univers CA Trial Head, 54/23	AR-9254-23CA
Univers CA Trial Head, 56/22	AR-9256-22CA
Univers CA Trial Head, 56/24	AR-9256-24CA

Univers™ CA Humeral Head Instrument Set (Cont.)

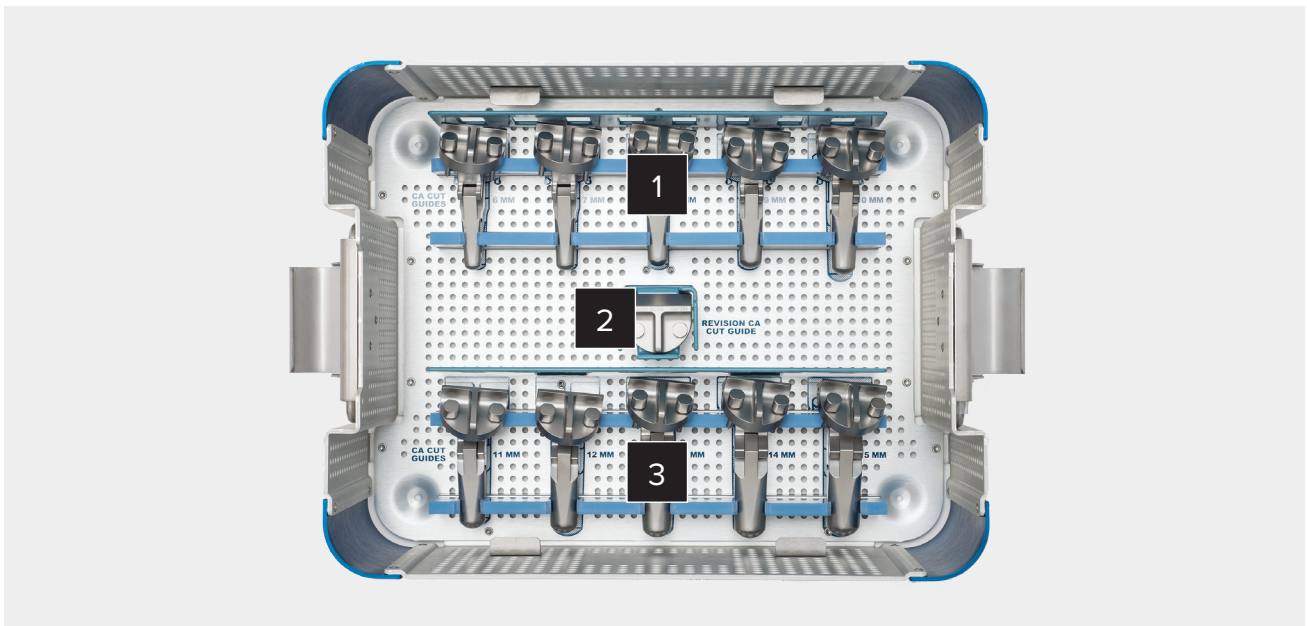

Univers CA Humeral Head Instrument Set – Bottom Tray (AR-9200CAS)

Label	Product Description	Item Number
1	CA Cut Guide, size 6	AR-9200-16CA
	CA Cut Guide, size 7	AR-9200-17CA
	CA Cut Guide, size 8	AR-9200-18CA
	CA Cut Guide, size 9	AR-9200-19CA
	CA Cut Guide, size 10	AR-9200-20CA
2	Revision CA Cut Guide	AR-9200-16CAG
3	CA Cut Guide, size 11	AR-9200-21CA
	CA Cut Guide, size 12	AR-9200-22CA
	CA Cut Guide, size 13	AR-9200-23CA
	CA Cut Guide, size 14	AR-9200-24CA
	CA Cut Guide, size 15	AR-9200-25CA

Univers VaultLock® Glenoid System



Fluted Central Peg

- Immediate fixation
- OR efficiency

Anatomic Backside Radius of Curvature (ROC)

- Matches glenoid poly to glenoid anatomy
- Subchondral bone-sparing reaming
- Simplified decision-making

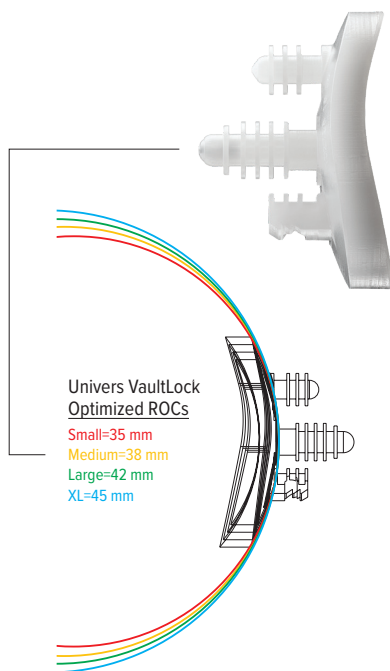

Inferior Keel

- Decreased cortical penetration compared to inferior pegs
- Multiple fixation features, including reverse barbs, flutes, and central cement fenestration

Superior Peg

- Enhanced immediate fixation
- Self-pressurizing design

Inline Configuration

- Combines all advantages of pegged and keeled implants, including stability and ease of preparation

Implants

Product Description	Item Number
Univers VaultLock Glenoid, small	AR-9106-01
Univers VaultLock Glenoid, medium	AR-9106-02
Univers VaultLock Glenoid, large	AR-9106-03
Univers VaultLock Glenoid, extra large	AR-9106-04

Disposables

Product Description	Item Number
DynaNite® Virtual Implant Positioning™ Glenoid Pin, nitinol, 2.8 mm	AR-5400N-400NS
Eclipse™ and Univers™ II Pin Set	AR-9207S

Keeled Glenoid



Cemented Glenoid Reconstruction

- Keel with dual fenestration for improved cement acceptance
- Reverse barbs on the keel for enhanced anchoring

Implants

Product Description	Item Number
Keeled Glenoid, cemented, small	AR-9104-01
Keeled Glenoid, cemented, medium	AR-9104-02
Keeled Glenoid, cemented, large	AR-9104-03
Keeled Glenoid, cemented, extra large	AR-9104-04

Univers VaultLock® and Keel Glenoid Instrument Set

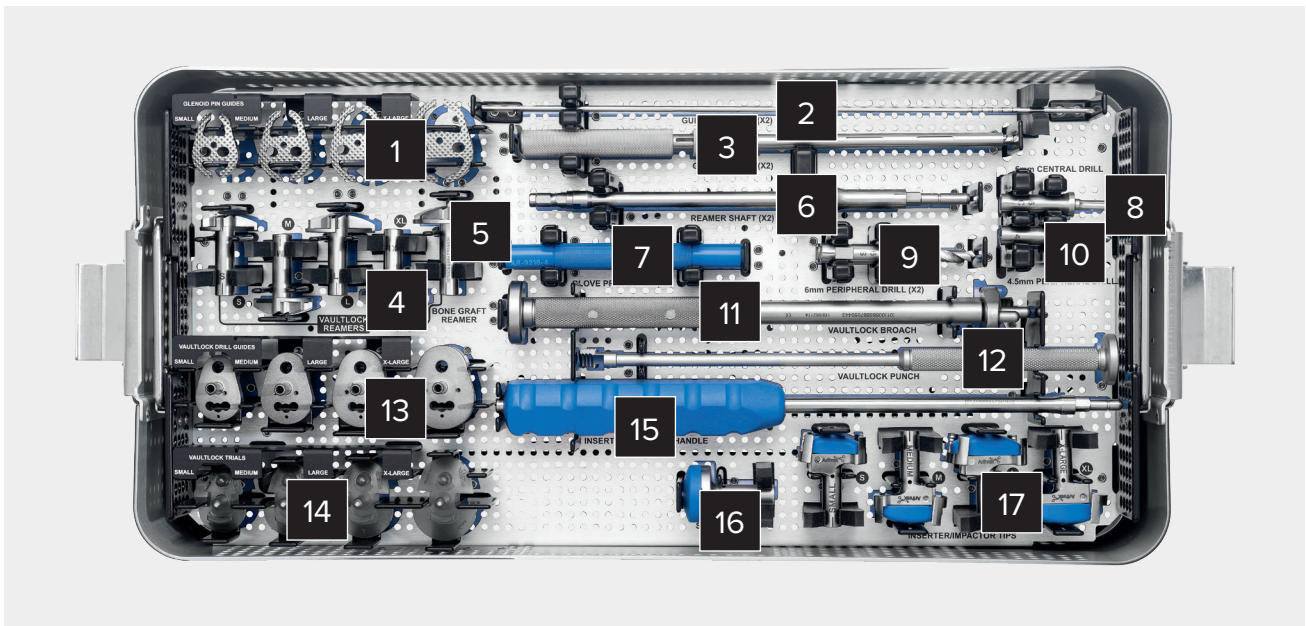

Univers VaultLock and Keel Glenoid Instrument Set - Top Tray (AR-9217VKS)

Label	Product Description	Item Number
1	Univers VaultLock/Keel Glenoid Pin Guide, quick connect, small Univers VaultLock/Keel Glenoid Pin Guide, quick connect, medium Univers VaultLock/Keel Glenoid Pin Guide, quick connect, large Univers VaultLock/Keel Glenoid Pin Guide, quick connect, extra large	AR-9215-VK-1 AR-9215-VK-2 AR-9215-VK-3 AR-9215-VK-4
2	Steinmann Pin, 2.8 mm	AR-9207
3	Quick-Connect Handle	AR-9215-1-03
4	Modular Univers VaultLock Reamer, small Modular Univers VaultLock Reamer, medium Modular Univers VaultLock Reamer, large Modular Univers VaultLock Reamer, extra large	AR-9228AG AR-9229AG AR-9230AG AR-9231AG
5	Modular Bone Graft Reamer	AR-9229-VLG
6	Quick-Connect Drive Shaft	AR-9617
7	Glove Protector	AR-9216-4
8	Modular Cannulated Central Drill, 6 mm	AR-9216AG
9	Modular Superior Drill, 6 mm	AR-9221AG
10	Modular Inferior Drill, 4.5 mm	AR-9239AG
11	Glenoid Broach	AR-9233
12	Glenoid Punch	AR-9234
13	Univers VaultLock Drill Guide, quick connect, small Univers VaultLock Drill Guide, quick connect, medium Univers VaultLock Drill Guide, quick connect, large Univers VaultLock Drill Guide, quick connect, extra large	AR-9231-VL-01 AR-9231-VL-02 AR-9231-VL-03 AR-9231-VL-04
14	Univers VaultLock Glenoid Trial, small Univers VaultLock Glenoid Trial, medium Univers VaultLock Glenoid Trial, large Univers VaultLock Glenoid Trial, extra large	AR-9236-01PP AR-9236-02PP AR-9236-03PP AR-9236-04PP
15	Glenoid Inserter/Impactor Handle	AR-9241-2
16	Secondary Glenoid Impactor	AR-9241-00
17	Glenoid Inserter/Impactor, small Glenoid Inserter/Impactor, medium Glenoid Inserter/Impactor, large Glenoid Inserter/Impactor, extra large	AR-9241-01 AR-9241-02 AR-9241-03 AR-9241-04

Univers VaultLock® and Keel Glenoid Instrument Set (Cont.)

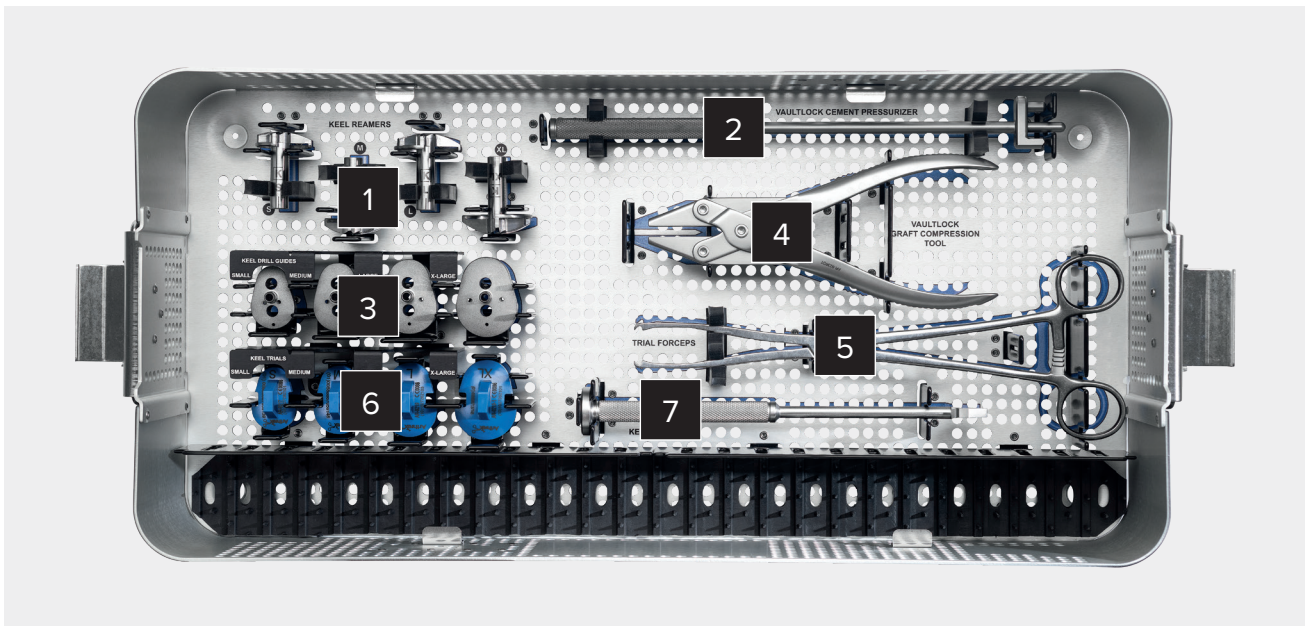

Univers VaultLock and Keel Glenoid Instrument Set - Bottom Tray (AR-9217VKS)

Label	Product Description	Item Number
1	Modular Nautilus Reamer, small Modular Nautilus Reamer, medium Modular Nautilus Reamer, large Modular Nautilus Reamer, extra large	AR-9228NRM AR-9229NRM AR-9230NRM AR-9231NRM
2	Cement Pressurizer	AR-9235
3	Keel Glenoid Drill Guide, quick connect, small Keel Glenoid Drill Guide, quick connect, medium Keel Glenoid Drill Guide, quick connect, large Keel Glenoid Drill Guide, quick connect, extra large	AR-9215-K-3 AR-9215-K-5 AR-9215-K-7 AR-9215-K-9
4	Graft Compression Tool	AR-9236GT
5	Glenoid Trial Forceps	AR-9238
6	Keel Glenoid Trial, small Keel Glenoid Trial, medium Keel Glenoid Trial, large Keel Glenoid Trial, extra large	AR-9217 AR-9218 AR-9219 AR-9219-1
7	Keel Glenoid Punch	AR-9214

Univers VaultLock® Augmented Glenoid System



Fluted Central Peg

- Immediate fixation
- OR efficiency

Anatomic Backside Radius of Curvature (ROC)

- Matches glenoid poly to glenoid anatomy
- Subchondral bone-sparing reaming
- Simplified decision-making

Superior Peg

- Enhanced immediate fixation
- Self-pressurizing design

Inline Configuration

- Combines all advantages of pegged and keeled implants including stability and preparation ease

Inferior Keel

- Decreased cortical penetration compared to inferior pegs
- Multiple fixation features, including reverse barbs, flutes, and central cement fenestration

Augmented Sizes

- 15° and 25° half-wedge options available for bone preservation

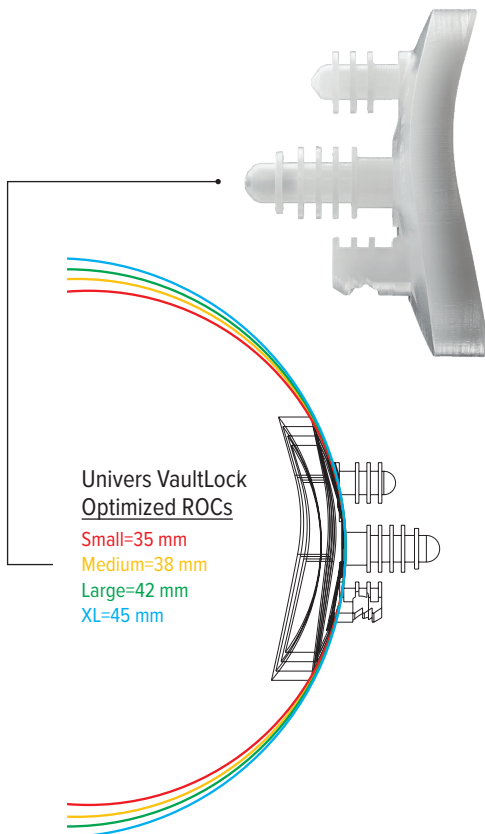

Univers VaultLock
Optimized ROCs

Small=35 mm

Medium=38 mm

Large=42 mm

XL=45 mm

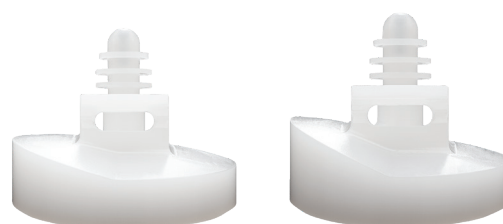

Univers VaultLock® Augmented Glenoid System (Cont.)

Implants

Product Description	Item Number
Augmented Univers VaultLock Glenoid, 15°, left, small	AR-9107-01-15L
Augmented Univers VaultLock Glenoid, 15°, left, medium	AR-9107-02-15L
Augmented Univers VaultLock Glenoid, 15°, left, large	AR-9107-03-15L
Augmented Univers VaultLock Glenoid, 15°, left, extra large	AR-9107-04-15L
Augmented Univers VaultLock Glenoid, 15°, right, small	AR-9107-01-15R
Augmented Univers VaultLock Glenoid, 15°, right, medium	AR-9107-02-15R
Augmented Univers VaultLock Glenoid, 15°, right, large	AR-9107-03-15R
Augmented Univers VaultLock Glenoid, 15°, right, extra large	AR-9107-04-15R
Augmented Univers VaultLock Glenoid, 25°, left, small	AR-9107-01-25L
Augmented Univers VaultLock Glenoid, 25°, left, medium	AR-9107-02-25L
Augmented Univers VaultLock Glenoid, 25°, left, large	AR-9107-03-25L
Augmented Univers VaultLock Glenoid, 25°, left, extra large	AR-9107-04-25L
Augmented Univers VaultLock Glenoid, 25°, right, small	AR-9107-01-25R
Augmented Univers VaultLock Glenoid, 25°, right, medium	AR-9107-02-25R
Augmented Univers VaultLock Glenoid, 25°, right, large	AR-9107-03-25R
Augmented Univers VaultLock Glenoid, 25°, right, extra large	AR-9107-04-25R

Disposables

Product Description	Item Number
Angled Reamer, small	AR-9275-S
Angled Reamer, medium	AR-9275-M
Angled Reamer, large	AR-9275-L
DynaNite® Virtual Implant Positioning™ Glenoid Pin, nitinol, 2.8 mm	AR-5400-400NS
Eclipse™ and Univers™ II Pin Set	AR-9207S

Univers VaultLock® Augmented Glenoid Instrument Set

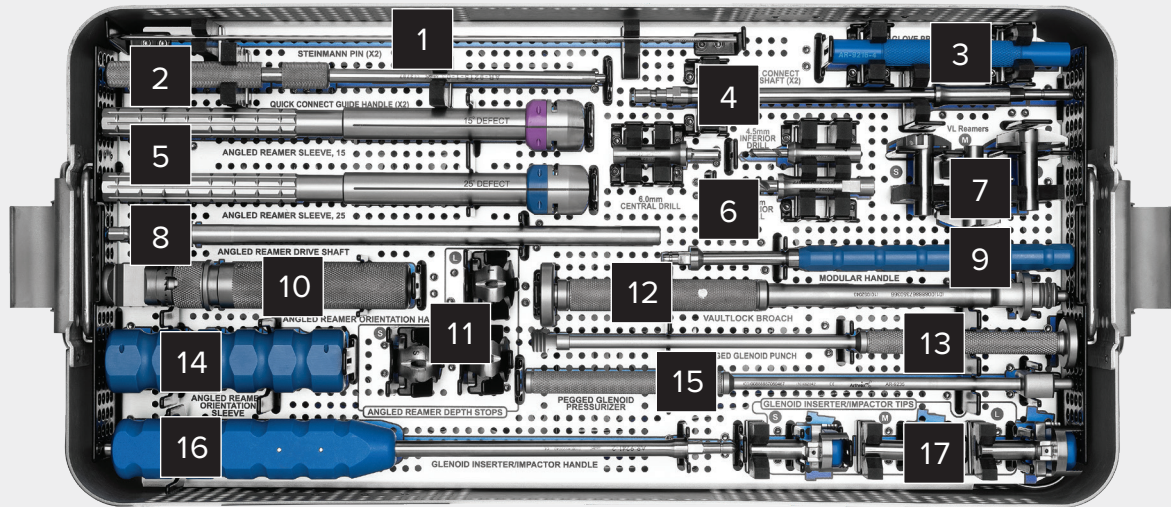

Univers VaultLock Augmented Glenoid Instrument Set - Top Tray (AR-9217AVS)

Label	Product Description	Item Number
1	2.8 mm Steinmann Pin	AR-9207
2	Quick-Connect Handle	AR-9215-1-03
3	Glove Protector	AR-9216-4
4	Quick-Connect Drive Shaft	AR-9617
5	Angled Reamer Sleeve, 15° Angled Reamer Sleeve, 25°	AR-9297-15 AR-9297-25
6	6.0 mm Central Drill 4.5 mm Inferior Drill 6.0 mm Superior Drill	AR-9216AG AR-9239AG AR-9221AG
7	Modular Reamer, small Modular Reamer, medium Modular Reamer, large	AR-9228AG AR-9229AG AR-9230AG
8	Angled Reamer Drive Shaft	AR-9676
9	Modular Handle	AR-9595
10	Angled Reamer Orientation Handle	AR-9678
11	Angled Reamer Depth Stop, small Angled Reamer Depth Stop, medium Angled Reamer Depth Stop, large	AR-9298-S AR-9298-M AR-9298-L
12	Univers VaultLock Augmented Broach	AR-9233AG
13	Pegged Glenoid Punch	AR-9234
14	Angled Reamer Orientation Sleeve	AR-9679
15	Pegged Glenoid Pressurizer	AR-9235
16	Glenoid Inserter/Impactor Handle	AR-9241-2
17	Glenoid Inserter/Impactor, small Glenoid Inserter/Impactor, medium Glenoid Inserter/Impactor, large	AR-9241-01 AR-9241-02 AR-9241-03

Uniers VaultLock® Augmented Glenoid Instrument Set (Cont.)

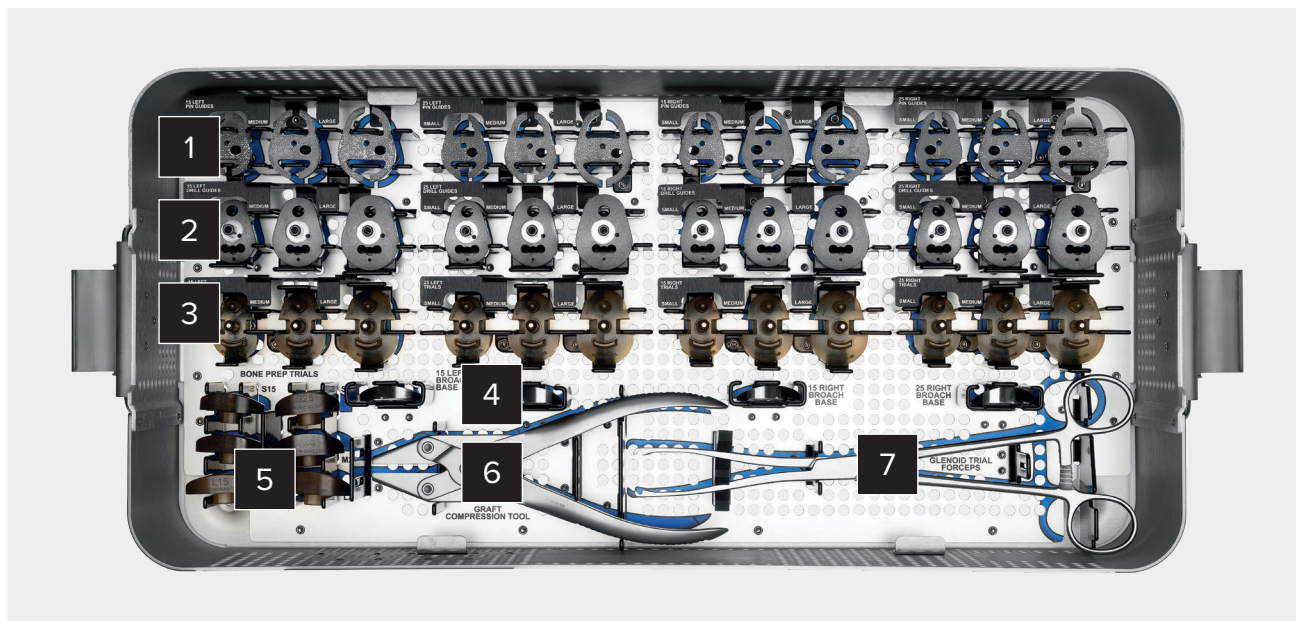

Uniers VaultLock Augmented Glenoid Instrument Set - Bottom Tray (AR-9217AVS)

Label	Product Description	Item Number
1	Augmented Uniers VaultLock Pin Guide, 15° left (small, medium, large) Augmented Uniers VaultLock Pin Guide, 25° left (small, medium, large) Augmented Uniers VaultLock Pin Guide, 15° right (small, medium, large) Augmented Uniers VaultLock Pin Guide, 25° right (small, medium, large)	AR-9215-2AG/4AG/6AG-15L AR-9215-2AG/4AG/6AG-25L AR-9215-2AG/4AG/6AG-15R AR-9215-2AG/4AG/6AG-25R
2	Augmented Uniers VaultLock Drill Guide, 15° left (small, medium, large) Augmented Uniers VaultLock Drill Guide, 25° left (small, medium, large) Augmented Uniers VaultLock Drill Guide, 15° right (small, medium, large) Augmented Uniers VaultLock Drill Guide, 25° right (small, medium, large)	AR-9231-01AG/02AG/03AG-15L AR-9231-01AG/02AG/03AG-25L AR-9231-01AG/02AG/03AG-15R AR-9231-01AG/02AG/03AG-25R
3	Augmented Uniers VaultLock Trial, 15° left (small, medium, large) Augmented Uniers VaultLock Trial, 25° left (small, medium, large) Augmented Uniers VaultLock Trial, 15° right (small, medium, large) Augmented Uniers VaultLock Trial, 25° right (small, medium, large)	AR-9236-01AG/02AG/03AG-15L AR-9236-01AG/02AG/03AG-25L AR-9236-01AG/02AG/03AG-15R AR-9236-01AG/02AG/03AG-25R
4	Augmented Uniers VaultLock Broach Base, 15° left Augmented Uniers VaultLock Broach Base, 25° left Augmented Uniers VaultLock Broach Base, 15° right Augmented Uniers VaultLock Broach Base, 25° right	AR-9233AG-15L AR-9233AG-25L AR-9233AG-15R AR-9233AG-25R
5	Augmented Uniers VaultLock Bone Prep Trial, small (15°, 25°) Augmented Uniers VaultLock Bone Prep Trial, medium (15°, 25°) Augmented Uniers VaultLock Bone Prep Trial, large (15°, 25°)	AR-9236-01AG-15BP/25BP AR-9236-02AG-15BP/25BP AR-9236-03AG-15BP/25BP
6	Graft Compression Tool	AR-9236GT
7	Glenoid Trial Forceps	AR-9238

Univers VaultLock® Augmented Glenoid XL Instrument Set

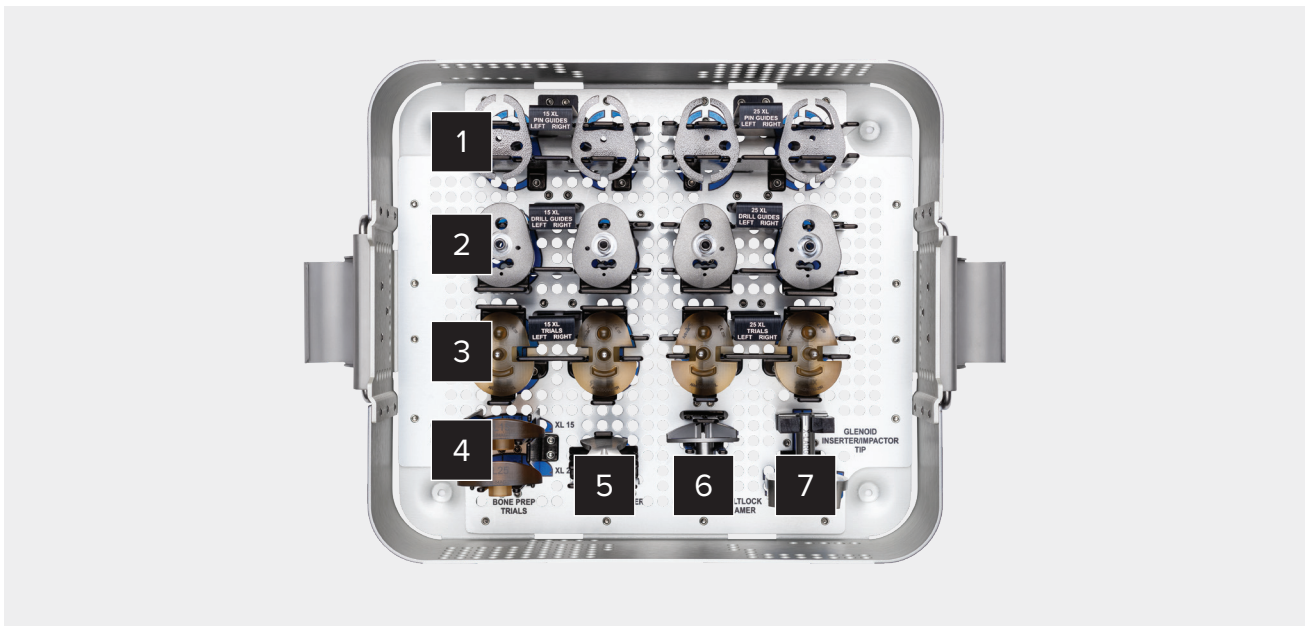

Univers VaultLock Augmented Glenoid XL Instrument Set (AR-9217AVXLS)

Label	Product Description	Item Number
1	Augmented Univers VaultLock Pin Guide, x-large, 15° left	AR-9215-8AG-15L
	Augmented Univers VaultLock Pin Guide, x-large, 15° right	AR-9215-8AG-15R
	Augmented Univers VaultLock Pin Guide, x-large, 25° left	AR-9215-8AG-25L
	Augmented Univers VaultLock Pin Guide, x-large, 25° right	AR-9215-8AG-25R
2	Augmented Univers VaultLock Drill Guide, x-large, 15° left	AR-9231-04AG-15L
	Augmented Univers VaultLock Drill Guide, x-large, 15° right	AR-9231-04AG-15R
	Augmented Univers VaultLock Drill Guide, x-large, 25° left	AR-9231-04AG-25L
	Augmented Univers VaultLock Drill Guide, x-large, 25° right	AR-9231-04AG-25R
3	Augmented Univers VaultLock Trial, x-large, 15° left	AR-9236-04AG-15L
	Augmented Univers VaultLock Trial, x-large, 15° right	AR-9236-04AG-15R
	Augmented Univers VaultLock Trial, x-large, 25° left	AR-9236-04AG-25L
	Augmented Univers VaultLock Trial, x-large, 25° right	AR-9236-04AG-25R
4	Bone Prep Trial, x-large, 15°	AR-9236-04AG-15BP
	Bone Prep Trial, x-large, 25°	AR-9236-04AG-25BP
5	Angled Reamer Depth Stop, x-large	AR-9298-XL
6	Modular Reamer, x-large	AR-9231AG
7	Glenoid Inserter/Impactor, x-large	AR-9241-04

Universal Glenoid™ Convertible Baseplate

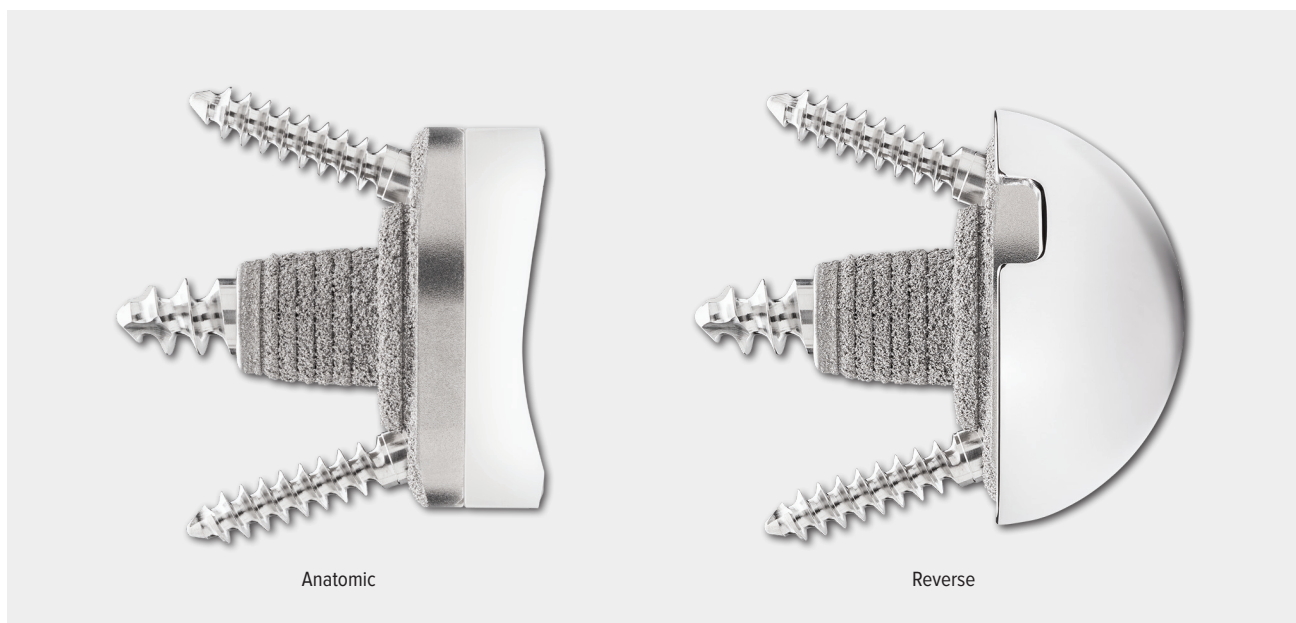

Convertible Cementless Glenoid Reconstruction

- Baseplate may be combined with an anatomic polyethylene inlay for the advantages of anatomic reconstruction with the stability of screw fixation
- With the addition of a glenosphere to an existing baseplate, anatomic reconstructions can be conveniently converted to a reverse prosthesis
- Facilitates 0°-20° of version correction possibilities

Implants

Product Description	Item Number
Universal Glenoid Baseplate, small	AR-9120-01PC
Universal Glenoid Baseplate, medium	AR-9120-02PC
Universal Glenoid Baseplate, large	AR-9120-03PC
Universal Glenoid Inlay, small	AR-9121-01
Universal Glenoid Inlay, medium	AR-9121-02
Universal Glenoid Inlay, large	AR-9121-03
Universal Glenoid Inlay, small PLUS	AR-9121-04
Universal Glenoid Inlay, medium PLUS	AR-9121-05
Universal Glenoid Inlay, large PLUS	AR-9121-06
Universal Glenoid Glensphere, 42	AR-9504L
Universal Glenoid Glensphere, 42+4 LAT	AR-9504L-04
Universal Glenoid Glensphere, 42+2.5 INF	AR-9504M-02
Universal Glenoid Glensphere, 39	AR-9504M
Universal Glenoid Glensphere, 39+4 LAT	AR-9504M-04
Universal Glenoid Glensphere, 39+2.5 INF	AR-9504S-02
Universal Glenoid Glensphere, 36	AR-9504S
Universal Glenoid Glensphere, 36+4 LAT	AR-9504S-04
Universal Glenoid Glensphere, 36+2.5 INF	AR-9504S-INF
Universal Glenoid Peripheral Locking Screw, 24 mm	AR-9145-24
Universal Glenoid Peripheral Locking Screw, 30 mm	AR-9145-30
Universal Glenoid Peripheral Locking Screw, 36 mm	AR-9145-36
Universal Glenoid Peripheral Locking Screw, 42 mm	AR-9145-42
Universal Glenoid Peripheral Locking Screw, 48 mm	AR-9145-48
Universal Glenoid Central Screw, 15 mm	AR-9165-15
Universal Glenoid Central Screw, 20 mm	AR-9165-20
Universal Glenoid Central Screw, 25 mm	AR-9165-25

Product Description	Item Number
Univers Revers™ Peripheral Screw, nonlocking, 4.5 mm × 24 mm	AR-9145-24NL
Univers Revers Peripheral Screw, nonlocking, 4.5 mm × 30 mm	AR-9145-30NL
Univers Revers Peripheral Screw, nonlocking, 4.5 mm × 36 mm	AR-9145-36NL
Univers Revers Peripheral Screw, nonlocking, 4.5 mm × 42 mm	AR-9145-42NL
Univers Revers Peripheral Screw, nonlocking, 4.5 mm × 48 mm	AR-9145-48NL
Univers Revers Central Screw, nonlocking, 6.5 mm × 15 mm	AR-9165-15NL
Univers Revers Central Screw, nonlocking, 6.5 mm × 20 mm	AR-9165-20NL
Univers Revers Central Screw, nonlocking, 6.5 mm × 25 mm	AR-9165-25NL

Universal Glenoid™ Instrument Set

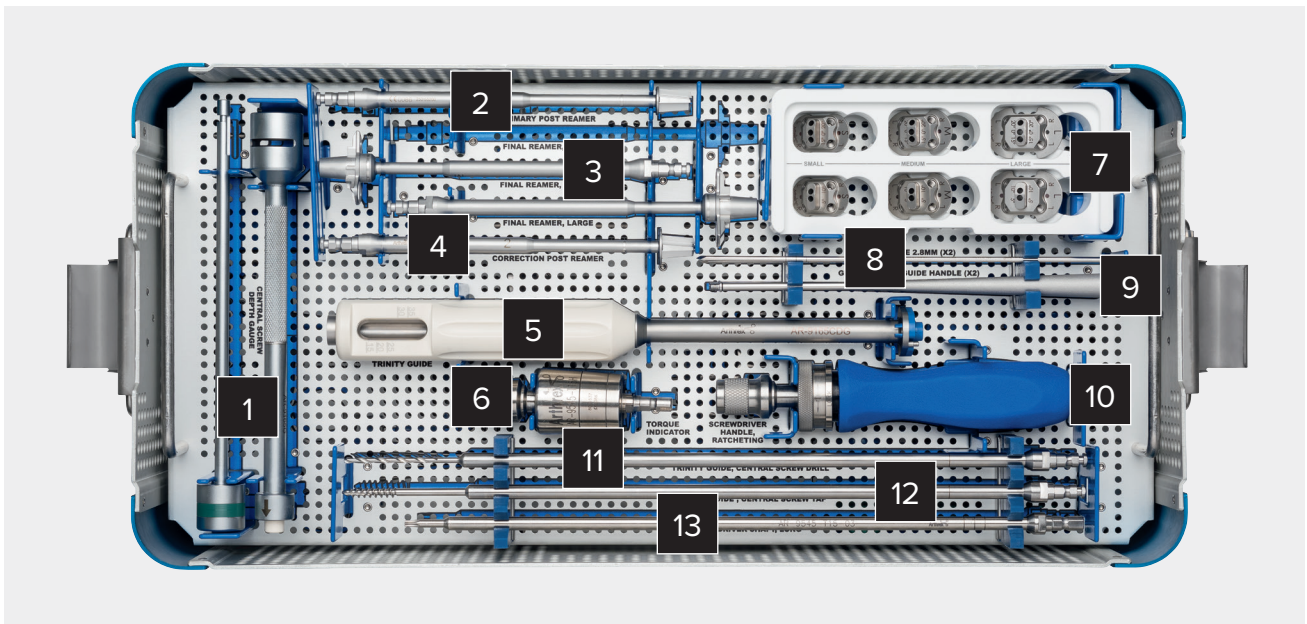

Universal Glenoid Instrument Set - Top Tray (AR-9501GS)

Label	Product Description	Item Number
1	Central Screw Depth Gauge	AR-9165G
2	Primary Post Reamer	AR-9126RP
3	Final Reamer, small Final Reamer, medium Final Reamer, large	AR-9126-01 AR-9126-02 AR-9126-03
4	Correction Post Reamer	AR-9126RC
5	Universal Glenoid Baseplate Impactor (Trinity Guide)	AR-9165CDG
6	Torque Indicating Adapter	AR-9545-T15H
7	Glenoid Drill Guides, small Glenoid Drill Guides, medium Glenoid Drill Guides, large	AR-9125-1/AR-9125-10 AR-9125-2/AR-9125-20 AR-9125-3/AR-9125-30
8	2.8 mm Guide Pin, qty. 2	AR-9165K
9	Glenoid Drill Guide Handle	AR-9125H
10	Ratcheting Modular Handle	AR-1999HH
11	Baseplate Impactor Drill, 2.8 mm	AR-9165DDG
12	Baseplate Impactor Central Screw Tap	AR-9165TDG
13	T15 Driver Shaft, long	AR-9545-T15-03

Universal Glenoid™ Instrument Set (Cont.)

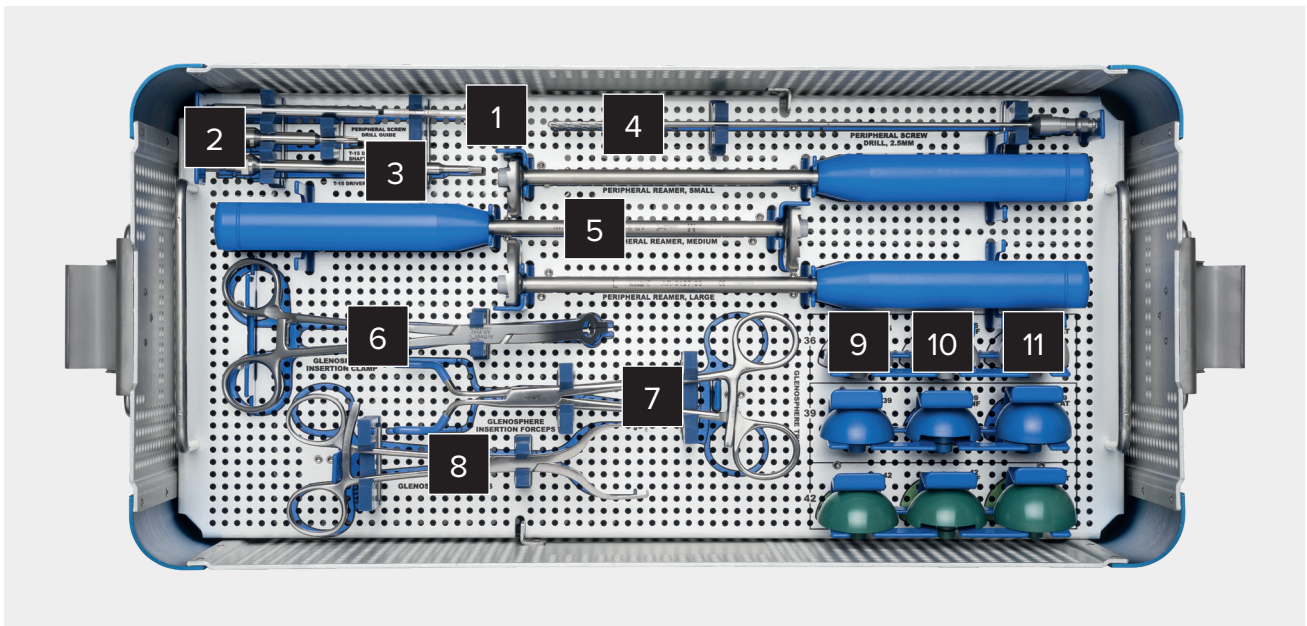

Universal Glenoid Instrument Set - Middle Tray (AR-9501GS)

Label	Product Description	Item Number
1	Peripheral Screw Drill Guide	AR-9145DG
2	T15 Driver Shaft, short	AR-9545-T15-01
3	T15 Driver Shaft, medium	AR-9545-T15-02
4	Peripheral Screw Drill, 2.5 mm	AR-9145K
5	Baseplate Coring Reamer, small Baseplate Coring Reamer, medium Baseplate Coring Reamer, large	AR-9127-01 AR-9127-02 AR-9127-03
6	Glenosphere Inserter	AR-9542
7	Glenoid Forceps	AR-9240
8	Glenosphere Forceps	AR-9544
9	Trial Glenospheres, 36 mm	AR-9540SM, AR-9540SM-INF, AR-9540SM-04
10	Trial Glenospheres, 39 mm	AR-9540MD, AR-9540SM-02, AR-9540MD-04
11	Trial Glenospheres, 42 mm	AR-9540LG, AR-9540MD-02, AR-9540LG-04

Universal Glenoid™ Instrument Set (Cont.)

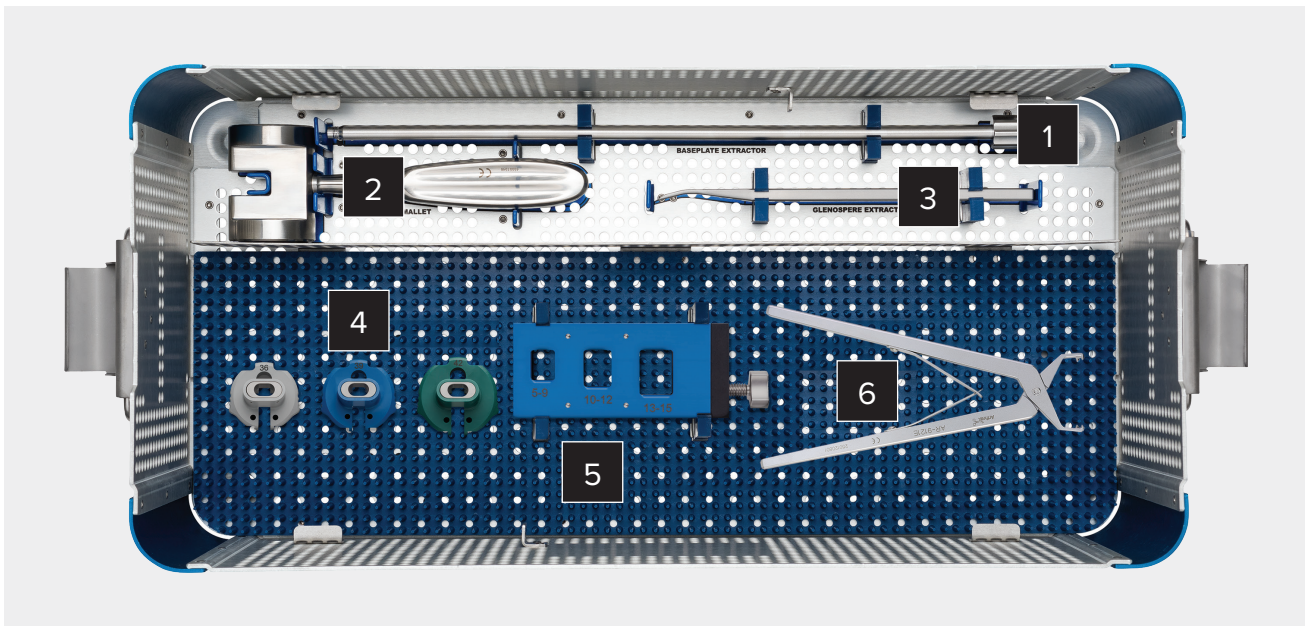

Universal Glenoid Instrument Set - Bottom Tray (AR-9501GS)

Label	Product Description	Item Number
1	Baseplate Extractor	AR-9120E
2	Slotted Mallet	AR-9231-21
3	Glenosphere Extractor/Chisel	AR-9123GE
4	Cup Alignment Guides	AR-9532-36/39/42
5	Revers Humeral Assembly Station	AR-9532
6	Universal Glenoid Inlay Extractor	AR-9121E

Univers Revers™ Total Shoulder System

Humeral Stems

- Rectangular proximal filling stem based on anatomic geometry of Univers™ II total shoulder system
- Calcium phosphate (HA or CaP)-coated proximal stem
- 1 mm size increments for optimized press-fit
- Traditional-length stems from 95 mm to 147 mm
- Univers Revers Apex stems from 60 mm to 65 mm
- 135° and 155° inclination angles in one universal stem body



Univers Revers™ Total Shoulder System (Cont.)

SutureCups, Liners, and Spacers

- 33 mm, 36 mm, 39 mm, and 42 mm options
- Suture holes for tuberosity and rotator cuff attachment
- Calcium phosphate (CaP)-coated cup
- Centered and offset options for bone preservation and anatomic placement
- 2 polyethylene liners and 4 titanium spacer thicknesses for optional soft-tissue balancing
- Standard and constrained liner options
- Combination liners allow upsizing the glenosphere by one size in respect to the humeral cup
- Adapters available for revision to anatomic hemi-shoulder replacement with cuff arthropathy (CA) humeral head



Univers Revers™ Total Shoulder System (Cont.)

Implants

Product Description	Item Number
Stems	
Univers Revers Stem, size 4/33, monoblock 135°	AR-9501-04-135P
Univers Revers Stem, size 5	AR-9501-05P
Univers Revers Stem, size 6	AR-9501-06P
Univers Revers Stem, size 7	AR-9501-07P
Univers Revers Stem, size 8	AR-9501-08P
Univers Revers Stem, size 9	AR-9501-09P
Univers Revers Stem, size 10	AR-9501-10P
Univers Revers Stem, size 11	AR-9501-11P
Univers Revers Stem, size 12	AR-9501-12P
Univers Revers Stem, size 13	AR-9501-13P
Univers Revers Stem, size 14	AR-9501-14P
Univers Revers Stem, size 15	AR-9501-15P
Univers Revers Stem, size 6, revision (180 mm)	AR-9501-06RCPC
Univers Revers Stem, size 9, revision (180 mm)	AR-9501-09RCPC
Univers Revers Stem, size 12, revision (180 mm)	AR-9501-12RCPC
Univers Revers Apex Stem, 6	AR-9501-06S
Univers Revers Apex Stem, 7	AR-9501-07S
Univers Revers Apex Stem, 8	AR-9501-08S
Univers Revers Apex Stem, 9	AR-9501-09S
Univers Revers Apex Stem, 10	AR-9501-10S
Univers Revers Apex Stem, 11	AR-9501-11S
Univers Revers Apex Stem, 12	AR-9501-12S
Univers Revers Apex Stem, 13	AR-9501-13S
Univers Revers Apex Stem, 14	AR-9501-14S
Univers Revers Apex Stem, 15	AR-9501-15S
SutureCups	
Univers Revers SutureCup, 33 (neutral)	AR-9502F-33CPC
Univers Revers SutureCup, 33 (+2 mm left)	AR-9502F-33LCPC
Univers Revers SutureCup, 33 (+2 mm right)	AR-9502F-33RCPC
Univers Revers SutureCup, 36 (neutral)	AR-9502F-36CPC
Univers Revers SutureCup, 36 (+2 mm left)	AR-9502F-36LCPC
Univers Revers SutureCup, 36 (+2 mm right)	AR-9502F-36RCPC
Univers Revers SutureCup, 39 (neutral)	AR-9502F-39CPC
Univers Revers SutureCup, 39 (+2 mm left)	AR-9502F-39LCPC
Univers Revers SutureCup, 39 (+2 mm right)	AR-9502F-39RCPC
Univers Revers SutureCup, 42 (neutral)	AR-9502F-42CPC
Univers Revers SutureCup, 42 (+2 mm left)	AR-9502F-42LCPC
Univers Revers SutureCup, 42 (+2 mm right)	AR-9502F-42RCPC
Humeral Inserts	
Humeral Insert, 33+3 mm	AR-9503XS-03
Humeral Insert, 33+6 mm	AR-9503XS-06
Humeral Insert, 33+3 mm, constrained	AR-9503XS-03C
Humeral Insert, 33+6 mm, constrained	AR-9503XS-06C
Humeral Insert, 42+3 mm	AR-9503L-03
Humeral Insert, 42+3 mm, constrained	AR-9503L-03C
Humeral Insert, 42+6 mm	AR-9503L-06
Humeral Insert, 42+6 mm, constrained	AR-9503L-06C
Humeral Insert, 39+3 mm	AR-9503M-03
Humeral Insert, 39+3 mm, constrained	AR-9503M-03C
Humeral Insert, 39+6 mm	AR-9503M-06
Humeral Insert, 39+6 mm, constrained	AR-9503M-06C

Product Description	Item Number
Humeral Insert, 36+3 mm	AR-9503S-03
Humeral Insert, 36+3 mm, constrained	AR-9503S-03C
Humeral Insert, 36+6 mm	AR-9503S-06
Humeral Insert, 36+6 mm, constrained	AR-9503S-06C
Humeral Spacers	
Humeral Spacer, 33+6 mm	AR-9504-06
Humeral Spacer, 33+9 mm	AR-9504-09
Humeral Spacer, 33+12 mm	AR-9504-12
Humeral Spacer, 33+15 mm	AR-9504-15
Humeral Spacer, 39+6 mm	AR-9505-06
Humeral Spacer, 39+9 mm	AR-9505-09
Humeral Spacer, 39+12 mm	AR-9505-12
Humeral Spacer, 39+15 mm	AR-9505-15
Humeral Spacer, 42+6 mm	AR-9550-06
Humeral Spacer, 42+9 mm	AR-9550-09
Humeral Spacer, 42+12 mm	AR-9550-12
Humeral Spacer, 42+15 mm	AR-9550-15
Humeral Spacer, 36+6 mm	AR-9555-06
Humeral Spacer, 36+9 mm	AR-9555-09
Humeral Spacer, 36+12 mm	AR-9555-12
Humeral Spacer, 36+15 mm	AR-9555-15
Combination Humeral Inserts	
Combination Humeral Insert, 33+3/36	AR-9503-3336-3
Combination Humeral Insert, 33+6/36	AR-9503-3336-6
Combination Humeral Insert, 33+3C/36, constrained	AR-9503-3336-3C
Combination Humeral Insert, 33+6C/36, constrained	AR-9503-3336-6C
Combination Humeral Insert, 36+3/33	AR-9503-3633-3
Combination Humeral Insert, 36+6/33	AR-9503-3633-6
Combination Humeral Insert, 36+3/33, constrained	AR-9503-3633-3C
Combination Humeral Insert, 36+6/33, constrained	AR-9503-3633-6C
Combination Humeral Insert, 36+3/39	AR-9503-3639-3
Combination Humeral Insert, 36+6/39	AR-9503-3639-6
Combination Humeral Insert, 36+3/39, constrained	AR-9503-3639-3C
Combination Humeral Insert, 36+6/39, constrained	AR-9503-3639-6C
Combination Humeral Insert, 39+3/42	AR-9503-3942-3
Combination Humeral Insert, 39+6/42	AR-9503-3942-6
Combination Humeral Insert, 39+3/42, constrained	AR-9503-3942-3C
Combination Humeral Insert, 39+6/42, constrained	AR-9503-3942-6C
Combination Humeral Insert, 42+3/45	AR-9503-4245-3
Combination Humeral Insert, 42+6/45	AR-9503-4245-6
Combination Humeral Insert, 42+3/45, constrained	AR-9503-4245-3C
Combination Humeral Insert, 42+6/45, constrained	AR-9503-4245-6C

Univers Revers™ Apex Humeral Instrumentation Set

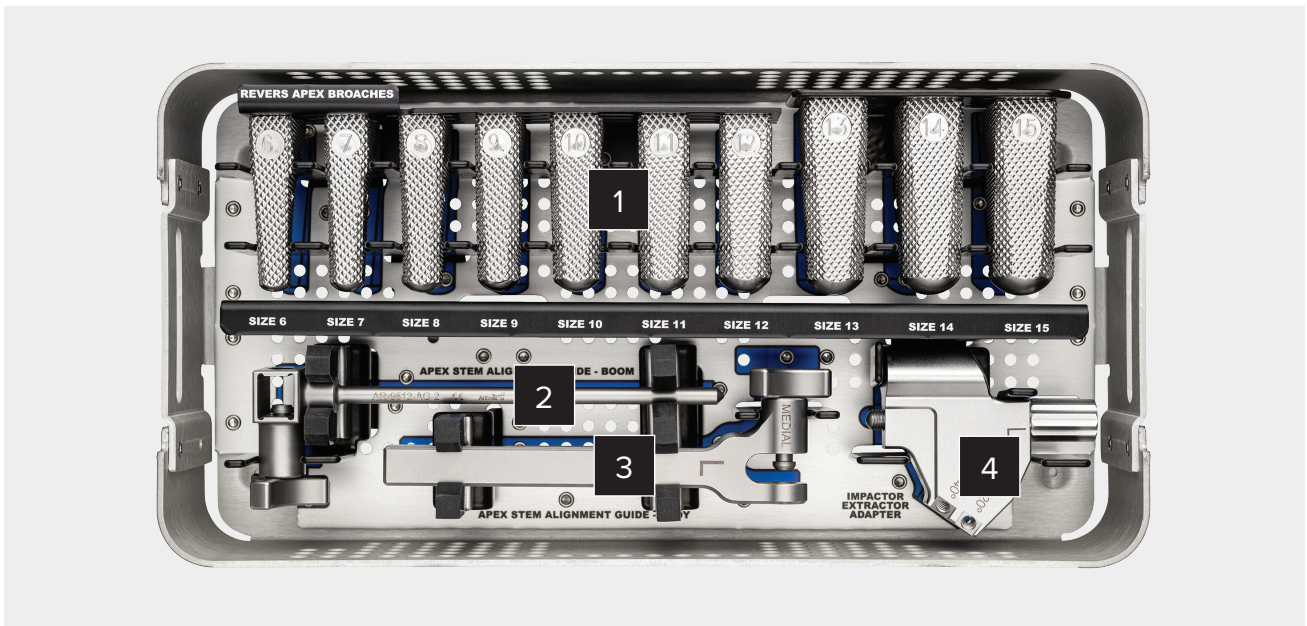

Univers Revers Apex Humeral Instrumentation Set (AR-9501-RAB)

Label	Product Description	Item Number
1	Revers Apex Broach/Trial, size 6	AR-9510-06SM
	Revers Apex Broach/Trial, size 7	AR-9510-07SM
	Revers Apex Broach/Trial, size 8	AR-9510-08SM
	Revers Apex Broach/Trial, size 9	AR-9510-09SM
	Revers Apex Broach/Trial, size 10	AR-9510-10SM
	Revers Apex Broach/Trial, size 11	AR-9510-11SM
	Revers Apex Broach/Trial, size 12	AR-9510-12SM
	Revers Apex Broach/Trial, size 13	AR-9510-13SM
	Revers Apex Broach/Trial, size 14	AR-9510-14SM
	Revers Apex Broach/Trial, size 15	AR-9510-15SM
2	Univers Revers Humeral Alignment Guide Boom	AR-9512-AG-1
3	Univers Revers Humeral Alignment Guide Body	AR-9512-AG-2
4	Univers Revers Apex Impactor/Extractor	AR-9511-2

Uniers Revers™ Humeral Broach Instrumentation Set

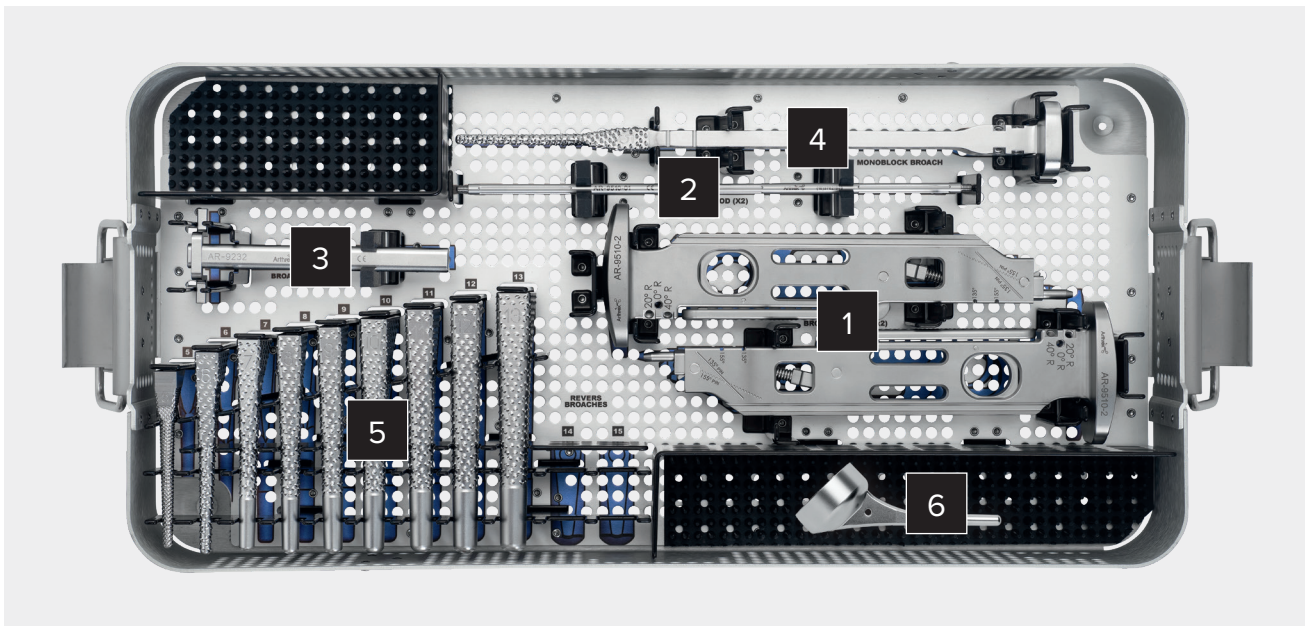

Uniers Revers Humeral Broach Instrumentation Set - Bottom Tray (AR-9501HBS)

Label	Product Description	Item Number
1	Lever-Lock Broach Handle	AR-9510-2
2	Version Rod	AR-9510-01
3	Humeral Broach Alignment Guide	AR-9232
4	Monoblock Broach, size 4/33	AR-9510-04M
5	Revers Humeral Broach, size 5 Revers Humeral Broach, size 6 Revers Humeral Broach, size 7 Revers Humeral Broach, size 8 Revers Humeral Broach, size 9 Revers Humeral Broach, size 10 Revers Humeral Broach, size 11 Revers Humeral Broach, size 12 Revers Humeral Broach, size 13	AR-9510-05MDM AR-9510-06M AR-9510-07M AR-9510-08M AR-9510-09M AR-9510-10M AR-9510-11M AR-9510-12M AR-9510-13M
6	Monoblock Stem Trial, size 4/33	AR-9523-04-135

Univers Revers™ Humeral Instrument Set 1

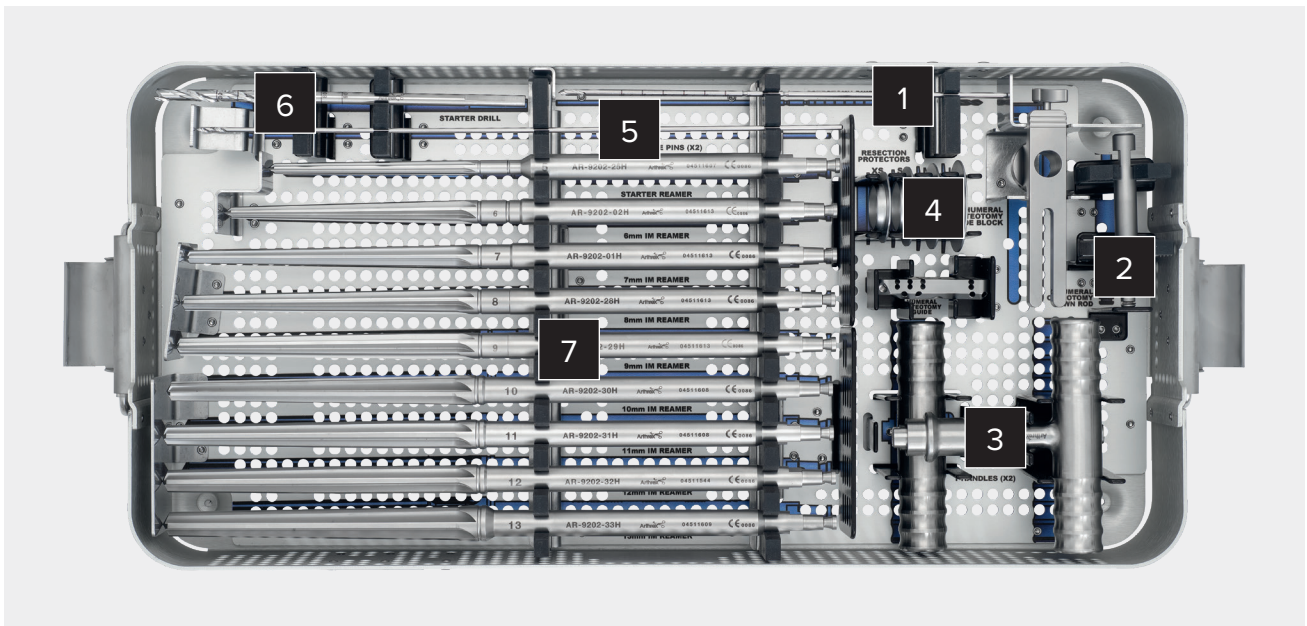

Univers Revers Humeral Instrument Set 1 (AR-9501HS-1)

Label	Product Description	Item Number
1	Osteotomy Guide Pin	AR-13303-2.4
2	Humeral Resection Guide Assembly	AR-9507RGDP
3	Universal T-Handle	AR-9202-15H
4	Humeral Resection Protector, extra small Humeral Resection Protector, small Humeral Resection Protector, medium Humeral Resection Protector, large	AR-9509-XS AR-9509-S AR-9509-M AR-9509-L
5	2.4 mm Guidewires	AR-1250L
6	Cannulated Drill, 6 mm	AR-1206L
7	IM Reamer, 5 mm IM Reamer, 6 mm IM Reamer, 7 mm IM Reamer, 8 mm IM Reamer, 9 mm IM Reamer, 10 mm IM Reamer, 11 mm IM Reamer, 12 mm IM Reamer, 13 mm	AR-9202-25H AR-9202-02H AR-9202-01H AR-9202-28H AR-9202-29H AR-9202-30H AR-9202-31H AR-9202-32H AR-9202-33H

Univers Revers™ Humeral Instrument Set 2

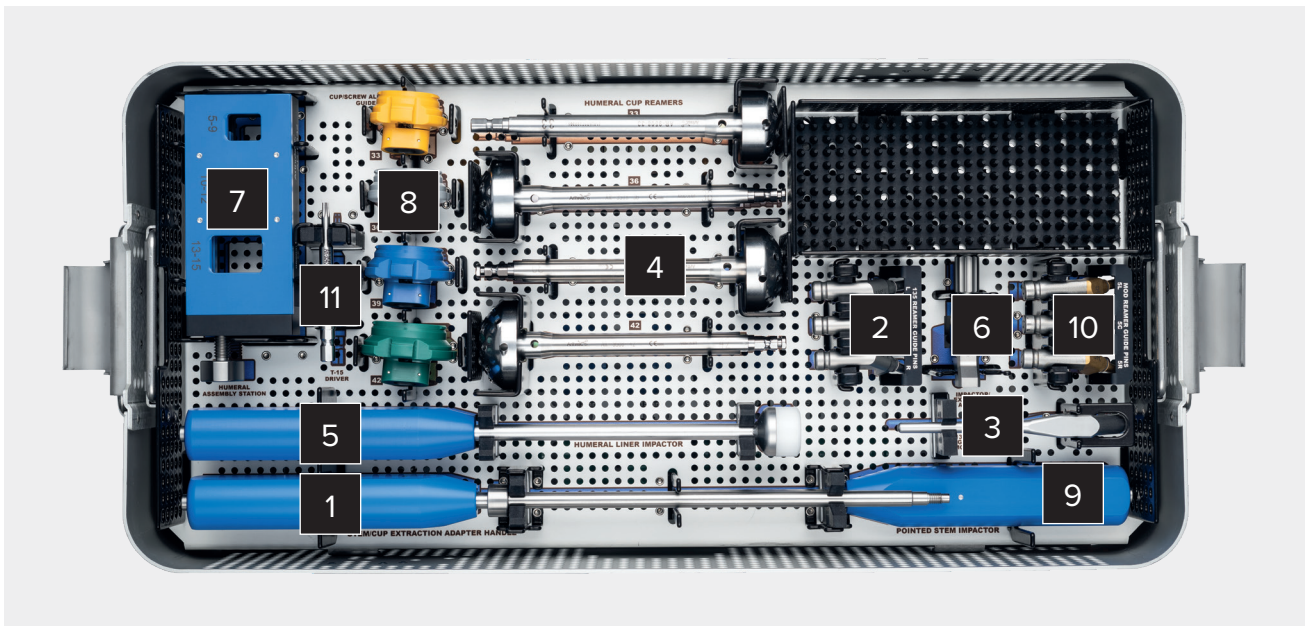

Univers Revers Humeral Instrument Set 2 - Top Tray (AR-9501HS-2)

Label	Product Description	Item Number
1	Stem/Cup Impactor/Extractor Handle	AR-9512
2	Univers Modular Reamer Pins, 135°	AR-9510RG-C/R/L
3	Reamer/Guide, size 4/33, 135°	AR-9510-04-135
4	Humeral Cup Reamer, 33 mm Humeral Cup Reamer, 36 mm Humeral Cup Reamer, 39 mm Humeral Cup Reamer, 42 mm	AR-9508-33 AR-9508-36 AR-9508-39 AR-9508-42
5	Liner/Glenosphere Impactor	AR-9531
6	Humeral Impactor/Extractor Adapter	AR-9511-2
7	Assembly Stand	AR-9532
8	Cup Screw Alignment Guide, 33 mm Cup Screw Alignment Guide, 36 mm Cup Screw Alignment Guide, 39 mm Cup Screw Alignment Guide, 42 mm	AR-9532-33 AR-9532-36 AR-9532-39 AR-9532-42
9	Pointed Impactor	AR-9202-09
10	Univers Revers Reamer Guides, size 5	AR-9510RG-5C/5R/5L
11	T15 Driver Shaft, short	AR-9545-T15-01

Univers Revers™ Humeral Instrument Set 2 (Cont.)

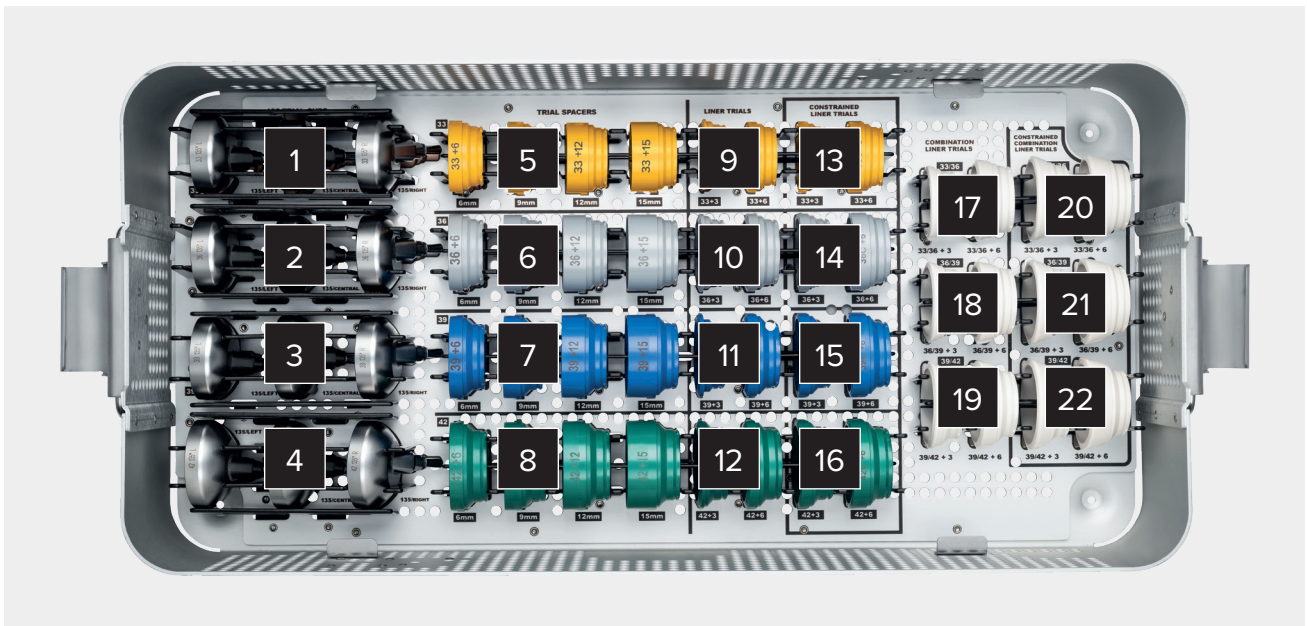

Univers Revers Humeral Instrument Set 2 - Bottom Tray (AR-9501HS-2)

Label	Product Description	Item Number
1	135° Trial Cups, 33 mm	AR-9523-135/135R/135L
2	135° Trial Cups, 36 mm	AR-9522-135/135R/135L
3	135° Trial Cups, 39 mm	AR-9520-135/135R/135L
4	135° Trial Cups, 42 mm	AR-9521-135/135R/135L
5	Trial Spacers, 33 mm	AR-9554-06/09/12/15
6	Trial Spacers, 36 mm	AR-9551-06/09/12/15
7	Trial Spacers, 39 mm	AR-9552-06/09/12/15
8	Trial Spacers, 42 mm	AR-9553-06/09/12/15
9	Trial Liners, 33 mm	AR-9530XS-03/06
10	Trial Liners, 36 mm	AR-9530S-03/06
11	Trial Liners, 39 mm	AR-9530M-03/06
12	Trial Liners, 42 mm	AR-9530L-03/06
13	Constrained Trial Liners, 33 mm	AR-9530XS-03C/06C
14	Constrained Trial Liners, 36 mm	AR-9530S-03C/06C
15	Constrained Trial Liners, 39 mm	AR-9530M-03C/06C
16	Constrained Trial Liners, 42 mm	AR-9530L-03C/06C
17	Combo Trial Liners, 33 mm/36 mm	AR-9603-3336-3/6
18	Combo Trial Liners, 36 mm/39 mm	AR-9603-3639-3/6
19	Combo Trial Liners, 39 mm/42 mm	AR-9603-3942-3/6
20	Constrained Combo Trial Liners, 33 mm/36 mm	AR-9603-3336-3C/6C
21	Constrained Combo Trial Liners, 36 mm/39 mm	AR-9603-3639-3C/6C
22	Constrained Combo Trial Liners, 39 mm/42 mm	AR-9603-3942-3C/6C

Univers Revers™ CA Head and Adapter Trials

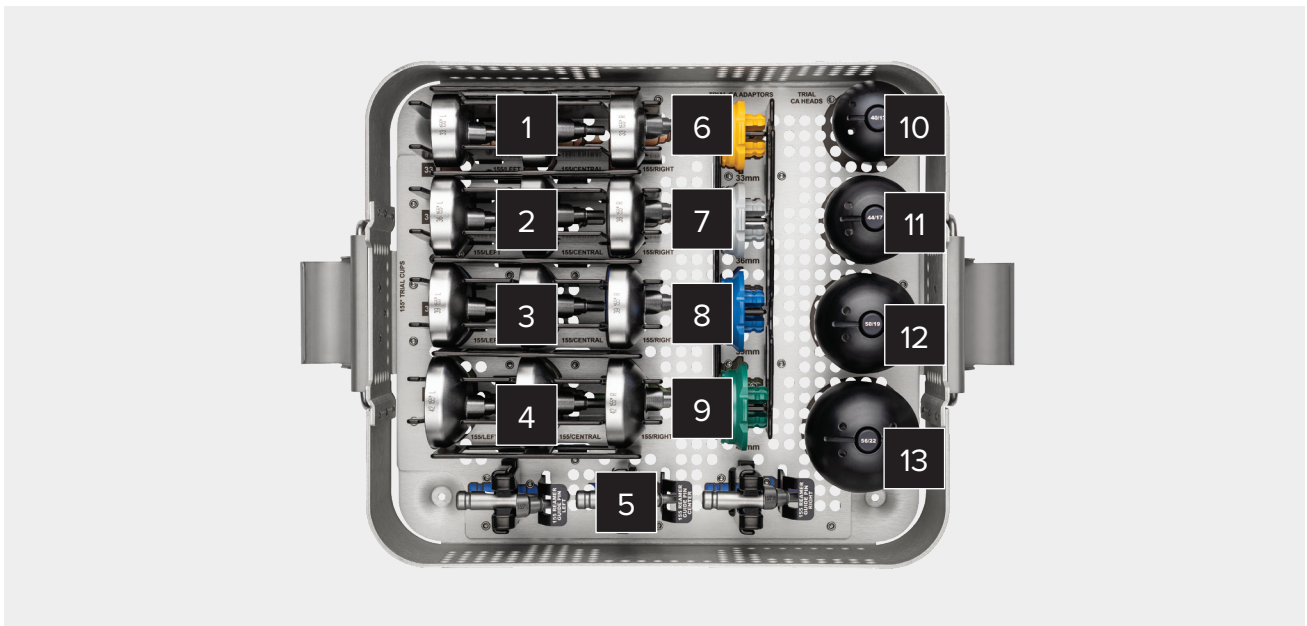

Univers Revers CA Head and Adapter Trials (AR-9501H-CA155S)

Label	Product Description	Item Number
1	155° Trial Cups, 33 mm	AR-9523-155/155R/155L
2	155° Trial Cups, 36 mm	AR-9522-155/155R/155L
3	155° Trial Cups, 39 mm	AR-9520-155/155R/155L
4	155° Trial Cups, 42 mm	AR-9521-155/155R/155L
5	Univers Modular Reamer Pins, 155°	AR-9511RG-C/R/L
6	Univers Revers CA Trial Adapter, 33 mm	AR-9522-33ARCAT
7	Univers Revers CA Trial Adapter, 36 mm	AR-9522-36ARCAT
8	Univers Revers CA Trial Adapter, 39 mm	AR-9522-39ARCAT
9	Univers Revers CA Trial Adapter, 42 mm	AR-9522-42ARCAT
10	Univers Revers CA Trial Head, 40/17 mm	AR-9540-17RCAT
11	Univers Revers CA Trial Head, 44/17 mm	AR-9544-17RCAT
12	Univers Revers CA Trial Head, 50/19 mm	AR-9550-19RCAT
13	Univers Revers CA Trial Head, 56/22 mm	AR-9556-22RCAT

Univers Revers™ CA Head and Adapter Trials (Cont.)

Disposables

Product Description	Item Number
Univers Revers Sterile Pin Set	AR-9507S

Optional Instruments

Product Description	Item Number
Humeral Resection Block, 135°/155° (superolateral)	AR-9507RGSL-1
Superolateral Version Guide Adapter	AR-9507RGSL-2
Univers Revers Reduction Tool	AR-9545
Superolateral Humeral Resection Instrument Set	AR-9507RGSL
Humeral Resection Block, 135°/155° (superolateral)	AR-9507RGSL-1
Superolateral Version Guide Adapter	AR-9507RGSL-2
Superolateral Version Downrod	AR-9507RGSL-3
Univers Revers Reduction Tool	AR-9545
Large Humeral (14/15 mm) Instrument Set	AR-9501LHS
IM Reamer, 14 mm	AR-9202-34H
IM Reamer, 15 mm	AR-9202-35H
Broach/Trial, 14 mm	AR-9510-14
Broach/Trial, 15 mm	AR-9510-15

Product Description	Item Number
Revision Humeral Instrument Set	AR-9501RHS
IM Reamer, 6 mm, revision	AR-9506-06R
IM Reamer, 9 mm, revision	AR-9506-09R
IM Reamer, 12 mm, revision	AR-9506-12R
Broach/Trial, 6 mm, revision	AR-9510-06R
Broach/Trial, 9 mm, revision	AR-9510-09R
Broach/Trial, 12 mm, revision	AR-9510-12R

Univers Revers™ Modular Glenoid System



Baseplates

- 24 mm and 28 mm diameters
- 0 mm, +2 mm, +4 mm lateral augmentation options
- BioSync® matrix with interconnected porosity for ingrowth³
- 4 peripheral screw holes accommodate accommodate both 5.5 mm locking and 4.5 mm nonlocking screws



Univers Revers™ Modular Glenoid System (Cont.)

Central Fixation

- Hybrid central screw for compression and ingrowth
- Central post for press-fit and ingrowth
- Numerous lengths to address various glenoid vault depths (15 mm to 35 mm)
- BioSync® matrix with interconnected porosity for ingrowth³



Glenospheres

- 33 mm, 36 mm, 39 mm, 42 mm, and 45 mm diameters
- +0 mm, +4 mm lateralized, and +2.5 mm eccentric offset options
- Titanium options available for patients with cobalt alloy intolerance



Uniers Revers™ Modular Glenoid System (Cont.)

Implants

Product Description	Item Number
Glenoid Baseplates	
Baseplate, monoblock screw, 24 mm	AR-9560-24S
Baseplate, monoblock post, 24 mm	AR-9560-24P
Baseplate, modular, 24 mm	AR-9560-24
Lateralized baseplate, modular, 24 mm+2	AR-9560-24-2
Lateralized baseplate, modular, 24 mm+4	AR-9560-24-4
Baseplate, modular, 28 mm	AR-9560-28
Lateralized baseplate, modular, 28 mm+2	AR-9560-28-2
Lateralized baseplate, modular, 28 mm+4	AR-9560-28-4
Modular Central Fixation	
Modular Central Screw, 20 mm	AR-9561-20S
Modular Central Screw, 25 mm	AR-9561-25S
Modular Central Screw, 30 mm	AR-9561-30S
Modular Central Screw, 35 mm	AR-9561-35S
Modular Central Post, 20 mm	AR-9561-20P
Modular Central Post, 25 mm	AR-9561-25P
Modular Central Post, 30 mm	AR-9561-30P
Modular Central Post, 35 mm	AR-9561-35P
4.5 mm Nonlocking Peripheral Bone Screws	
Nonlocking Screws, 4.5 mm × 16 mm-48, 16 mm	AR-9562-16NL
Nonlocking Screws, 4.5 mm × 16 mm-48, 20 mm	AR-9562-20NL
Nonlocking Screws, 4.5 mm × 16 mm-48, 24 mm	AR-9562-24NL
Nonlocking Screws, 4.5 mm × 16 mm-48, 28 mm	AR-9562-28NL
Nonlocking Screws, 4.5 mm × 16 mm-48, 32 mm	AR-9562-32NL
Nonlocking Screws, 4.5 mm × 16 mm-48, 36 mm	AR-9562-36NL
Nonlocking Screws, 4.5 mm × 16 mm-48, 40 mm	AR-9562-40NL
Nonlocking Screws, 4.5 mm × 16 mm-48, 44 mm	AR-9562-44NL
Nonlocking Screws, 4.5 mm × 16 mm-48, 48 mm	AR-9562-48NL
5.5 mm Locking Peripheral Bone Screws	
Locking Screws, 5.5 mm × 16 mm-48 mm, 16 mm	AR-9563-16
Locking Screws, 5.5 mm × 16 mm-48 mm, 20 mm	AR-9563-20
Locking Screws, 5.5 mm × 16 mm-48 mm, 24 mm	AR-9563-24
Locking Screws, 5.5 mm × 16 mm-48 mm, 28 mm	AR-9563-28
Locking Screws, 5.5 mm × 16 mm-48 mm, 32 mm	AR-9563-32
Locking Screws, 5.5 mm × 16 mm-48 mm, 36 mm	AR-9563-36
Locking Screws, 5.5 mm × 16 mm-48 mm, 40 mm	AR-9563-40
Locking Screws, 5.5 mm × 16 mm-48 mm, 44 mm	AR-9563-44
Locking Screws, 5.5 mm × 16 mm-48 mm, 48 mm	AR-9563-48
CoCr Glenospheres	
Glenosphere, 33/24	AR-9564-2433
Glenosphere, 33+4 LAT/24	AR-9564-2433-LAT
Glenosphere, 36/24	AR-9564-2436
Glenosphere, 36+4 LAT/24	AR-9564-2436-LAT
Glenosphere, 36+2.5 INF/24	AR-9564-2436-INF
Glenosphere, 39/24	AR-9564-2439
Glenosphere, 39+4 LAT/24	AR-9564-2439-LAT
Glenosphere, 39+2.5 INF/24	AR-9564-2439-INF

Product Description	Item Number
CoCr Glenospheres	
Glenosphere, 42/24	AR-9564-2442
Glenosphere, 42+4 LAT/24	AR-9564-2442-LAT
Glenosphere, 42+2.5 INF/24	AR-9564-2442-INF
Glenosphere, 45/24	AR-9564-2445
Glenosphere, 45+2.5 INF/24	AR-9564-2445-INF
Glenosphere, 45+4 LAT/24	AR-9564-2445-LAT
Glenosphere, 36/28	AR-9564-2836
Glenosphere, 36+4, LAT/28	AR-9564-2836-LAT
Glenosphere, 39/28	AR-9564-2839
Glenosphere, 39+4 LAT/28	AR-9564-2839-LAT
Glenosphere, 39+2.5 INF/28	AR-9564-2839-INF
Glenosphere, 42/28	AR-9564-2842
Glenosphere, 42 LAT/28	AR-9564-2842-LAT
Glenosphere, 42+2.5 INF/28	AR-9564-2842-INF
Glenosphere, 45/28	AR-9564-2845
Glenosphere, 45+2.5 INF/28	AR-9564-2845-INF
Glenosphere, 45+4 LAT/28	AR-9564-2845-LAT
Titanium Glenospheres	
33/24 Ti Glenosphere	AR-9564-T2433
33+4 LAT/24 Ti Glenosphere	AR-9564-T2433-LAT
36/24 Ti Glenosphere	AR-9564-T2436
36+4 LAT/24 Ti Glenosphere	AR-9564-T2436-LAT
36+2.5 INF/24 Ti Glenosphere	AR-9564-T2436-INF
39/24 Ti Glenosphere	AR-9564-T2439
39+4 LAT/24 Ti Glenosphere	AR-9564-T2439-LAT
39+2.5 INF/24 Ti Glenosphere	AR-9564-T2439-INF
42/24 Ti Glenosphere	AR-9564-T2442
42+4 LAT/24 Ti Glenosphere	AR-9564-T2442-LAT
42+2.5 INF/24 Ti Glenosphere	AR-9564-T2442-INF

Disposables

Product Description	Item Number
Glenosphere Screw, extra	AR-9565
MGS Sterile Pin Kit	AR-9607S
3.0 MGS Sterile Drill Bit	AR-9628S

Modular Glenoid System, Instrument Set 1

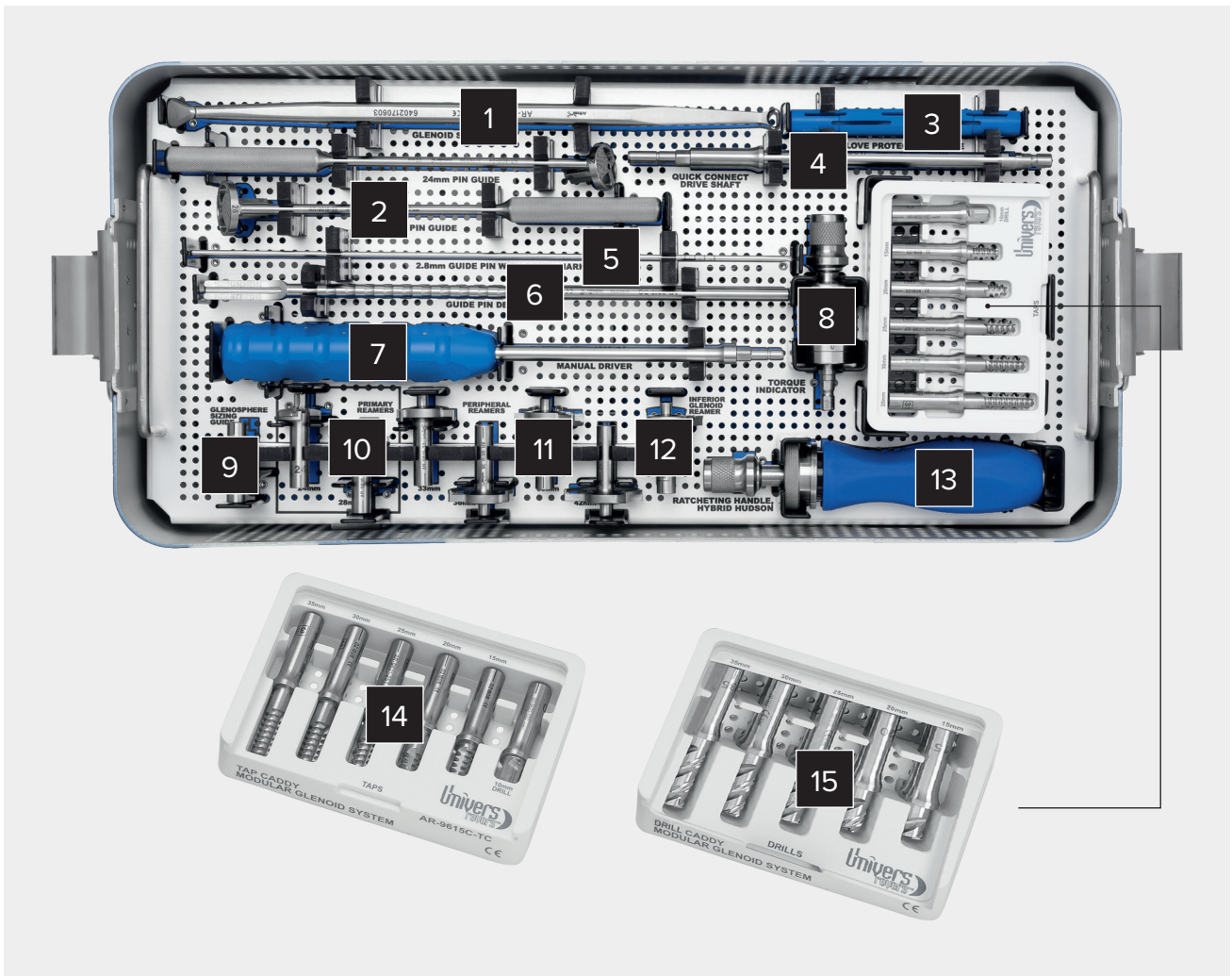

Modular Glenoid System, Instrument Set 1 - Top Tray (AR-9615C-1)

Label	Product Description	Item Number
1	Glenoid Scrapette	AR-9601
2	Pin Guide, 24 mm Pin Guide, 28 mm	AR-9616-24 AR-9616-28
3	Glove Protector Sleeve, qty. 2	AR-9216-4
4	Modular Reamer Shaft, qty. 2	AR-9617
5	Guide Pin, 2.8 mm, qty. 2	AR-9616
6	Guide Pin Depth Gauge	AR-9616-DG
7	Manual Driver Shaft	AR-9631
8	Torque-Indicating Adapter	AR-9545-T15H
9	Glenosphere Sizing Guide	AR-9664-SG
10	Primary Glenoid Reamer, 24 mm Primary Glenoid Reamer, 28 mm	AR-9618-24 AR-9618-28
11	Peripheral Reamer, 33 mm Peripheral Reamer, 36 mm Peripheral Reamer, 39 mm Peripheral Reamer, 42 mm	AR-9619-33 AR-9619-36 AR-9619-39 AR-9619-42

Label	Product Description	Item Number
12	Inferior Glenoid Reamer	AR-9632-INF
13	Ratcheting Handle, hybrid Hudson	AR-1999HH
14	Tap Caddy Drill, 10 mm Tap, 15 mm Tap, 20 mm Tap, 25 mm Tap, 30 mm Tap, 35 mm	AR-9615C-TC AR-9620-10D AR-9621-15T AR-9621-20T AR-9621-25T AR-9621-30T AR-9621-35T
15	Drill Caddy Drill, 15 mm Drill, 20 mm Drill, 25 mm Drill, 30 mm Drill, 35 mm	AR-9615C-DC AR-9620-15D AR-9620-20D AR-9620-25D AR-9620-30D AR-9620-35D

Modular Glenoid System, Instrument Set 1 (Cont.)

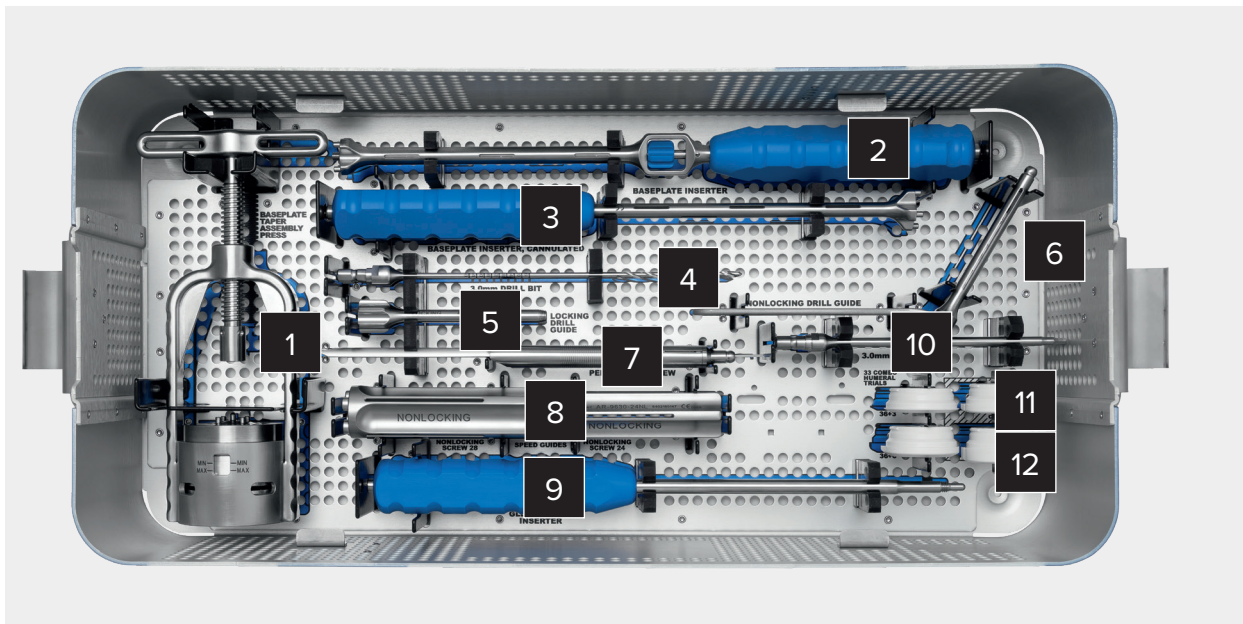

Modular Glenoid System, Instrument Set 1 - Bottom Tray (AR-9615C-1)

Label	Product Description	Item Number
1	Taper Assembly Press	AR-9622
2	Baseplate Inserter, threaded	AR-9623
3	Baseplate Inserter, cannulated	AR-9623-C
4	Drill, 3 mm, qty. 2	AR-9628
5	Drill Guide, locking screw	AR-9626
6	Drill Guide, nonlocking screw	AR-9627
7	Peripheral Screw Depth Gauge	AR-9629
8	Speed Guide for 24 mm Baseplate Speed Guide for 28 mm Baseplate	AR-9630-24NL AR-9630-28NL
9	Glenosphere Inserter	AR-9624
10	Driver, Hex, 3 mm, qty. 2	AR-9625
11	Combination Humeral Trial, 36+3/33 Combination Humeral Trial, 36+6/33	AR-9603-3633-3 AR-9603-3633-6
12	Constrained Combination Humeral Trial, 36+3/33 Constrained Combination Humeral Trial, 36+6/33	AR-9603-3633-3C AR-9603-3633-6C

Modular Glenoid System, Instrument Set 2

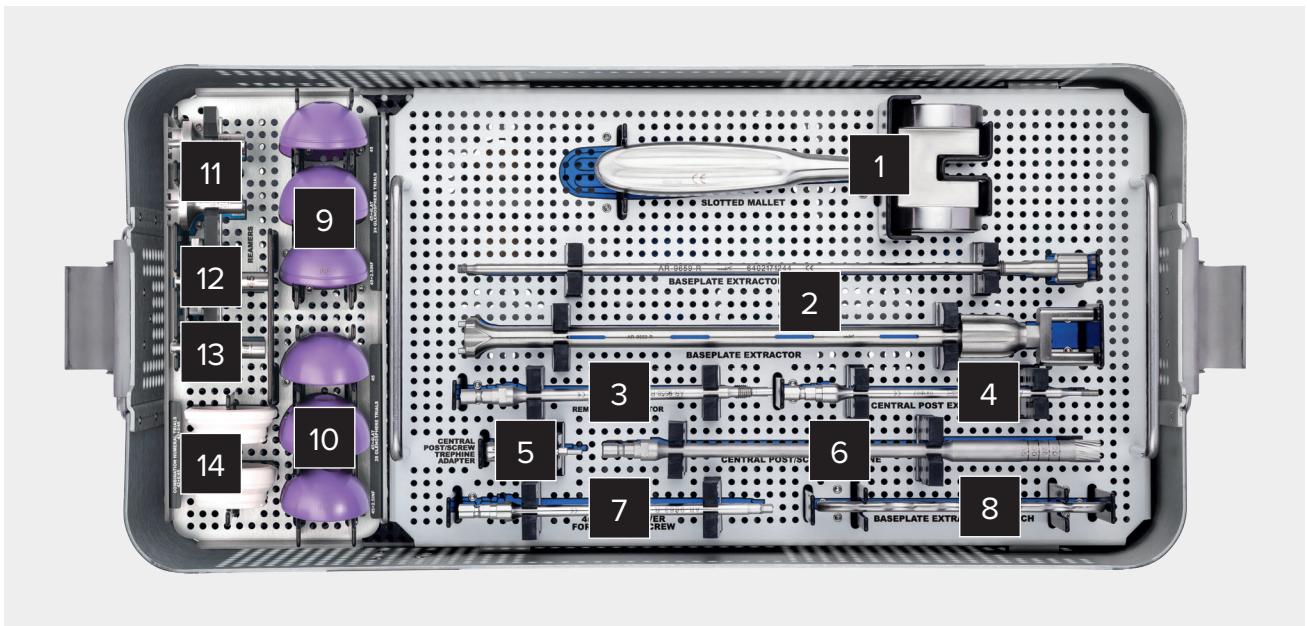

Modular Glenoid System, Instrument Set 2 - Top Tray (AR-9615C-2)

Label	Product Description	Item Number
1	Mallet, slotted	AR-9231-21
2	Baseplate Extractor and Extractor Shaft	AR-9659-R
3	Glenosphere Distractor	AR-9658-R
4	Central Post Extractor	AR-9660-R
5	Central Post/Screw Trephine Adapter	AR-9661-R
6	Central Post/Screw Trephine	AR-9662-R
7	Driver for Central Screw, 4 mm	AR-9663-R
8	Baseplate Extractor Wrench	AR-9659-RW

Optional: MGS Size 45 Instrument Set (AR-9615-45S)

Label	Product Description	Item Number
9	Trial Glenosphere, 45/24 Trial Glenosphere, 45+2.5 INF/24 Trial Glenosphere, 45+4 LAT/24	AR-9664-2445 AR-9664-2445-INF AR-9664-2445-LAT
10	Trial Glenosphere, 45/28 Trial Glenosphere, 45+2.5 INF/28 Trial Glenosphere, 45+4 LAT/28	AR-9664-2845 AR-9664-2845-INF AR-9664-2845-LAT
11	Over Baseplate Reamer, 45/24 Over Baseplate Reamer, 45/28	AR-9632-2445 AR-9632-2845
12	45 mm Peripheral Reamer	AR-9619-45
13	Inferior Glenoid Reamer, 45	AR-9632-45INF
14	Combination Humeral Trial, 42+3/45 Combination Humeral Trial, 42+6/45	AR-9603-4245-3 AR-9603-4245-6

Modular Glenoid System, Instrument Set 2 (Cont.)



Modular Glenoid System, Instrument Set 2 - Bottom Tray (AR-9615C-2)

Label	Product Description	Item Number
1	Trial Glenosphere, 33/24 Trial Glenosphere, 33+4 LAT/24	AR-9664-2433 AR-9664-2433-LAT
2	Trial Glenosphere, 36/24 Trial Glenosphere, 36+2.5 INF/24 Trial Glenosphere, 36+4 LAT/24	AR-9664-2436 AR-9664-2436-INF AR-9664-2436-LAT
3	Trial Glenosphere, 39/24 Trial Glenosphere 39+2.5 INF/24 Trial Glenosphere, 39+4 LAT/24	AR-9664-2439 AR-9664-2439-INF AR-9664-2439-LAT
4	Trial Glenosphere, 42/24 Trial Glenosphere, 42+2.5 INF/24 Trial Glenosphere, 42+4 LAT/24	AR-9664-2442 AR-9664-2442-INF AR-9664-2442-LAT
5	Trial Glenosphere, 36/28 Trial Glenosphere, 36+4 LAT/28	AR-9664-2836 AR-9664-2836-LAT
6	Trial Glenosphere, 39/28 Trial Glenosphere, 39+2.5 INF/28 Trial Glenosphere, 39+4 LAT/28	AR-9664-2839 AR-9664-2839-INF AR-9664-2839-LAT
7	Trial Glenosphere, 42/28 Trial Glenosphere, 42+2.5 INF/28 Trial Glenosphere, 42+4 LAT/28	AR-9664-2842 AR-9664-2842-INF AR-9664-2842-LAT
8	Over Baseplate Reamer, 36/24 Over Baseplate Reamer, 39/24 Over Baseplate Reamer, 42/24 Over Baseplate Reamer, 36/28 Over Baseplate Reamer, 39/28 Over Baseplate Reamer, 42/28	AR-9632-2436 AR-9632-2439 AR-9632-2442 AR-9632-2836 AR-9632-2839 AR-9632-2842

Bone Graft Preparation for the Uniers Revers™ Modular Glenoid System (AR-9665S)

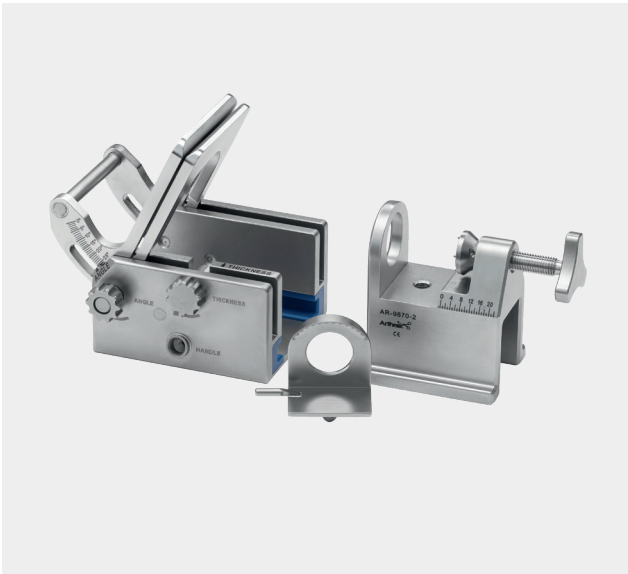

Technique Precision in Harvesting, Shaping, and Preparing Bony Augments

- Humeral sizing instruments available in both 135° and 155°
- Glenoid defect gauge to determine the angle/ thickness of the graft required
- Adjustable variable drill for precision in central vault drilling length

Disposables

Product Description	Item Number
Angled Reamer, small	AR-9675-S
Angled Reamer, medium	AR-9675-M
Angled Reamer, large	AR-9675-L
Angled Reamer, extra large	AR-9675-XL

Bone Graft Instrument Set

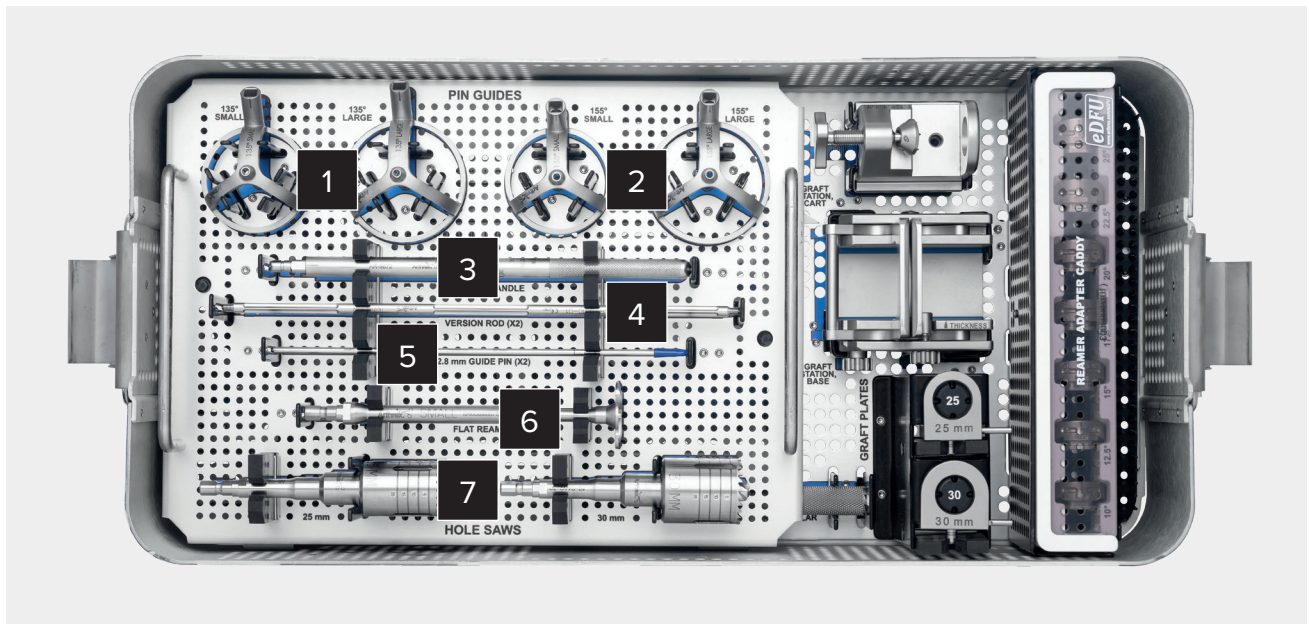

Bone Graft Instrument Set - Top Tray (AR-9665S)

Label	Product Description	Item Number
1	Pin Guide, 135°, 2.8 mm, small	AR-9672-135S
	Pin Guide, 135°, 2.8 mm, large	AR-9672-135L
2	Pin Guide, 155°, 2.8 mm, small	AR-9672-155S
	Pin Guide, 155°, 2.8 mm, large	AR-9672-155L
3	Pin Guide, handle, 2.8 mm	AR-9672
4	Uniers Revers Version Rod	AR-9510-01
5	Guide Pin, 2.8 mm	AR-9165K
6	Uniers Revers Flat Reamer, cannulated, 33 mm diameter, small	AR-9128RF-01
7	Hole Saw, cannulated, $\varnothing 25$ mm, w/ $\varnothing 9.5$ mm, central bit	AR-9669-25
	Hole Saw, cannulated, $\varnothing 30$ mm, w/ $\varnothing 9.5$ mm, central bit	AR-9669-30

Bone Graft Instrument Set (Cont.)

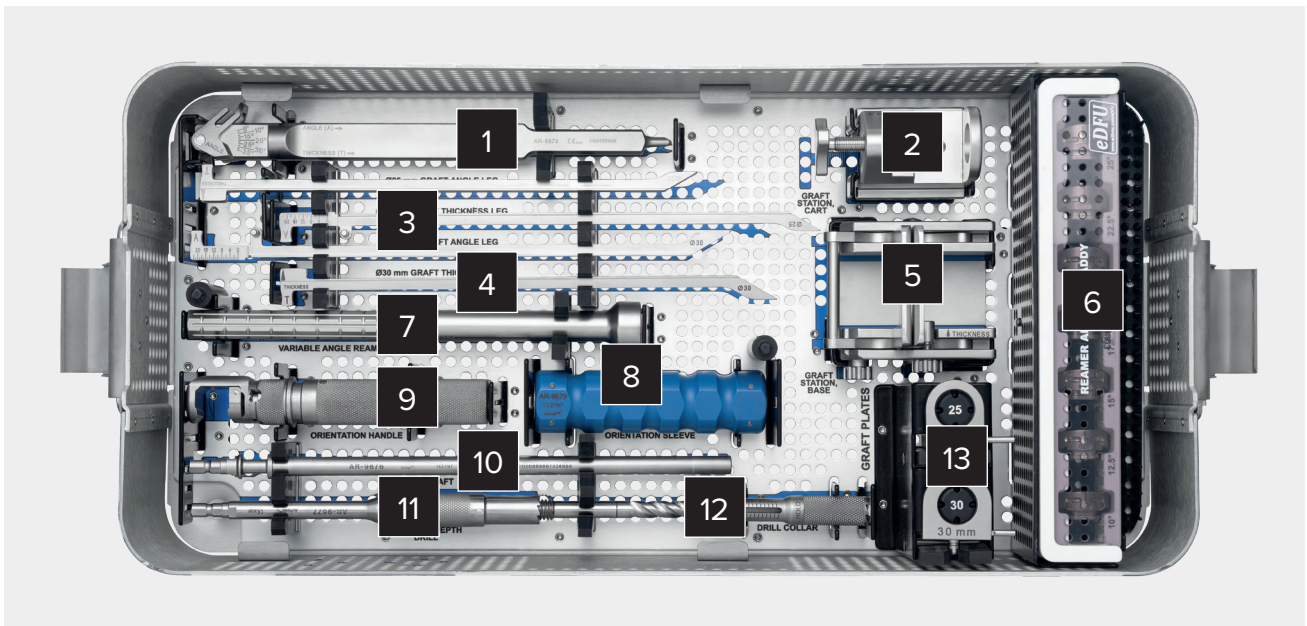

Bone Graft Instrument Set - Bottom Tray (AR-9665S)

Label	Product Description	Item Number
1	Glenoid Defect Gauge, housing	AR-9673
2	Graft Preparation Station, cart	AR-9670-2
3	Glenoid Defect Gauge, $\varnothing 25$ mm graft angle leg Glenoid Defect Gauge, $\varnothing 25$ mm graft thickness leg	AR-9673-25A AR-9673-25T
4	Glenoid Defect Gauge, $\varnothing 30$ mm graft angle leg Glenoid Defect Gauge, $\varnothing 30$ mm graft thickness leg	AR-9673-30A AR-9673-30T
5	Graft Preparation Station, base	AR-9670-1
6	Reamer Adapter, 10° Reamer Adapter, 12.5° Reamer Adapter, 15° Reamer Adapter, 17.5° Reamer Adapter, 20° Reamer Adapter, 22.5° Reamer Adapter, 25°	AR-9674-10 AR-9674-125 AR-9674-15 AR-9674-175 AR-9674-20 AR-9674-225 AR-9674-25
7	Modular Reamer Sleeve	AR-9674
8	Angled Reamer, orientation sleeve	AR-9679
9	Angled Reamer, orientation handle	AR-9678
10	Angled Reamer, drive shaft	AR-9676
11	Variable Depth Central Post Drill, shaft	AR-9677
12	Variable Depth Central Post Drill, adjustment collar	AR-9677-1
13	Graft Preparation Raise Plate, $\varnothing 25$ mm graft Graft Preparation Raise Plate, $\varnothing 30$ mm graft	AR-9670-3 AR-9670-4

Univers Revers™ Augmented Modular Glenoid System



Baseplates

- 10° and 20° full-wedge
- 15°, 25°, and 35° half-wedge
- 24 mm and 28 mm diameters
- Available with 2 mm of additional lateral offset
- Standard or oblique augment orientation
- BioSync® matrix with interconnected porosity for ingrowth³
- 4 peripheral screw holes accommodate both 5.5 mm locking and 4.5 mm nonlocking screws

Central Fixation

- Central post for press-fit and ingrowth
- Numerous lengths to address various glenoid vault depths (20 mm to 40 mm)
- BioSync matrix with interconnected porosity for ingrowth³

Glenospheres

- Compatible with all MGS glenospheres

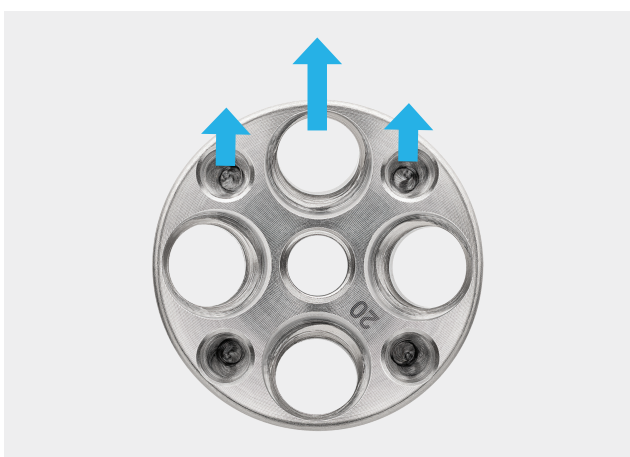

Standard augment orientation

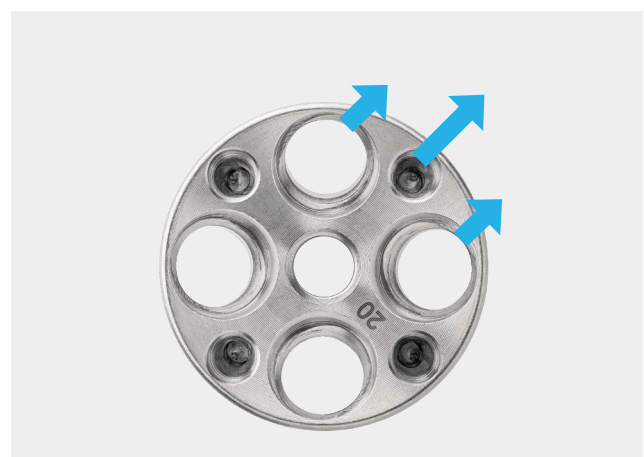

Oblique augment orientation

Univers Revers™ Augmented Modular Glenoid System (Cont.)

Implants

Product Description	Item Number
Full-Wedge	
24 mm Baseplate, 10° full-wedge, oblique	AR-9580-2410
24 mm Baseplate, 20° full-wedge, oblique	AR-9580-2420
24 mm Baseplate, 10° full-wedge, +2 lateralized, oblique	AR-9580-2410-2
24 mm Baseplate, 20° full-wedge, +2 lateralized, oblique	AR-9580-2420-2
24 mm Baseplate, 10° full-wedge	AR-9580-2410S
24 mm Baseplate, 20° full-wedge	AR-9580-2420S
24 mm Baseplate, 10° full-wedge, +2 lateralized	AR-9580-2410-2S
24 mm Baseplate, 20° full-wedge, +2 lateralized	AR-9580-2420-2S
28 mm Baseplate, 10° full-wedge, oblique	AR-9580-2810
28 mm Baseplate, 20° full-wedge, oblique	AR-9580-2820
28 mm Baseplate, 10° full-wedge, +2 lateralized, oblique	AR-9580-2810-2
28 mm Baseplate, 20° full-wedge, +2 lateralized, oblique	AR-9580-2820-2
28 mm Baseplate, 10° full-wedge	AR-9580-2810S
28 mm Baseplate, 20° full-wedge	AR-9580-2820S
28 mm Baseplate, 10° full-wedge, +2 lateralized	AR-9580-2810-2S
28 mm Baseplate, 20° full-wedge, +2 lateralized	AR-9580-2820-2S
Half-Wedge	
24 mm Baseplate, 15° half-wedge, oblique	AR-9581-2415
24 mm Baseplate, 25° half-wedge, oblique	AR-9581-2425
24 mm Baseplate, 35° half-wedge, oblique	AR-9581-2435
24 mm Baseplate, 15° half-wedge, +2 lateralized, oblique	AR-9581-2415-2
24 mm Baseplate, 25° half-wedge, +2 lateralized, oblique	AR-9581-2425-2
24 mm Baseplate, 35° half-wedge, +2 lateralized, oblique	AR-9581-2435-2
24 mm Baseplate, 15° half-wedge	AR-9581-2415S
24 mm Baseplate, 25° half-wedge	AR-9581-2425S
24 mm Baseplate, 35° half-wedge	AR-9581-2435S
24 mm Baseplate, 15° half-wedge, +2 lateralized	AR-9581-2415-2S
24 mm Baseplate, 25° half-wedge, +2 lateralized	AR-9581-2425-2S
24 mm Baseplate, 35° half-wedge, +2 lateralized	AR-9581-2435-2S
28 mm Baseplate, 15° half-wedge, oblique	AR-9581-2815
28 mm Baseplate, 25° half-wedge, oblique	AR-9581-2825
28 mm Baseplate, 35° half-wedge, oblique	AR-9581-2835
28 mm Baseplate, 15° half-wedge, +2 lateralized, oblique	AR-9581-2815-2
28 mm Baseplate, 25° half-wedge, +2 lateralized, oblique	AR-9581-2825-2
28 mm Baseplate, 35° half-wedge, +2 lateralized, oblique	AR-9581-2835-2
28 mm Baseplate, 15° half-wedge	AR-9581-2815S
28 mm Baseplate, 25° half-wedge	AR-9581-2825S
28 mm Baseplate, 35° half-wedge	AR-9581-2835S
28 mm Baseplate, 15° half-wedge, +2 lateralized	AR-9581-2815-2S
28 mm Baseplate, 25° half-wedge, +2 lateralized	AR-9581-2825-2S
28 mm Baseplate, 35° half-wedge, +2 lateralized	AR-9581-2835-2S

Product Description	Item Number
Central Posts	
Modular Post, 20 mm	AR-9582-20
Modular Post, 25 mm	AR-9582-25
Modular Post, 30 mm	AR-9582-30
Modular Post, 35 mm	AR-9582-35
Modular Post, 40 mm	AR-9582-40

Disposables

Product Description	Item Number
Angled Reamer, small	AR-9675-S
Angled Reamer, medium	AR-9675-M
Angled Reamer, large	AR-9675-L
Angled Reamer, extra large	AR-9675-XL
3.0 mm Drill	AR-9628S

Augmented Modular Glenoid System Instrument Set

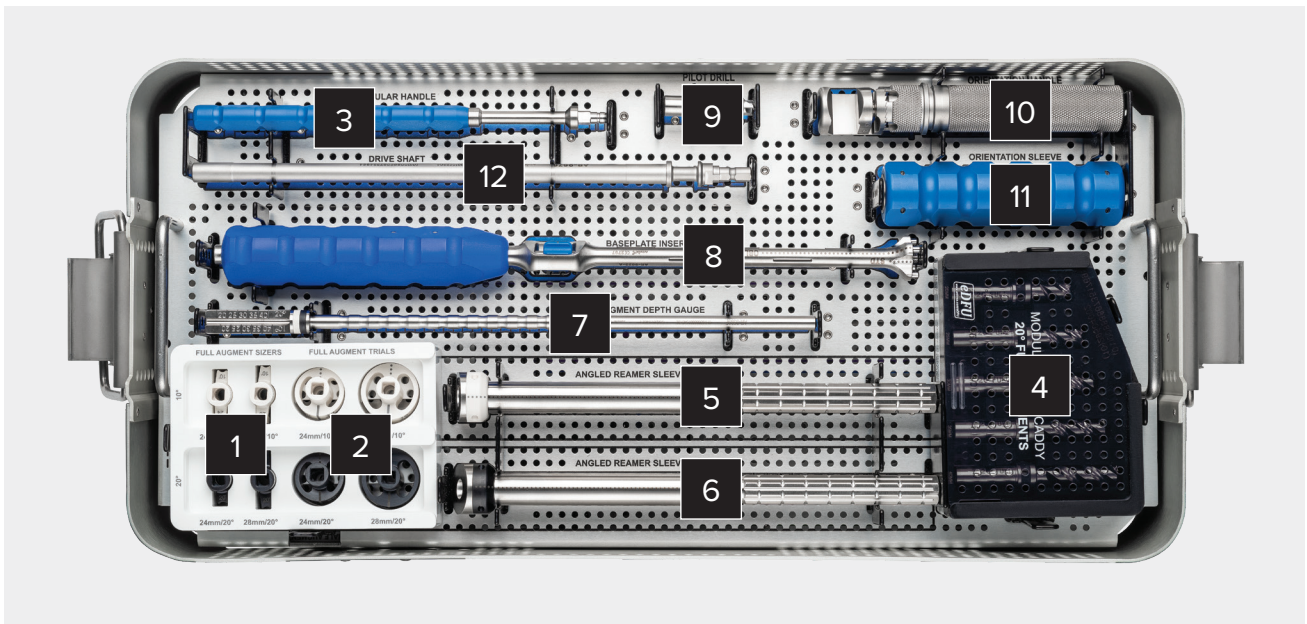

Augmented Modular Glenoid System Instrument Set - Top Tray (AR-9579S)

Label	Product Description	Item Number
1	24 mm Baseplate, 10° full-wedge augment sizer	AR-9592-2410
	24 mm Baseplate, 20° full-wedge augment sizer	AR-9592-2420
	28 mm Baseplate, 10° full-wedge augment sizer	AR-9592-2810
	28 mm Baseplate, 20° full-wedge augment sizer	AR-9592-2820
2	24 mm Baseplate, 10° full-wedge augment trial	AR-9594-2410
	24 mm Baseplate, 20° full-wedge augment trial	AR-9594-2420
	28 mm Baseplate, 10° full-wedge augment trial	AR-9594-2810
	28 mm Baseplate, 20° full-wedge augment trial	AR-9594-2820
3	Modular Handle	AR-9595
4	Modular Drills, 10° full, 20 mm	AR-9596-1020F
	Modular Drills, 10° full, 25 mm	AR-9596-1025F
	Modular Drills, 10° full, 30 mm	AR-9596-1030F
	Modular Drills, 10° full, 35 mm	AR-9596-1035F
	Modular Drills, 10° full, 40 mm	AR-9596-1040F
	Modular Drills, 20° full, 20 mm	AR-9596-2020F
	Modular Drills, 20° full, 25 mm	AR-9596-2025F
	Modular Drills, 20° full, 30 mm	AR-9596-2030F
	Modular Drills, 20° full, 35 mm	AR-9596-2035F
	Modular Drills, 20° full, 40 mm	AR-9596-2040F
5	Angled Reamer Sleeve, 10°	AR-9597-10
6	Angled Reamer Sleeve, 20°	AR-9597-20
7	Full-Wedge Augment Depth Gauge	AR-9599F
8	Baseplate Inserter	AR-9623-A
9	Pilot Drill	AR-9596-P
10	Angled Reamer, orientation handle	AR-9678
11	Angled Reamer, orientation sleeve	AR-9679
12	Angled Reamer, drive shaft	AR-9676

Augmented Modular Glenoid System Instrument Set (Cont.)

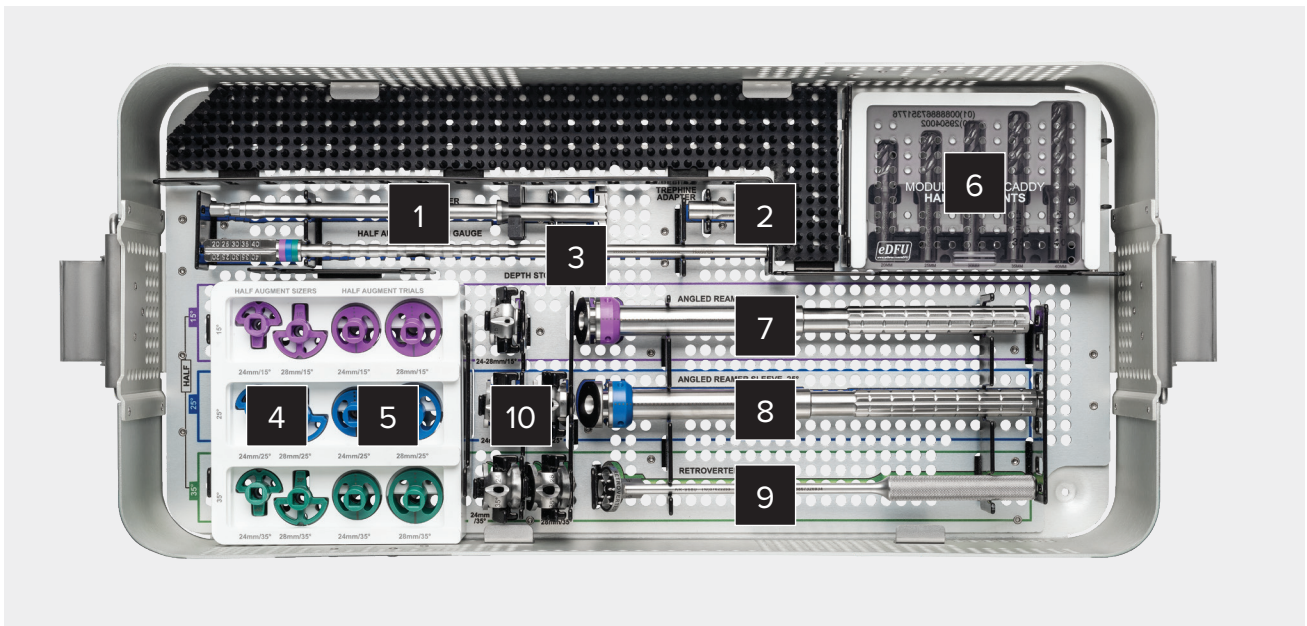

Augmented Modular Glenoid System Instrument Set - Bottom Tray (AR-9579S)

Label	Product Description	Item Number
1	Paleo Reamer	AR-9596
2	Trepine Adapter	AR-9661-A
3	Half-Wedge Depth Gauge	AR-9599H
4	24 mm Baseplate, 15° half-wedge augment sizer 24 mm Baseplate, 25° half-wedge augment sizer 24 mm Baseplate, 35° half-wedge augment sizer 28 mm Baseplate, 15° half-wedge augment sizer 28 mm Baseplate, 25° half-wedge augment sizer 28 mm Baseplate, 35° half-wedge augment sizer	AR-9591-2415 AR-9591-2425 AR-9591-2435 AR-9591-2815 AR-9591-2825 AR-9591-2835
5	24 mm Baseplate, 15° half-wedge augment trial 24 mm Baseplate, 25° half-wedge augment trial 24 mm Baseplate, 35° half-wedge augment trial 28 mm Baseplate, 15° half-wedge augment trial 28 mm Baseplate, 25° half-wedge augment trial 28 mm Baseplate, 35° half-wedge augment trial	AR-9593-2415 AR-9593-2425 AR-9593-2435 AR-9593-2815 AR-9593-2825 AR-9593-2835
6	20 mm Modular Drill, half 25 mm Modular Drill, half 30 mm Modular Drill, half 35 mm Modular Drill, half 40 mm Modular Drill, half	AR-9596-20H AR-9596-25H AR-9596-30H AR-9596-35H AR-9596-40H
7	Angled Reamer Sleeve, 15°	AR-9597-15
8	Angled Reamer Sleeve, 25°	AR-9597-25
9	Retroverted Pin Guide	AR-9680
10	24/28 mm Depth Stop, 15° 24 mm Depth Stop, 25° 28 mm Depth Stop, 25° 24 mm Depth Stop, 35° 28 mm Depth Stop, 35°	AR-9598-15 AR-9598-2425 AR-9598-2825 AR-9598-2435 AR-9598-2835

Univers Revers™ Fracture Adapter



- Compatible with all sizes of Univers Revers humeral stems
- Suture holes for tuberosity fixation
- Machine-textured, grit-blasted, and hydroxyapatite (HA)-coated for bony ongrowth
- Narrow and wide sizes available:
 - Size 5: +11 mm
 - Sizes 6-9: +9.5 mm
 - Sizes 10-15: +7.5 mm
- Heights available as standard and +5 mm

Univers Revers™ Fracture Adapter (Cont.)

Implants

Product Description	Item Number
Fracture Adapter, sizes 6-9	AR-9501-FX6N
Fracture Adapter, sizes 6-9, wide	AR-9501-FX6W
Fracture Adapter, sizes 6-9, tall	AR-9501-FX6NT
Fracture Adapter, sizes 6-9, wide, tall	AR-9501-FX6WT
Fracture Adapter, sizes 10-15	AR-9501-FX10N
Fracture Adapter, sizes 10-15, wide	AR-9501-FX10W
Fracture Adapter, sizes 10-15, tall	AR-9501-FX10NT
Fracture Adapter, sizes 10-15, wide, tall	AR-9501-FX10WT
Fracture Adapter, size 5	AR-9501-FX5N
Fracture Adapter, size 5, wide	AR-9501-FX5W
Fracture Adapter Trunnion	AR-9501FTK

Disposables

Product Description	Item Number
FiberWire® Suture Kit	AR-7219
#2 FiberWire Suture (blue), 97 cm, w/ tapered needle, 26.5 mm, ½ circle, qty. 12	AR-7200
#2 FiberWire Suture, 97 cm, w/ reverse cutting needle, 36.6 mm, ½ circle, qty. 12	AR-7202
#5 FiberWire Suture (blue), 97 cm	AR-7210
#5 FiberWire Suture, 97 cm, w/ conventional cutting needle, 48 mm, ½ circle, qty. 12	AR-7211

Fracture Adapter Case (AR-9510FX)

Product Description	Item Number
Trial Fracture Adapter, size 5, narrow	AR-9510-FX5N
Trial Fracture Adapter, size 5, wide	AR-9510-FX5W
Trial Fracture Adapter, sizes 6- 9, narrow	AR-9510-FX6N
Trial Fracture Adapter, sizes 6- 9, wide	AR-9510-FX6W
Trial Fracture Adapter, sizes 6-9, narrow, tall	AR-9510-FX6NT
Trial Fracture Adapter, sizes 6-9, wide, tall	AR-9510-FX6WT
Trial Fracture Adapter, sizes 10-15, narrow	AR-9510-FX10N
Trial Fracture Adapter, sizes 10-15, wide	AR-9510-FX10W
Trial Fracture Adapter, sizes 10-15, narrow, tall	AR-9510-FX10NT
Trial Fracture Adapter, sizes 10-15, wide, tall	AR-9510-FX10NW
Fracture Adapter Impactor	AR-9510-F1
Fracture Adapter Extractor	AR-9510-F2
Fracture Adapter Extractor Shaft	AR-9510-F3

FxBridge™ Tuberosity Repair System (AR-9517)

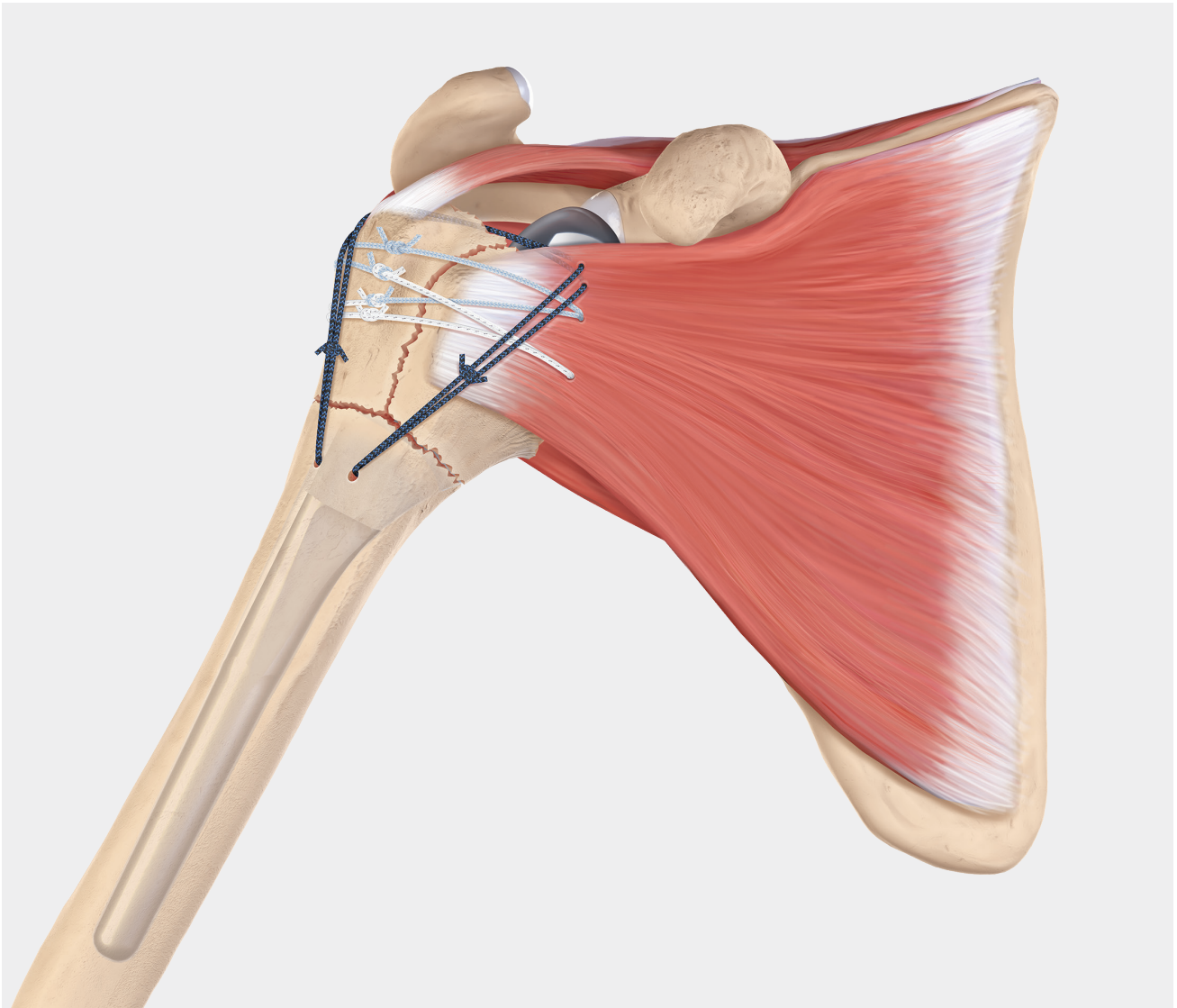

- All-inclusive kit streamlines repairs during a case
- Three distinct suture colors aid in suture management for a simple, reproducible repair
- Provides an environment for tuberosity healing, which improves postoperative range of motion (ROM)⁴
- FiberTape suture is 27% more resistant to tissue pull-through compared to round #2 suture⁵
- 135° humeral inclination increases tuberosity healing rate and stability⁶

Shoulder Arthroplasty Retractor Set

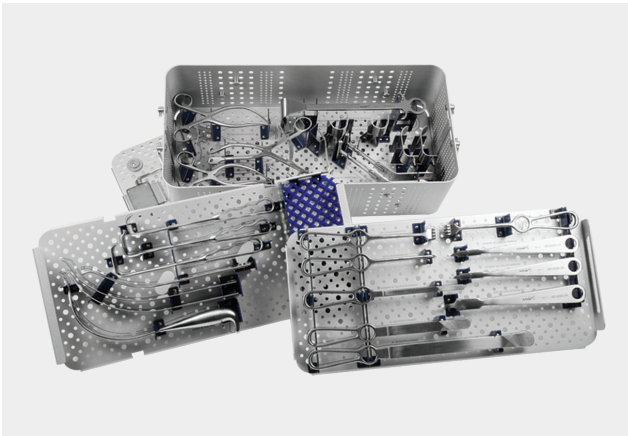

- More than 25 standard and specialty retractors
- Most extensive shoulder arthroplasty-specific retractor grouping on the market

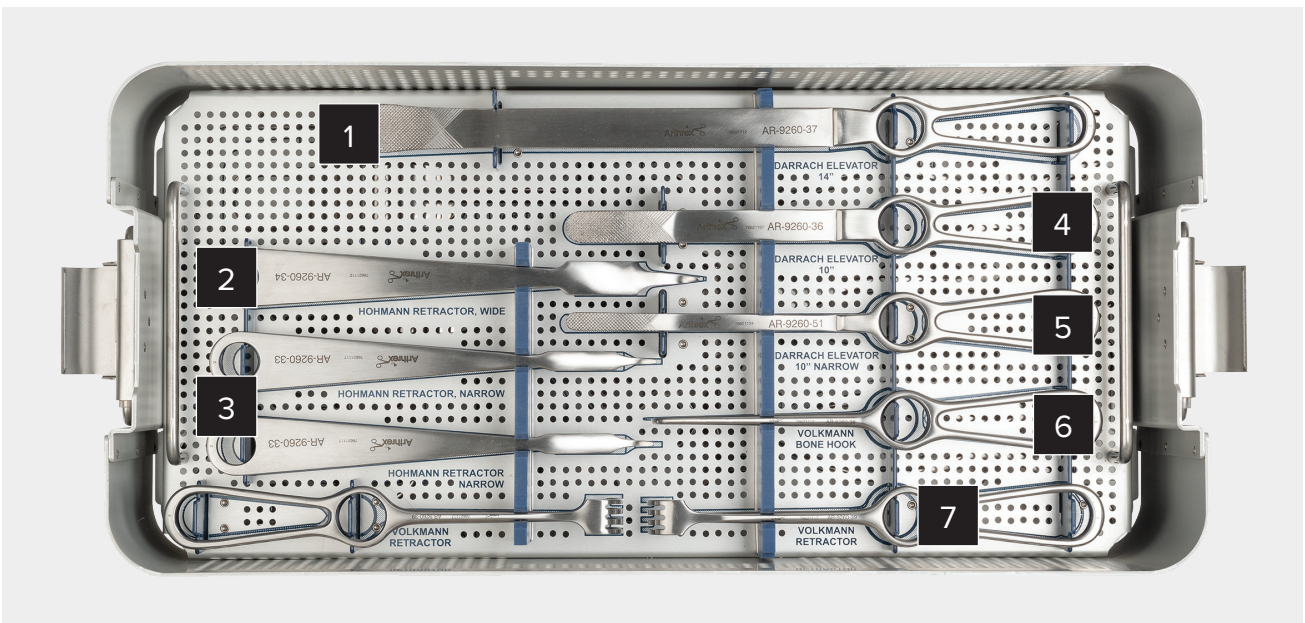

Shoulder Arthroplasty Retractor Set - Top Tray (AR-9260S-53)

Label	Product Description	Item Number
1	Darrach Elevator, 14 in (L) × 1 in (W)	AR-9260-37
2	Hohmann Retractor, wide	AR-9260-34
3	Hohmann Retractor, narrow	AR-9260-33
4	Darrach Elevator, 10 in (L) × 5/8 in (W)	AR-9260-36
5	Darrach Elevator, 10 in (L) × 3/8 in (W)	AR-9260-51
6	Volkman Bone Hook	AR-9260-38
7	Volkman "Rake" Retractor	AR-9260-39

Shoulder Arthroplasty Retractor Set (Cont.)

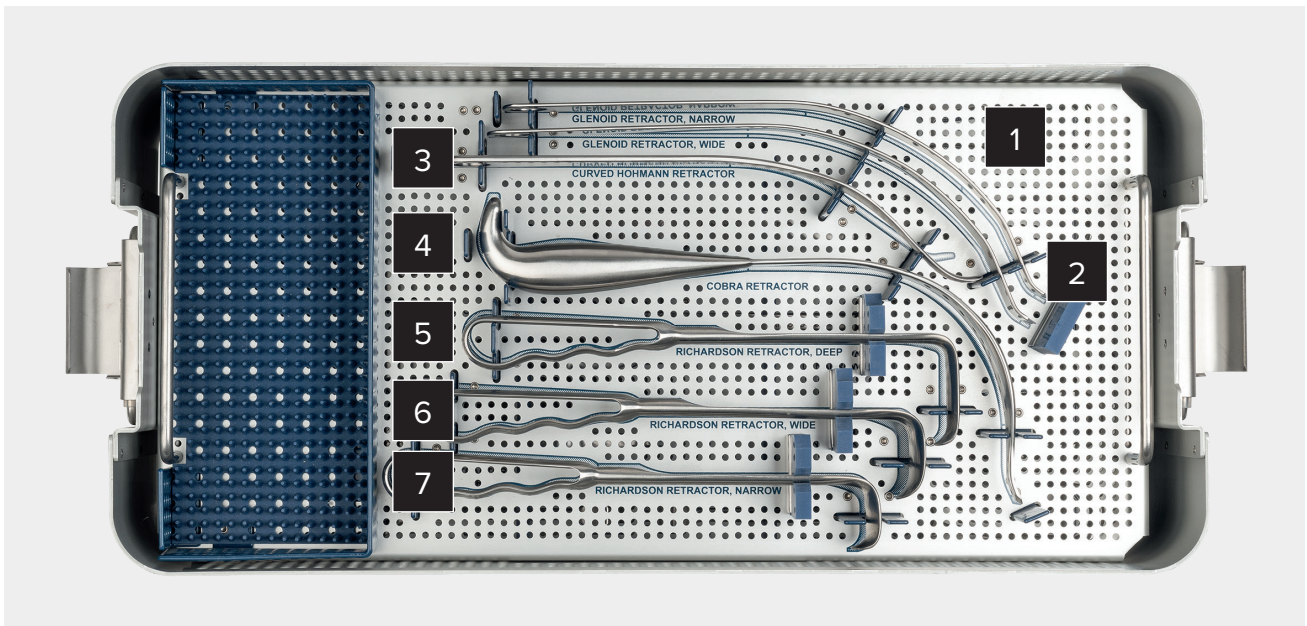

Shoulder Arthroplasty Retractor Set - Middle Tray (AR-9260S-53)

Label	Product Description	Item Number
1	Thin Glenoid Retractor, narrow tip	AR-9260-30
2	Thin Glenoid Retractor, wide tip	AR-9260-31
3	Hohmann Retractor, curved	AR-9260-35
4	Cobra Retractor	AR-9260-49
5	Richardson Retractor, deep	AR-9260-42
6	Richardson Retractor, wide	AR-9260-41
7	Richardson Retractor, narrow	AR-9260-40

Shoulder Arthroplasty Retractor Set (Cont.)

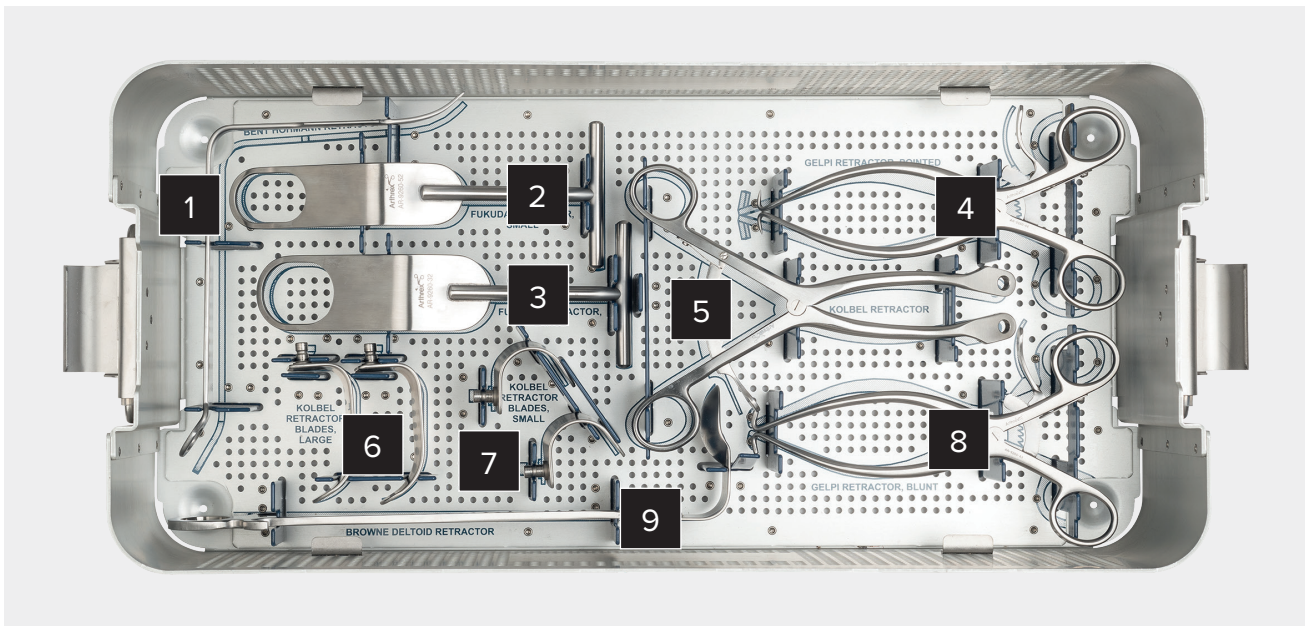

Shoulder Arthroplasty Retractor Set - Bottom Tray (AR-9260S-53)

Label	Product Description	Item Number
1	Hohmann Retractor, bent	AR-9260-48
2	Fukuda Retractor, small	AR-9260-52
3	Fukuda Retractor, large	AR-9260-32
4	Gelpi Retractor, sharp tip	AR-9260-44
5	Kolbel Retractor, ring handle	AR-9260-45
6	Kolbel Retractor Blades, large	AR-9260-47
7	Kolbel Retractor Blades, small	AR-9260-46
8	Gelpi Retractor, blunt tip	AR-9260-43
9	Browne Deltoid Retractor	AR-9260-50

Virtual Implant Positioning™ (VIP™) System



Optimized for Surgeon Control and Capability

- Team of dedicated surgical planners use the patient's uploaded CT data to develop a preoperative plan that is subsequently reviewed and adjusted, as necessary, by the surgeon
- 2-day turnaround once plan is approved
- Plan and easily switch between anatomic and reverse total shoulder arthroplasty cases
- Web-based portal available on desktop, mobile, and iOS tablet devices

Reusable, Adjustable, Patient-Specific Instrumentation

- Facilitates accurate, intraoperative placement of the glenoid guide pin based on the surgeon-approved preoperative plan
- The glenoid targeter (a) is used intraoperatively to transfer the planned glenoid guide pin position and trajectory from the software to the patient's anatomy
- The VIP glenoid reamer (b) can be used to transfer the desired depth of ream from the VIP plan to the patient's anatomy
- A 3D glenoid model (a) of the patient's anatomy can be ordered

MyVIP™ Texting Platform

- Delivers timely, automated text messages to guide patients through their presurgical journey
- Educate patients and ease anxiety-ridden waiting time
- Based on patients' MyVIP experience alone⁷:
 - 91% would refer their surgeon to a friend or family member
 - 97% understand why a CT scan was needed
 - 94% were satisfied with communication and information



Glenoid Targeter Instrument Set

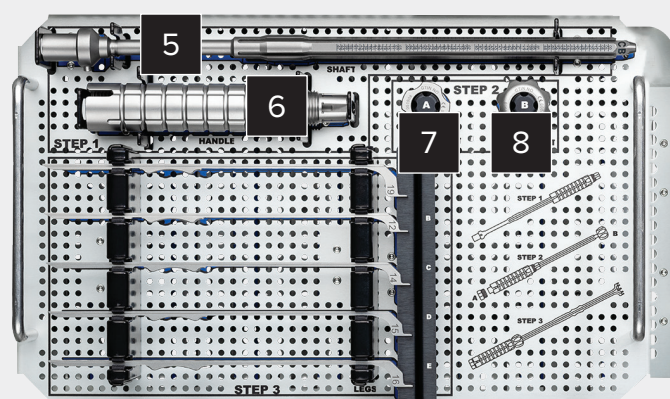
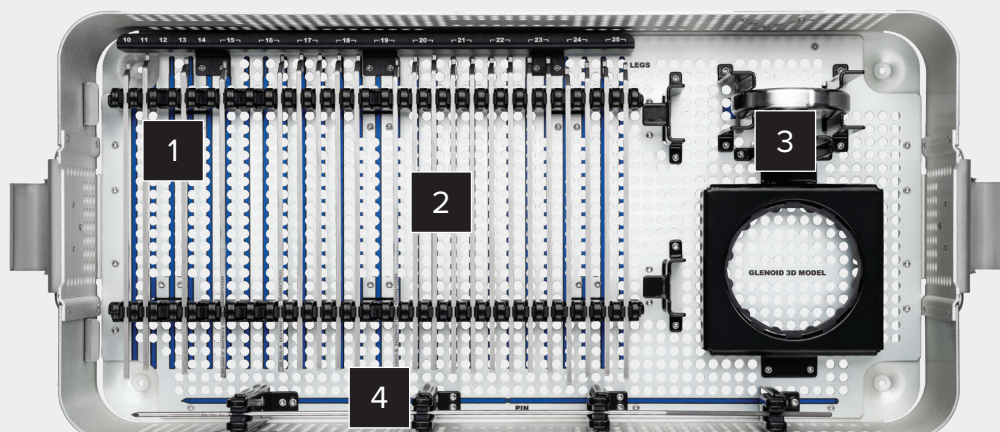

Glenoid Targeter Instrument Set - Case Base (DE-VIPTARG2-IN)

Label	Product Description	Item Number
1	Glenoid Targeter Leg, size 10	AR-5400-10
	Glenoid Targeter Leg, size 11	AR-5400-11
	Glenoid Targeter Leg, size 12	AR-5400-12
	Glenoid Targeter Leg, size 13	AR-5400-13
	Glenoid Targeter Leg, size 14	AR-5400-14
2	Glenoid Targeter Leg, size 15	AR-5400-15
	Glenoid Targeter Leg, size 16	AR-5400-16
	Glenoid Targeter Leg, size 17	AR-5400-17
	Glenoid Targeter Leg, size 18	AR-5400-18
	Glenoid Targeter Leg, size 19	AR-5400-19
	Glenoid Targeter Leg, size 20	AR-5400-20
	Glenoid Targeter Leg, size 21	AR-5400-21
	Glenoid Targeter Leg, size 22	AR-5400-22
	Glenoid Targeter Leg, size 23	AR-5400-23
	Glenoid Targeter Leg, size 24	AR-5400-24
	Glenoid Targeter Leg, size 25	AR-5400-25
3	VIP™ Glenoid 3D Model Base	AR-VIPBASE
4	2.8 mm Pin, stainless steel	AR-5400-400

Glenoid Targeter Instrument Set - Case Insert (DE-VIPTARG2-IN)

Label	Product Description	Item Number
5	Glenoid Targeter Shaft	AR-5400-01
6	Glenoid Targeter Handle	AR-5400-02
7	Glenoid Targeter Capture Nut	AR-5400-03
8	Glenoid Targeter Locking Nut	AR-5400-04

Disposables

Product Description	Item Number
DynaNite® VIP Glenoid Pin, nitinol, 2.8 mm	AR-5400-400NS

VIP™ Glenoid Reaming System Set

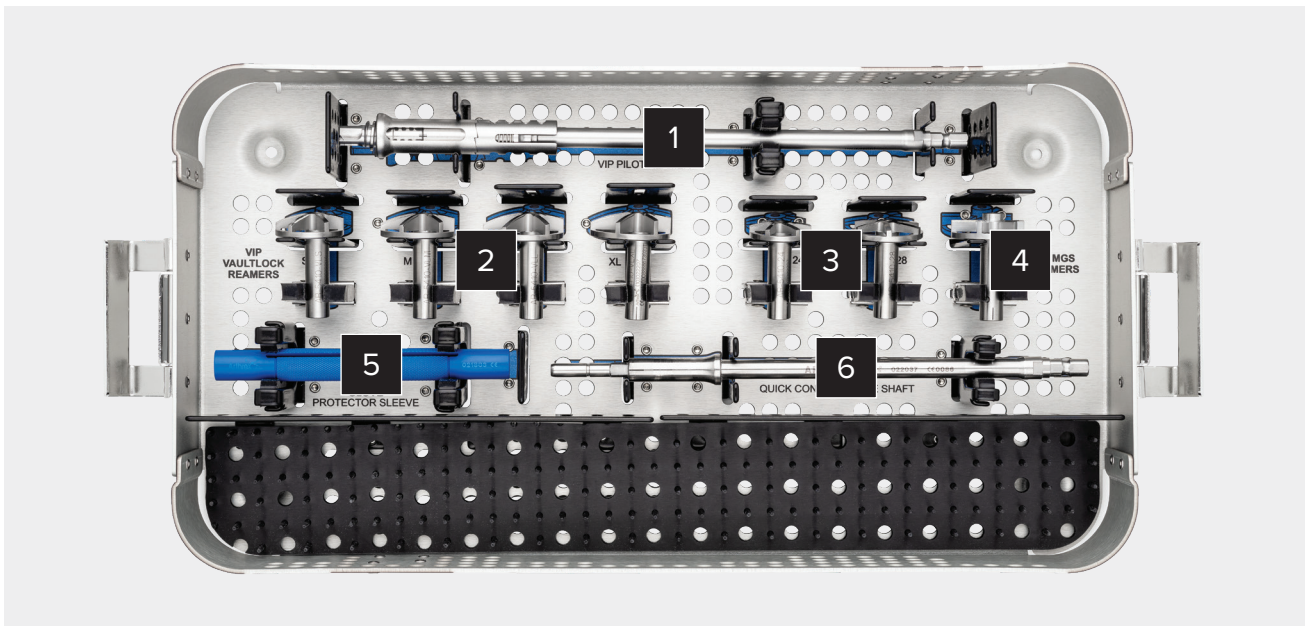

VIP Glenoid Reaming System Set - Reusable Instruments (AR-5410S)

Label	Product Description	Item Number
1	Virtual Implant Positioning™ Glenoid Reamer, pilot	AR-5410-01
2	VIP Glenoid Reamer, Uniers VaultLock® glenoid, small VIP Glenoid Reamer, Uniers VaultLock glenoid, medium VIP Glenoid Reamer, Uniers VaultLock glenoid, large VIP Glenoid Reamer, Uniers VaultLock glenoid, X-large	AR-5410-VLS AR-5410-VLM AR-5410-VLL AR-5410-VLXL
3	VIP Glenoid Reamer, Uniers Revers™ MGS, 24 mm VIP Glenoid Reamer, Uniers Revers MGS, 28 mm	AR-5410-24 AR-5410-28
4	VIP Glenoid Reamer, paleo	AR-5410-P
5	Glove Protector Sleeve	AR-9216-4
6	Modular Reamer Shaft	AR-9617

Disposables

Product Description	Item Number
VIP Glenoid Reamer, Uniers Revers Augmented MGS, small	AR-5410-AMGS-S
VIP Glenoid Reamer, Uniers Revers Augmented MGS, medium	AR-5410-AMGS-M
VIP Glenoid Reamer, Uniers Revers Augmented MGS, large	AR-5410-AMGS-L

Knee Arthroplasty

Solutions for Partial Knee Replacement

iBalance® UKA System.....	68
UKA Instrumentation Set 1	71
UKA Instrumentation Set 2.....	75
iBalance® PFJ System.....	77
iBalance® PFJ.....	78
Patellar Resection System	80
Instruments.....	81



Unicondylar Knee Arthroplasty

- Only UKA implant that allows independent flexion and extension gap balancing
- Patented keel design resists anterior shear forces and anchors the tibial implants
- Tibial cortical support is preserved through all aspects of instrument fixation
- Independent control of flexion and extension space provide uncompromising joint line control, ligament balancing, bone preservation, and kinematic restoration
- Femoral thickness of 7 mm distal, posterior, and at midflexion
- Tibial thickness options range from 8 mm to 12 mm in 1 mm increments; 14 mm option also available
- Overall composite thickness between 15 mm and 21 mm

iBalance® UKA System (Cont.)

Implants

Product Description	Item Number
Femoral Components	
Femoral Component, size 1, LM	AR-501-UFLA
Femoral Component, size 2, LM	AR-501-UFLB
Femoral Component, size 3, LM	AR-501-UFLC
Femoral Component, size 4, LM	AR-501-UFLD
Femoral Component, size 5, LM	AR-501-UFLE
Femoral Component, size 6, LM	AR-501-UFLF
Femoral Component, size 1, RM	AR-501-UFRA
Femoral Component, size 2, RM	AR-501-UFRB
Femoral Component, size 3, RM	AR-501-UFRC
Femoral Component, size 4, RM	AR-501-UFRD
Femoral Component, size 5, RM	AR-501-UFRE
Femoral Component, size 6, RM	AR-501-UFRF
Tibial Components	
Tibial Tray Component, size 1, LM	AR-511-T1L
Tibial Tray Component, size 2, LM	AR-511-T2L
Tibial Tray Component, size 3, LM	AR-511-T3L
Tibial Tray Component, size 4, LM	AR-511-T4L
Tibial Tray Component, size 5, LM	AR-511-T5L
Tibial Tray Component, size 6, LM	AR-511-T6L
Tibial Tray Component, size 1, RM	AR-511-T1R
Tibial Tray Component, size 2, RM	AR-511-T2R
Tibial Tray Component, size 3, RM	AR-511-T3R
Tibial Tray Component, size 4, RM	AR-511-T4R
Tibial Tray Component, size 5, RM	AR-511-T5R
Tibial Tray Component, size 6, RM	AR-511-T6R

Product Description	Item Number
Polyethylene Components, vit E	
Tibial Bearing, size 1, 8 mm, vit E	AR-521-TBA8
Tibial Bearing, size 1, 9 mm, vit E	AR-521-TBA9
Tibial Bearing, size 1, 10 mm, vit E	AR-521-TBA0
Tibial Bearing, size 1, 11 mm, vit E	AR-521-TBA1
Tibial Bearing, size 1, 12 mm, vit E	AR-521-TBA2
Tibial Bearing, size 2, 8 mm, vit E	AR-521-TBB8
Tibial Bearing, size 2, 9 mm, vit E	AR-521-TBB9
Tibial Bearing, size 2, 10 mm, vit E	AR-521-TBB0
Tibial Bearing, size 2, 11 mm, vit E	AR-521-TBB1
Tibial Bearing, size 2, 12 mm, vit E	AR-521-TBB2
Tibial Bearing, size 3, 8 mm, vit E	AR-521-TBC8
Tibial Bearing, size 3, 9 mm, vit E	AR-521-TBC9
Tibial Bearing, size 3, 10 mm, vit E	AR-521-TBC0
Tibial Bearing, size 3, 11 mm, vit E	AR-521-TBC1
Tibial Bearing, size 3, 12 mm, vit E	AR-521-TBC2
Tibial Bearing, size 3, 14 mm, vit E	AR-521-Tb(A-F)4
Tibial Bearing, size 4, 8 mm, vit E	AR-521-TBD8
Tibial Bearing, size 4, 9 mm, vit E	AR-521-TBD9
Tibial Bearing, size 4, 10 mm, vit E	AR-521-TBD0
Tibial Bearing, size 4, 11 mm, vit E	AR-521-TBD1
Tibial Bearing, size 4, 12 mm, vit E	AR-521-TBD2
Tibial Bearing, size 5, 8 mm, vit E	AR-521-TBE8
Tibial Bearing, size 5, 9 mm, vit E	AR-521-TBE9
Tibial Bearing, size 5, 10 mm, vit E	AR-521-TBE0
Tibial Bearing, size 5, 11 mm, vit E	AR-521-TBE1
Tibial Bearing, size 5, 12 mm, vit E	AR-521-TBE2
Tibial Bearing, size 6, 8 mm, vit E	AR-521-TBF8
Tibial Bearing, size 6, 9 mm, vit E	AR-521-TBF9
Tibial Bearing, size 6, 10 mm, vit E	AR-521-TBF0
Tibial Bearing, size 6, 11 mm, vit E	AR-521-TBF1
Tibial Bearing, size 6, 12 mm, vit E	AR-521-TBF2

Optional Instruments

Product Description	Item Number
Disposable Tibial Cutting Guide Left	AR-621-TL2
Disposable Tibial Cutting Guide Right	AR-621-TR2
iBalance UKA Tibial Fixation Buttress	AR-611-5
iBalance UKA Tibial Trialing Shim, 2/3 mm	AR-611-7
iBalance UKA Tibia Trialing Shim, 4/5 mm	AR-611-13
iBalance UKA Femoral Peg Drill, ø 0.312 mm	AR-601-FPDO
iBalance UKA Tibial Peg Drill, ø 0.312 mm	AR-601-TPDO
iBalance UKA Tibial Trial Handle	AR-611-18
EM Tibial Guide, long distal body	AR-623-32
Tibial Recut Guide	AR-601-TCCG-2

iBalance® UKA System (Cont.)

Optional Spacer Block Organization (AR-611-SC1 and AR-611-SC2)

Product Description	Item Number	AR-611-SC1	AR-611-SC2	AR-611-SCA
iBalance UKA Space Block Caddy, 11 spaces	AR-611-C3	✓		
iBalance UKA Space Block Caddy, 12 spaces	AR-611-C4		✓	
iBalance UKA Spacer Block, 6 mm	AR-611-SB06	✓		
iBalance UKA Spacer Block, 7 mm	AR-611-SB07	✓		
iBalance UKA Spacer Block, 8 mm	AR-611-SB08	✓	✓	
iBalance UKA Spacer Block, 9 mm	AR-611-SB09	✓	✓	
iBalance UKA Spacer Block, 10 mm	AR-611-SB10	✓	✓	
iBalance UKA Spacer Block, 11 mm	AR-611-SB11		✓	
iBalance UKA Spacer Block, 12 mm	AR-611-SB12		✓	
iBalance UKA Spacer Block, 14 mm	AR-611-SB14		✓	
iBalance UKA Spacer Block, 15 mm	AR-611-SB15	✓	✓	✓
iBalance UKA Spacer Block, 16 mm	AR-611-SB16	✓	✓	✓
iBalance UKA Spacer Block, 17 mm	AR-611-SB17	✓	✓	✓
iBalance UKA Spacer Block, 18 mm	AR-611-SB18	✓	✓	✓
iBalance UKA Spacer Block, 19 mm	AR-611-SB19		✓	
iBalance UKA Spacer Block, 21 mm	AR-611-SB21		✓	
iBalance UKA Spacer Block Caddy, adjustable	AR-611-C5			✓
Adjustable Spacer Block	AR-611-20			✓
Lamina Spreader	AR-1340T			✓

UKA Instrumentation Set 1

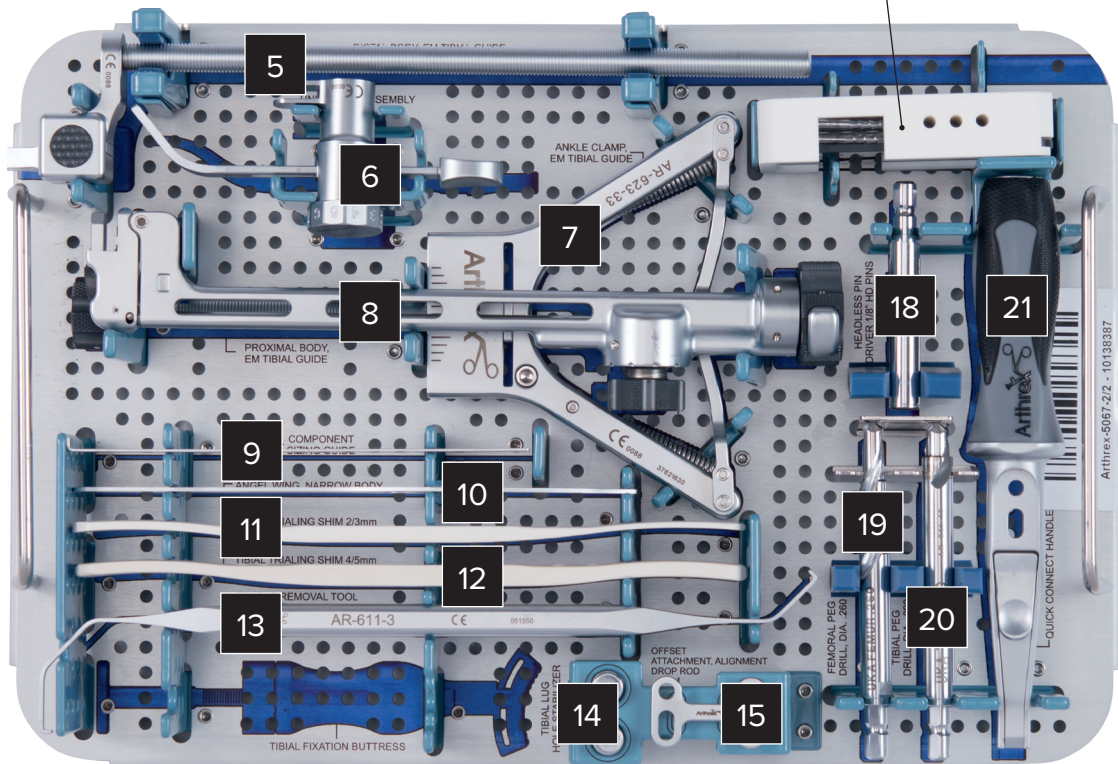

UKA Instrumentation Set 1 (Cont.)

UKA Instrumentation Set 1, Top Tray (AR-611-C1)

Label	Product Description	Item Number
1	iBalance® UKA Spacer Block, 6 mm	AR-611-SB06
	iBalance UKA Spacer Block, 7 mm	AR-611-SB07
	iBalance UKA Spacer Block, 8 mm	AR-611-SB08
	iBalance UKA Spacer Block, 9 mm	AR-611-SB09
	iBalance UKA Spacer Block, 10 mm	AR-611-SB10
	iBalance UKA Spacer Block, 15 mm	AR-611-SB15
	iBalance UKA Spacer Block, 16 mm	AR-611-SB16
	iBalance UKA Spacer Block, 17 mm	AR-611-SB17
	iBalance UKA Spacer Block, 18 mm	AR-611-SB18
2	iBalance UKA Modular Spacer Block, 5 mm	AR-611-SM05
	iBalance UKA Modular Spacer Block, 10 mm	AR-611-SM10
3	iBalance Patella Calipers	AR-602-48
4	iBalance UKA Quick-Connect Handle, short	AR-611-8
5	Short Distal Body, EM tibial guide	AR-623-31
6	UKA Tibial Stylus, adjustable	AR-611-17
7	Ankle Clamp EM Tibial Guide	AR-623-33
8	Proximal Body, EM tibial guide	AR-623-30
9	Tibia Measuring Guide	AR-611-14
10	Angel Wing, narrow body	AR-623-76
11	iBalance UKA Tibia Trialing Shim, 2/3 mm	AR-611-7
12	iBalance UKA Shim, 1/5 mm	AR-611-13
13	iBalance UKA Cement Removal Tool	AR-611-3
14	iBalance UKA Tibial Lug Hole Stabilizer	AR-611-12
15	iBalance UKA Offset Attachment Alignment, Drop Rod	AR-611-1
16	Threaded Pin, headed, short	AR-611-15
17	iBalance UKA Trocar Pin Driver, smooth	AR-613-50
18	iBalance UKA Headless Pin Driver	AR-613-91
19	iBalance UKA Femoral Peg Drill, Ø0.260	AR-611-11
20	iBalance UKA Tibia Peg Drill	AR-611-10
21	iBalance UKA Quick-Connect Handle, short	AR-611-8

UKA Instrumentation Set 1 (Cont.)

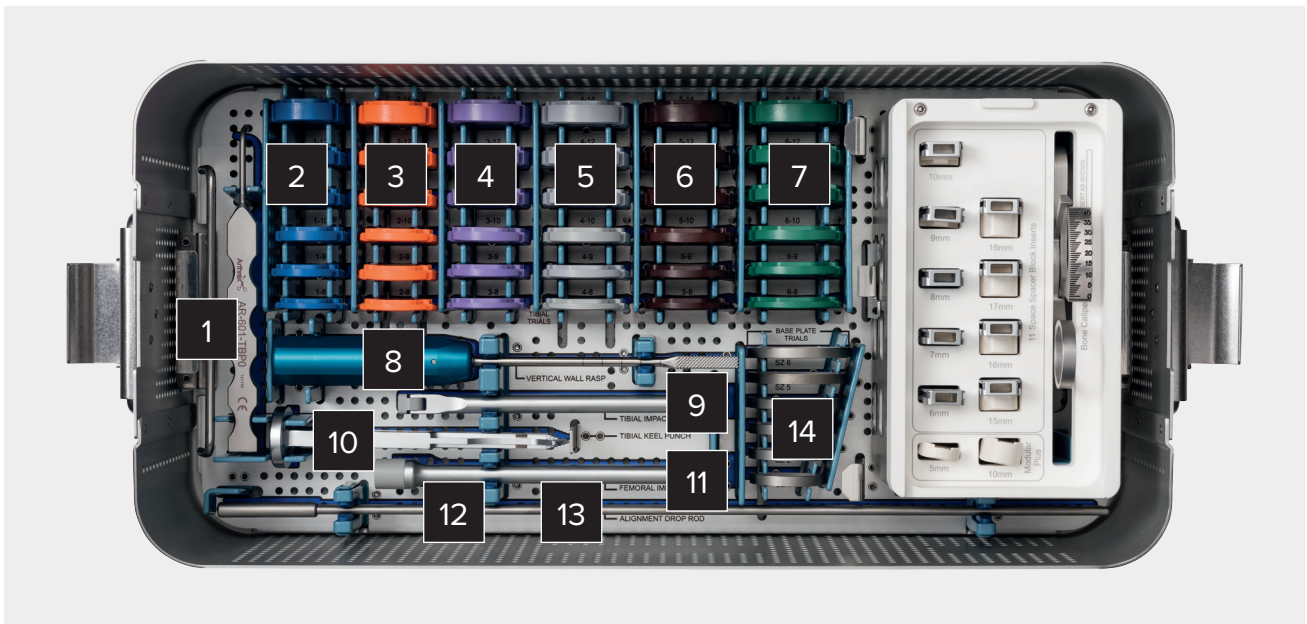

UKA Instrumentation Set 1, Bottom Tray (AR-611-S1)

Label	Product Description	Item Number
1	iBalance® UKA, Trial Bearing Puller	AR-601-TBP0
2	iBalance UKA Tibial Bearing Trial, size 1, 10 mm iBalance UKA Tibial Bearing Trial, size 1, 11 mm iBalance UKA Tibial Bearing Trial, size 1, 12 mm iBalance UKA Tibial Bearing Trial, size 1, 14 mm iBalance UKA Tibial Bearing Trial, size 1, 8 mm iBalance UKA Tibial Bearing Trial, size 1, 9 mm	AR-601-TBA0 AR-601-TBA1 AR-601-TBA2 AR-601-TBA4 AR-601-TBA8 AR-601-TBA9
3	iBalance UKA Tibial Bearing Trial, size 2, 10 mm iBalance UKA Tibial Bearing Trial, size 2, 11 mm iBalance UKA Tibial Bearing Trial, size 2, 12 mm iBalance UKA Tibial Bearing Trial, size 2, 14 mm iBalance UKA Tibial Bearing Trial, size 2, 8 mm iBalance UKA Tibial Bearing Trial, size 2, 9 mm	AR-601-TBB0 AR-601-TBB1 AR-601-TBB2 AR-601-TBB4 AR-601-TBB8 AR-601-TBB9
4	iBalance UKA Tibial Bearing Trial, size 3, 10 mm iBalance UKA Tibial Bearing Trial, size 3, 11 mm iBalance UKA Tibial Bearing Trial, size 3, 12 mm iBalance UKA Tibial Bearing Trial, size 3, 14 mm iBalance UKA Tibial Bearing Trial, size 3, 8 mm iBalance UKA Tibial Bearing Trial, size 3, 9 mm	AR-601-TBC0 AR-601-TBC1 AR-601-TBC2 AR-601-TBC4 AR-601-TBC8 AR-601-TBC9
5	iBalance UKA Tibial Bearing Trial, size 4, 10 mm iBalance UKA Tibial Bearing Trial, size 4, 11 mm iBalance UKA Tibial Bearing Trial, size 4, 12 mm iBalance UKA Tibial Bearing Trial, size 4, 14 mm iBalance UKA Tibial Bearing Trial, size 4, 8 mm iBalance UKA Tibial Bearing Trial, size 4, 9 mm	AR-601-TBD0 AR-601-TBD1 AR-601-TBD2 AR-601-TBD4 AR-601-TBD8 AR-601-TBD9
6	iBalance UKA Tibial Bearing Trial, size 5, 10 mm iBalance UKA Tibial Bearing Trial, size 5, 11 mm iBalance UKA Tibial Bearing Trial, size 5, 12 mm iBalance UKA Tibial Bearing Trial, size 5, 14 mm iBalance UKA Tibial Bearing Trial, size 5, 8 mm iBalance UKA Tibial Bearing Trial, size 5, 9 mm	AR-601-TBE0 AR-601-TBE1 AR-601-TBE2 AR-601-TBE4 AR-601-TBE8 AR-601-TBE9

UKA Instrumentation Set 1 (Cont.)

UKA Instrumentation Set 1, Bottom Tray (AR-611-S1)

Label	Product Description	Item Number
7	iBalance® UKA Tibial Bearing Trial, size 6, 10 mm iBalance UKA Tibial Bearing Trial, size 6, 11 mm iBalance UKA Tibial Bearing Trial, size 6, 12 mm iBalance UKA Tibial Bearing Trial, size 6, 14 mm iBalance UKA Tibial Bearing Trial, size 6, 8 mm iBalance UKA Tibial Bearing Trial, size 6, 9 mm	AR-601-TBF0 AR-601-TBF1 AR-601-TBF2 AR-601-TBF4 AR-601-TBF8 AR-601-TBF9
8	Dilating Rasp, slot, meniscal allograft	AR-2963BR
9	iBalance UKA, femoral impactor	AR-611-6
10	iBalance UKA SportsPlasty™ Tibial Keel Punch	AR-611-9
11	iBalance UKA Tibial Impactor	AR-611-4
12	iBalance UKA Alignment Drop Rod w / Sleeve, 3/16 in × 18 in	AR-611-2
13	iBalance UKA, Alignment Rod, 3/16 in × 18 in	AR-601-AR00
14	iBalance UKA Base Plate, size 1 iBalance UKA Base Plate, size 2 iBalance UKA Base Plate, size 3 iBalance UKA Base Plate, size 4 iBalance UKA Base Plate, size 5 iBalance UKA Base Plate, size 6	AR-601-TBP1 AR-601-TBP2 AR-601-TBP3 AR-601-TBP4 AR-601-TBP5 AR-601-TBP6

UKA Instrumentation Set 2

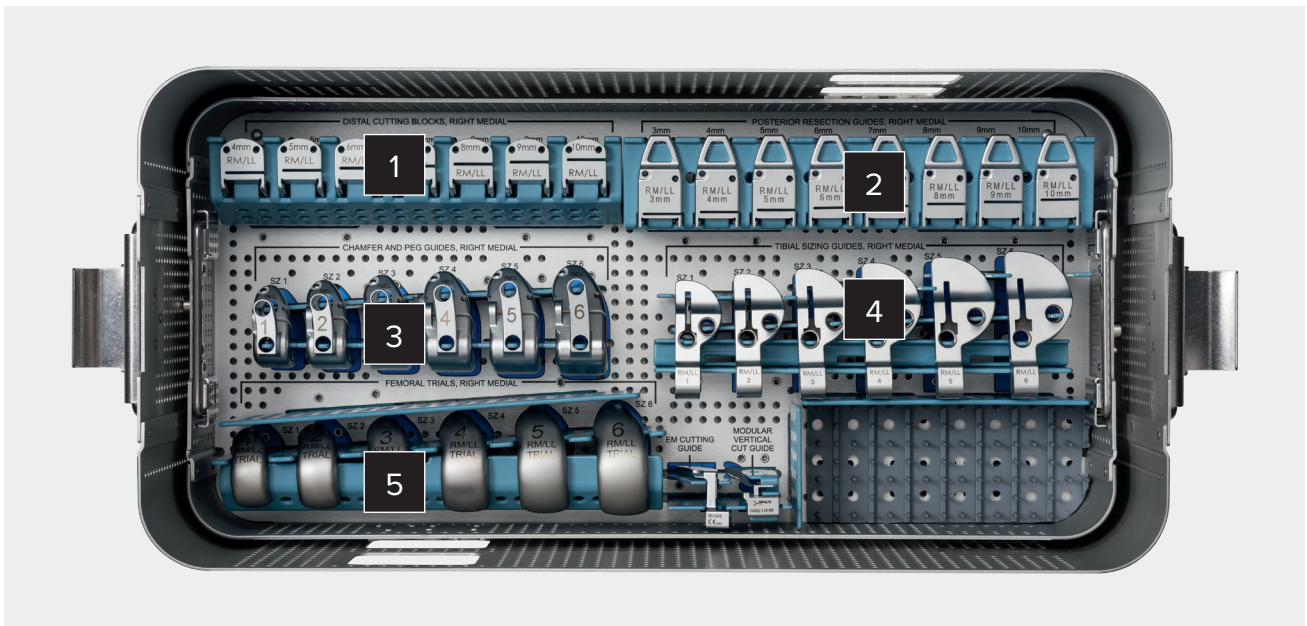

UKA Instrumentation Set 2, Right Medial Inner Tray (AR-611-C2R)

Label	Product Description	Item Number
1	iBalance® UKA RM/LL Distal Cut 4 mm Block iBalance UKA RM/LL Distal Cut 5 mm Block iBalance UKA RM/LL Distal Cut 6 mm Block iBalance UKA RM/LL Distal Cut 7 mm Block iBalance UKA RM/LL Distal Cut 8 mm Block iBalance UKA RM/LL Distal Cut 9 mm Block iBalance UKARM/LL Distal Cut 10 mm Block	AR-611-DR04 AR-611-DR05 AR-611-DR06 AR-611-DR07 AR-611-DR08 AR-611-DR09 AR-611-DR10
2	iBalance UKA RM/LL Post Cut 3 mm Block iBalance UKA RM/LL Post Cut 4 mm Block iBalance UKA RM/LL Post Cut 5 mm Block iBalance UKA RM/LL Post Cut 6 mm Block iBalance UKA RM/LL Post Cut 7 mm Block iBalance UKA RM/LL Post Cut 8 mm Block iBalance UKA RM/LL Post Cut 9 mm Block iBalance UKA RM/LL Post Cut 10 mm Block	AR-611-PR03 AR-611-PR04 AR-611-PR05 AR-611-PR06 AR-611-PR07 AR-611-PR08 AR-611-PR09 AR-611-PR10
3	iBalance UKA Femoral Finish Guide, size 1, RM/LL iBalance UKA Femoral Finish Guide, size 2, RM/LL iBalance UKA Femoral Finish Guide, size 3, RM/LL iBalance UKA Femoral Finish Guide, size 4, RM/LL iBalance UKA Femoral Finish Guide, size 5, RM/LL iBalance UKA Femoral Finish Guide, size 6, RM/LL	AR-611-CR1 AR-611-CR2 AR-611-CR3 AR-611-CR4 AR-611-CR5 AR-611-CR6
4	iBalance UKA RM/LL Tibial Finish Guide 1 iBalance UKA RM/LL Tibial Finish Guide 2 iBalance UKA RM/LL Tibial Finish Guide 3 iBalance UKA RM/LL Tibial Finish Guide 4 iBalance UKA RM/LL Tibial Finish Guide 5 iBalance UKA RM/LL Tibial Finish Guide 6	AR-611-TR1 AR-611-TR2 AR-611-TR3 AR-611-TR4 AR-611-TR5 AR-611-TR6
5	iBalance UKA Femoral Trial, size 1, RM/LL iBalance UKA Femoral Trial, size 2, RM/LL iBalance UKA Femoral Trial, size 3, RM/LL iBalance UKA Femoral Trial, size 4, RM/LL iBalance UKA Femoral Trial, size 5, RM/LL iBalance UKA Femoral Trial, size 6, RM/LL	AR-601-FTRA AR-601-FTRB AR-601-FTRC AR-601-FTRD AR-601-FTRE AR-601-FTRF

UKA Instrumentation Set 2 (Cont.)

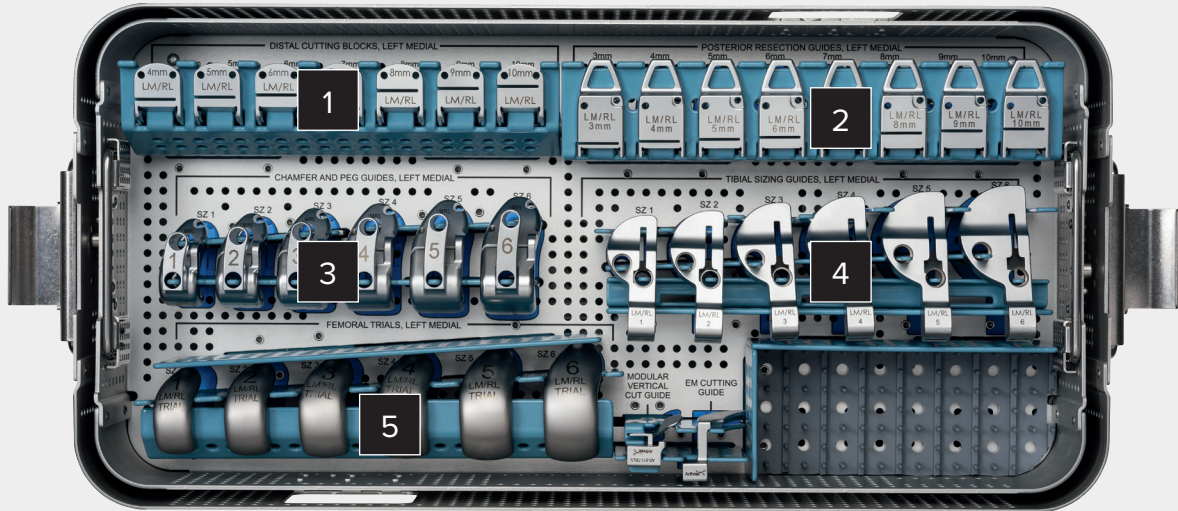

UKA Instrumentation Set 2, Left Medial Inner Tray (AR-611-C2L)

Label	Product Description	Item Number
1	iBalance® UKA LM/RL Distal Cut 4 mm Block iBalance UKA LM/RL Distal Cut 5 mm Block iBalance UKA LM/RL Distal Cut 6 mm Block iBalance UKA LM/RL Distal Cut 7 mm Block iBalance UKA LM/RL Distal Cut 8 mm Block iBalance UKA LM/RL Distal Cut 9 mm Block iBalance UKA LM/RL Distal Cut 10 mm Block	AR-611-DL04 AR-611-DL05 AR-611-DL06 AR-611-DL07 AR-611-DL08 AR-611-DL09 AR-611-DL10
2	iBalance UKA LM/RL Post Cut 3 mm Block iBalance UKA LM/RL Post Cut 4 mm Block iBalance UKA LM/RL Post Cut 5 mm Block iBalance UKA LM/RL Post Cut 6 mm Block iBalance UKA LM/RL Post Cut 7 mm Block iBalance UKA LM/RL Post Cut 8 mm Block iBalance UKA LM/RL Post Cut 9 mm Block iBalance UKA LM/RL Post Cut 10 mm Block	AR-611-PL03 AR-611-PL04 AR-611-PL05 AR-611-PL06 AR-611-PL07 AR-611-PL08 AR-611-PL09 AR-611-PL10
3	iBalance UKA Femoral Finish Guide, size 1 LM/RL iBalance UKA Femoral Finish Guide, size 2 LM/RL iBalance UKA Femoral Finish Guide, size 3 LM/RL iBalance UKA Femoral Finish Guide, size 4 LM/RL iBalance UKA Femoral Finish Guide, size 5 LM/RL iBalance UKA Femoral Finish Guide, size 6 LM/RL	AR-611-CL1 AR-611-CL2 AR-611-CL3 AR-611-CL4 AR-611-CL5 AR-611-CL6
4	iBalance UKA LM/RL Tibial Finish Guide 1 iBalance UKA LM/RL Tibial Finish Guide 2 iBalance UKA LM/RL Tibial Finish Guide 3 iBalance UKA LM/RL Tibial Finish Guide 4 iBalance UKA LM/RL Tibial Finish Guide 5 iBalance UKA LM/RL Tibial Finish Guide 6	AR-611-TL1 AR-611-TL2 AR-611-TL3 AR-611-TL4 AR-611-TL5 AR-611-TL6
5	iBalance UKA Femoral Trial, size 1, LM/RL iBalance UKA Femoral Trial, size 2, LM/RL iBalance UKA Femoral Trial, size 3, LM/RL iBalance UKA Femoral Trial, size 4, LM/RL iBalance UKA Femoral Trial, size 5, LM/RL iBalance UKA Femoral Trial, size 6, LM/RL	AR-601-FTLA AR-601-FTLB AR-601-FTLC AR-601-FTLD AR-601-FTLE AR-601-FTLF



Patellofemoral Joint Arthroplasty

- Simplified onlay system with the benefits of trochlear inlay techniques
- Efficient, single-tray system designed for use in the ASC minimizes sterilization costs and turnover times and helps ensure predictable, reproducible patellofemoral arthroplasty procedures
- Precisely prepare the trochlea to match the underside geometry of the implant with the anterior femoral resection guide and captured jig
- Low-profile, anatomic trochlear implant—available in 4 sizes—articulates with a round dome, 3-peg patellar component

Implants

Product Description	Item Number
Trochlear Components	
iBalance Patellofemoral Implant, left, size 1	AR-502-1L
iBalance Patellofemoral Implant, left, size 2	AR-502-2L
iBalance Patellofemoral Implant, left, size 3	AR-502-3L
iBalance Patellofemoral Implant, left, size 4	AR-502-4L
iBalance Patellofemoral Implant, right, size 1	AR-502-1R
iBalance Patellofemoral Implant, right, size 2	AR-502-2R
iBalance Patellofemoral Implant, right, size 3	AR-502-3R
iBalance patellofemoral Implant, right, size 4	AR-502-4R
Patellar Components	
iBalance Patella Implant Dome, 27 mm/8 mm, vit E	AR-524-PSA8
iBalance Patella Implant Dome, 30 mm/8 mm, vit E	AR-524-PSB8
iBalance Patella Implant Dome, 32 mm/8 mm, vit E	AR-524-PS328
iBalance Patella Implant Dome, 34 mm/9 mm, vit E	AR-524-PSC9
iBalance Patella Implant Dome, 37 mm/10 mm, vit E	AR-524-PSD0
iBalance Patella Implant Dome, 40 mm/10 mm, vit E	AR-524-PSE0

iBalance PFJ Finishing Blades (Each kit includes 3 blades [distal, medial, and proximal])

Product Description	Item Number
Finishing Blades, size 1 mm	AR-602-26
Finishing Blades, size 2 mm	AR-602-27
Finishing Blades, size 3 mm	AR-602-28
Finishing Blades, size 4 mm	AR-602-29

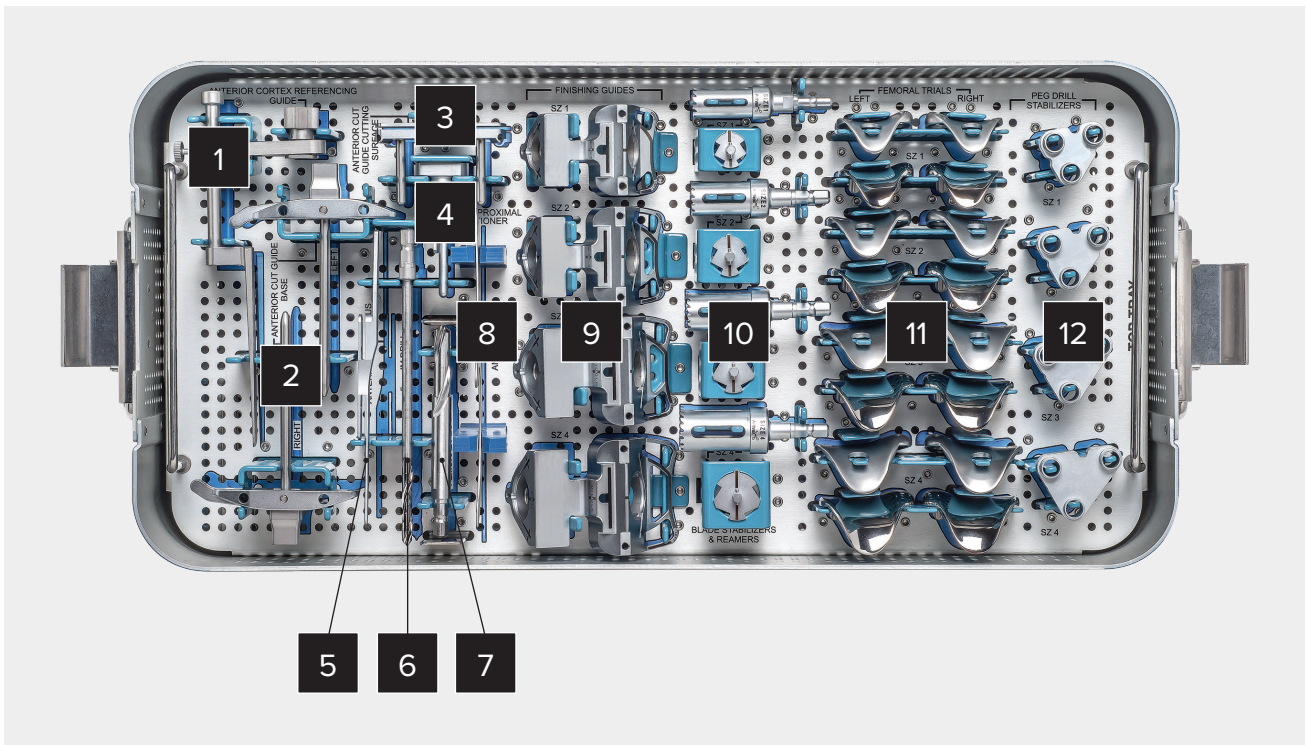

iBalance PFJ, Top Tray (AR-602-S)

Label	Product Description	Item Number
1	Anterior Cortex Alignment Guide	AR-602-5
2	Anterior Cut Guide Base, left Anterior Cut Guide Base, right	AR-602-8L AR-602-8R
3	Anterior Cut Guide	AR-602-9
4	Distal/Proximal Stylus	AR-602-15
5	Anterior Cut Stylus	AR-602-10
6	IM Drill	AR-602-6
7	Femoral Peg Drill, Ø 0.312 in	AR-602-42
8	Angel Wing	AR-613-76
9	Finishing Guide, size 1 Finishing Guide, size 2 Finishing Guide, size 3 Finishing Guide, size 4	AR-602-11 AR-602-12 AR-602-13 AR-602-14
10	Trochlear Reamer, size 1 Trochlear Reamer, size 2 Trochlear Reamer, size 3 Trochlear Reamer, size 4 Blade Stabilizer, size 1 Blade Stabilizer, size 2 Blade Stabilizer, size 3 Blade Stabilizer, size 4	AR-602-16 AR-602-17 AR-602-18 AR-602-19 AR-602-20 AR-602-21 AR-602-22 AR-602-23

Label	Product Description	Item Number
11	iBalance Femoral Trial, size 1, left	AR-602-1L
	iBalance Femoral Trial, size 1, right	AR-602-1R
	iBalance Femoral Trial, size 2, left	AR-602-2L
	iBalance Femoral Trial, size 2, right	AR-602-2R
	iBalance Femoral Trial, size 3, left	AR-602-3L
	iBalance Femoral Trial, size 3, right	AR-602-3R
	iBalance Femoral Trial, size 4, left	AR-602-4L
	iBalance Femoral Trial, size 4, right	AR-602-4R
	iBalance PFJ Pegged Femoral Trial, size 1, left	AR-602-50
	iBalance PFJ Pegged Femoral Trial, size 2, left	AR-602-51
	iBalance PFJ Pegged Femoral Trial, size 3, left	AR-602-52
	iBalance PFJ Pegged Femoral Trial, size 4, left	AR-602-53
	iBalance PFJ Pegged Femoral Trial, size 1, right	AR-602-54
	iBalance PFJ Pegged Femoral Trial, size 2, right	AR-602-55
iBalance PFJ Pegged Femoral Trial, size 3, right	AR-602-56	
iBalance PFJ Pegged Femoral Trial, size 4, right	AR-602-57	
12	iBalance PFJ Pegged Drill Stabilizer, size 1	AR-602-38
	iBalance PFJ Pegged Drill Stabilizer, size 2	AR-602-39
	iBalance PFJ Pegged Drill Stabilizer, size 3	AR-602-40
	iBalance PFJ Pegged Drill Stabilizer, size 4	AR-602-41

iBalance® PFJ (Cont.)

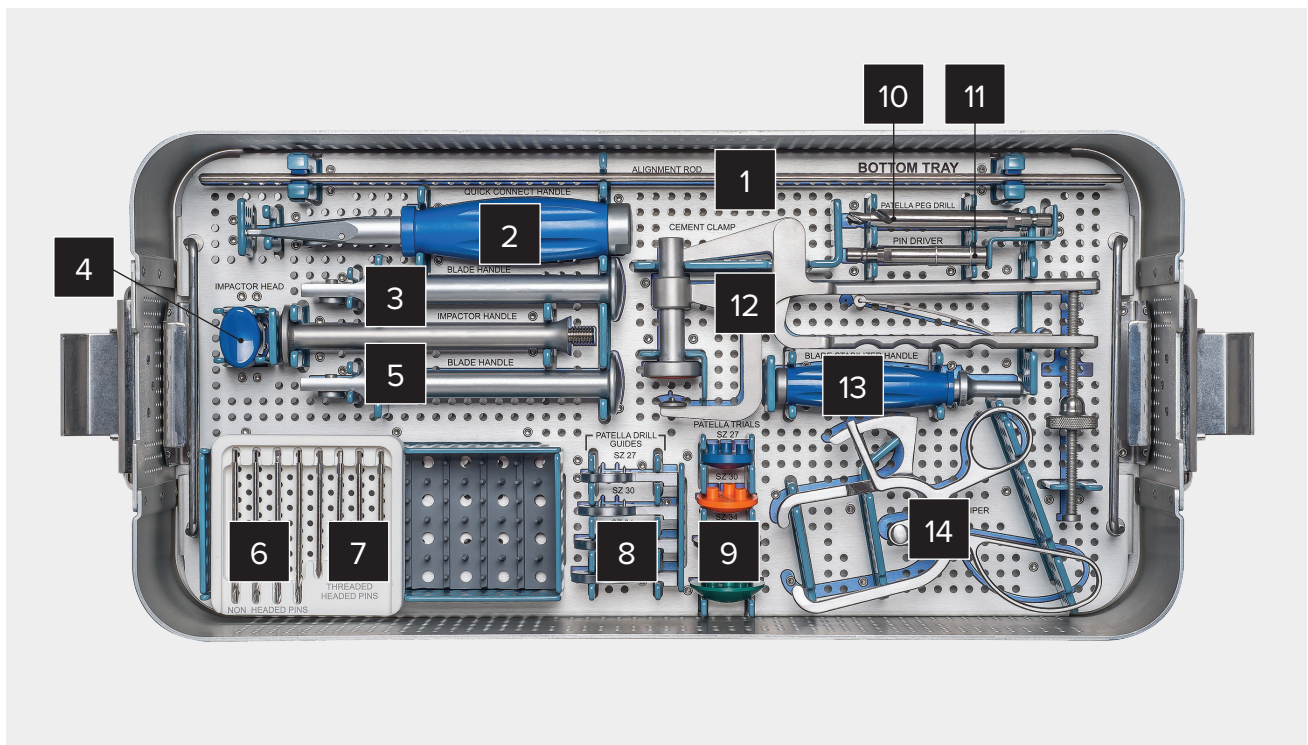

iBalance PFJ, Bottom Tray (AR-602-S)

Label	Product Description	Item Number
1	iBalance UKA Alignment Rod, 3/16 in × 18 in	AR-601-AR00
2	iBalance Handle, quick connect	AR-613-8
3	iBalance PFJ Blade Handle	AR-602-25
4	iBalance PFJ Femoral Impactor Head	AR-602-43
5	iBalance PFJ Universal Impactor Handle	AR-603-31
6	iBalance UKA Fixation Pin, 1/8 in × 3 in	AR-601-FP30
7	iBalance PFJ Threaded Pin, headed	AR-603-72
8	iBalance Patella Drill Guide, 27 mm iBalance Patella Drill Guide, 30 mm iBalance Patella Drill Guide, 34 mm iBalance Patella Drill Guide, 37 mm	AR-602-44 AR-602-45 AR-602-46 AR-602-47
9	iBalance PFJ Dome Patella Trial, size 27, 8 mm thick iBalance PFJ Dome Patella Trial, size 30, 8 mm thick iBalance PFJ Dome Patella Trial, size 34, 9 mm thick iBalance PFJ Dome Patella Trial, size 37, 10 mm thick	AR-603-77 AR-603-79 AR-603-81 AR-603-83
10	Patella Peg Drill	AR-603-92
11	iBalance PFJ Pin Driver	AR-613-91
12	iBalance PFJ Patella Cement Clamp	AR-603-85
13	iBalance PFJ Blade Stabilizer Handler	AR-602-24
14	iBalance Patella Calipers	AR-602-48

Not Pictured

Product Description	Item Number
iBalance PFJ Flexion Anterior Cut Guide	AR-602-58
iBalance PFJ Dome Patella Trial, size 40, 10 mm thick	AR-603-84
iBalance Patella Drill Guide Combo	AR-602-49

Patellar Resection System

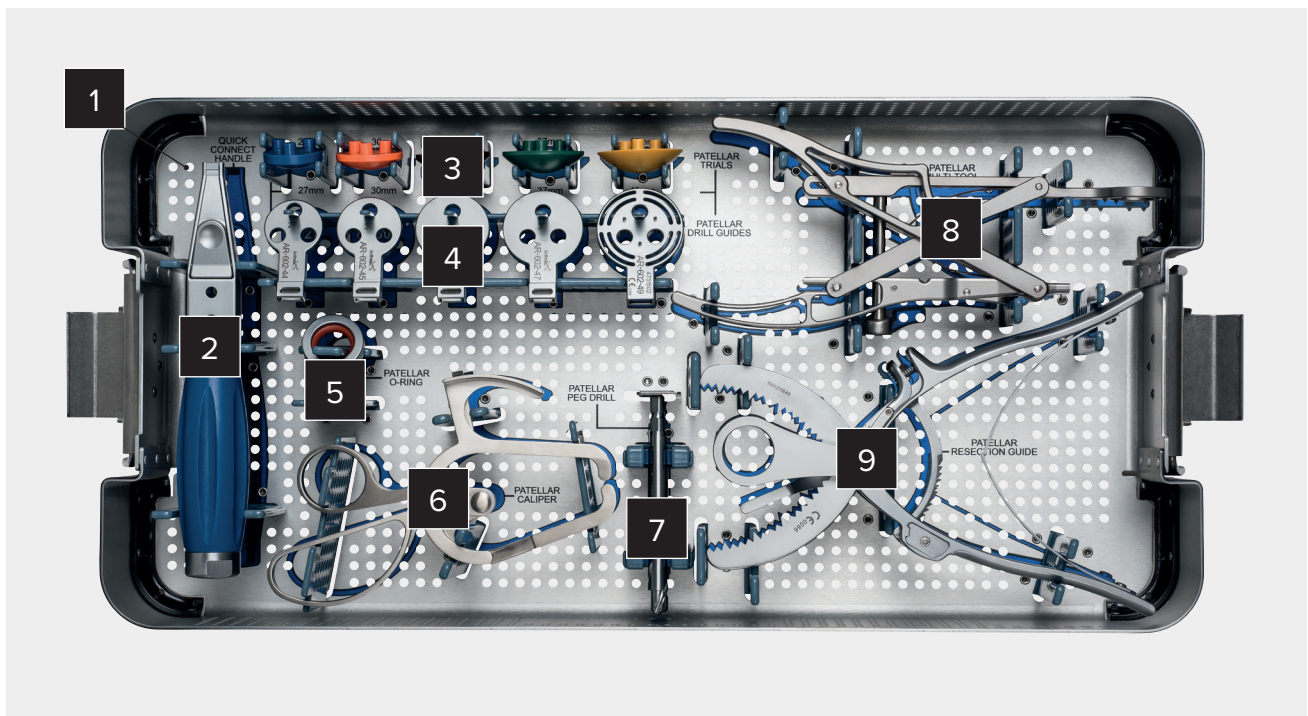

Patellar Resection System (AR-612-S)

Label	Product Description	Item Number
1	Patella Resection Instrument Case	AR-612-C1
2	Quick-Connect Handle	AR-613-8
3	Patella Trial, 34 mm Patella Trial, 34 mm Patella Trial, 34 mm Patella Trial, 37 mm Patella Trial, 40 mm	AR-603-77 AR-603-79 AR-603-81 AR-603-83 AR-603-84
4	Patella Drill Guide, 27 mm Patella Drill Guide, 30 mm Patella Drill Guide, 34 mm Patella Drill Guide, 37 mm Patella Drill Guide, 40 mm	AR-602-44 AR-602-44 AR-602-46 AR-602-47 AR-602-49
5	O-ring Attachment	AR-613-95
6	Patella Calipers	AR-602-48
7	Patella Peg Drill	AR-603-92
8	Patella Multitool	AR-613-93
9	Patella Resection Guide	AR-612-19

Instruments

Patellar Reaming Instrument Set (AR-612-SR)

Product Description	Item Number
Patellar Reamer Instrument Case	AR-612-C2
Patella Reamer Planer Guide, 27 mm	AR-612-4
Patella Reamer Planer Guide, 30 mm	AR-612-5
Patella Reamer Planer Guide, 34 mm	AR-612-6
Patella Reamer Planer Guide, 37 mm	AR-612-7
Patella Reamer Planer Guide, 40 mm	AR-612-8
Patella Reamer Lug Prep, 27 mm	AR-612-14
Patella Reamer Lug Prep, 30 mm	AR-612-15
Patella Reamer Lug Prep, 34 mm	AR-612-16
Patella Reamer Lug Prep, 37 mm	AR-612-17
Patella Reamer Lug Prep, 40 mm	AR-612-18
Patella Reamer Cement Insert	AR-612-3
Patella Peg Drill	AR-603-92
Patella Trial, 27 mm	AR-603-77
Patella Trial, 30 mm	AR-603-79
Patella Trial, 34 mm	AR-603-81
Patella Trial, 37 mm	AR-603-83
Patella Trial, 40 mm	AR-603-84
Patella Reamer Planer, 27 mm	AR-612-9
Patella Reamer Planer, 30 mm	AR-612-10
Patella Reamer Planer, 34 mm	AR-612-11
Patella Reamer Planer, 37 mm	AR-612-12
Patella Reamer Planer, 40 mm	AR-612-13
Patellar Reamer Clamp	AR-612-1
Patella Calipers	AR-602-48
Patellar Drill Guide, 27 mm	AR-602-44
Patellar Drill Guide, 30 mm	AR-602-45
Patellar Drill Guide, 34 mm	AR-602-46
Patellar Drill Guide, 37 mm	AR-602-47
Patellar Drill Guide, 40 mm	AR-602-49
Patella Reamer, planer body	AR-612-2

References

1. Magosch P, Lichtenberg S, Habermeyer P. Survival of stemless humeral head replacement in anatomic shoulder arthroplasty: a prospective study. *J Shoulder Elbow Surg.* 2021;30(7):e343-e355. doi:10.1016/j.jse.2020.09.034
2. Alikhah A, Imiolczyk J, Krukenberg A, Scheibel M. Screw fixation in stemless shoulder arthroplasty for the treatment of primary osteoarthritis leads to less osteolysis when compared to impaction fixation. *BMC Musculoskelet Disord.* 2020;21(1):295. doi:10.1186/s12891-020-03277-3
3. Sites Medical Research and Development. Bone ingrowth performance of OsteoSync™ Ti. Available at: [https:// www.sitesmedical.com/wp-content/uploads/The-Bone-Ingrowth-Performance-of-OsteoSync-Ti.pdf](https://www.sitesmedical.com/wp-content/uploads/The-Bone-Ingrowth-Performance-of-OsteoSync-Ti.pdf)
4. Erickson BJ, Shishani Y, Bishop ME, Romeo AA, Lederman E, Gobeze R. Tuberosity repair in reverse total shoulder arthroplasty for fracture using a stem-based double-row repair: a cadaveric biomechanical study. *J Am Acad Orthop Surg.* 2020;28(23):e1059-1065. doi:10.5435/JAAOS-D-19-0066
5. Arthrex, Inc. Data on file (LA0239). Naples, FL; 2008.
6. Schmalzl J, Jessen M, Holschen M, et al. Tuberosity healing improves functional outcome following primary reverse shoulder arthroplasty for proximal humeral fractures with a 135° prosthesis. *Eur J Orthop Surg Traumatol.* 2020;30(5):909-916. Dot:10.1007/s00590-020-02649-8
7. Arthrex, Inc. Data on file (MyVIP pilot study). Naples, FL; 2021.



This description of technique is provided as an educational tool and clinical aid to assist properly licensed medical professionals in the usage of specific Arthrex products. As part of this professional usage, the medical professional must use their professional judgment in making any final determinations in product usage and technique. In doing so, the medical professional should rely on their own training and experience and should conduct a thorough review of pertinent medical literature and the product's directions for use. Postoperative management is patient-specific and dependent on the treating professional's assessment. Individual results will vary and not all patients will experience the same postoperative activity level or outcomes.

arthrex.com

© 2024-08 Arthrex, Inc. All rights reserved. LB1-000312-en-US_D



Arthrex manufacturer,
authorized representative,
and importer information
(Arthrex eIFUs)



US patent information