

# Orthobiologics

Next Generation in Biologics Technology | 2023

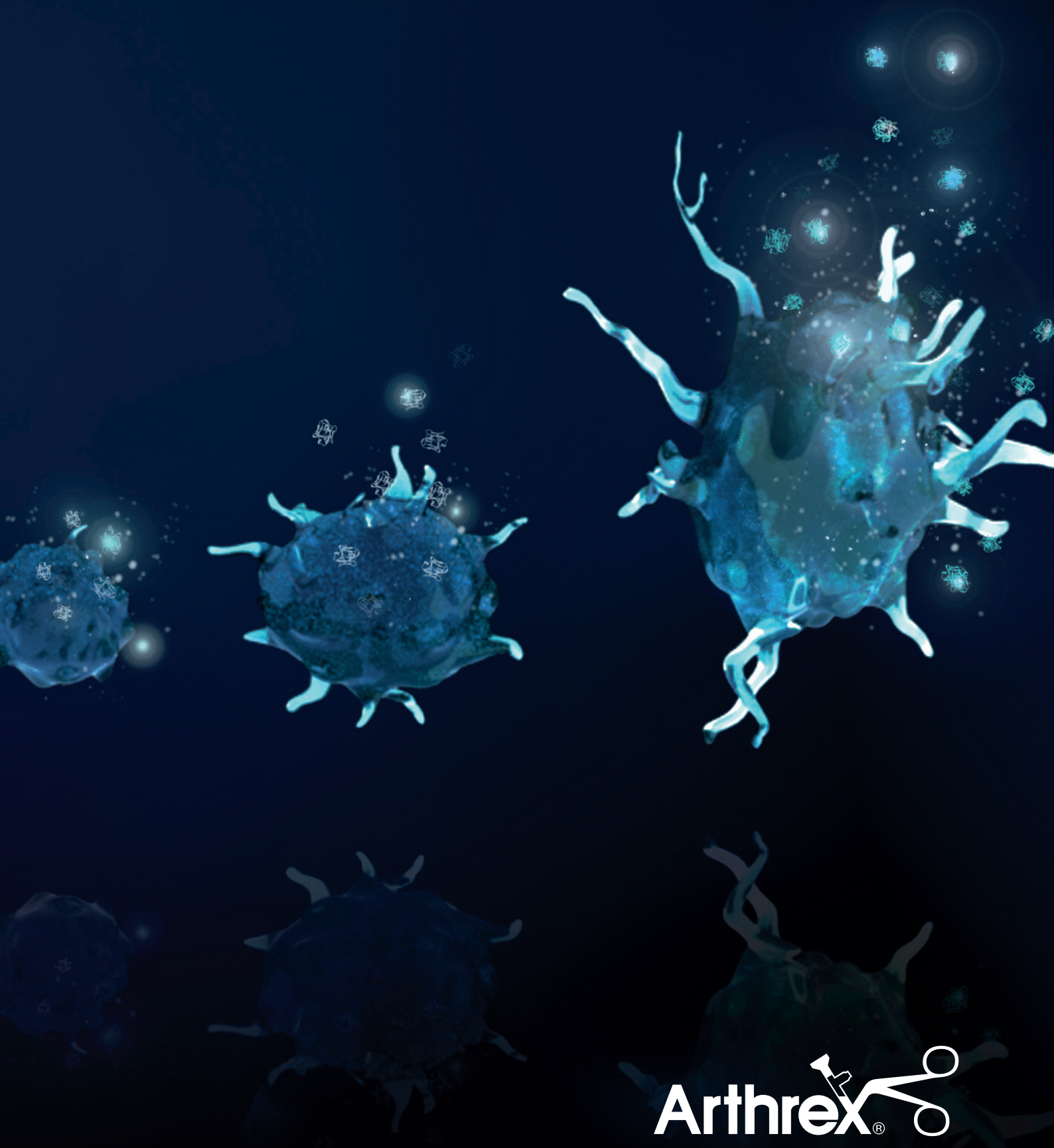

**Arthrex®** 

---

## Helping Surgeons Treat Their Patients Better™

---

Since its inception, Arthrex has been committed to one mission: Helping Surgeons Treat Their Patients Better. We are strategically focused on constant product innovation through scientific research, surgeon collaboration, and medical education to make less invasive surgical procedures simpler, safer, and more reproducible. Each year, we develop more than 1000 new innovative products and procedures to advance minimally invasive orthopedics worldwide.

Arthrex has always remained a privately held company, which allows for the rapid evaluation of new technologies and ideas, and the freedom to develop products and techniques that truly make a difference without economic considerations or compromise. Our experienced team of dedicated professionals represents a shared passion and commitment to delivering uncompromising quality to the health care providers who use our products and the millions of patients whose lives we impact.

The medical significance of our contributions serves as our primary benchmark of success and will continue into the future as the legacy of Arthrex.



---

## Table of Contents

---

Cellular and Molecular Biologics .....	<b>05</b>
Bone Repair .....	<b>19</b>
Cartilage and Meniscus.....	<b>43</b>
Soft Tissue .....	<b>59</b>
Wound Care.....	<b>73</b>
References.....	<b>79</b>



# Cellular and Molecular Biologics

Arthrex ACP® Double-Syringe System.....	06
ACP Max™ Platelet-Rich Plasma.....	07
Angel® cPRP System for PRP Formulation.....	08
Angel cPRP System for Bone Marrow Aspirate Processing.....	09
Bone Marrow Aspiration.....	10
Vortex™ Threaded Recovery Needle With Angel cPRP System .....	11
Viscous Delivery Systems.....	12
Thrombinator™ System for Use With the Angel cPRP System.....	13
AutoPose™ System for Adipose Tissue Harvesting.....	14
AutoPose Infiltration Kit .....	15
SynoJoynt® 1% Sodium Hyaluronate.....	16

## Arthrex ACP® Double-Syringe System

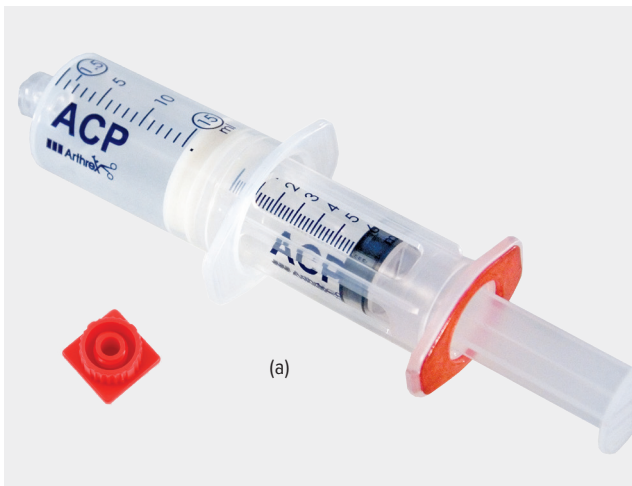

(a)



(b)



(c)

There has been increased interest in autologous blood products for use in a number of orthopedic therapies. The main effects of platelet-rich plasma (PRP) are thought to be caused by growth factors released from the platelets, which may play a beneficial role within these therapies.

- The Arthrex ACP (autologous conditioned plasma) system allows for rapid and efficient concentration of platelets and growth factors from autologous blood for use at the treatment site
- The unique double-syringe design allows for convenient and safe handling, as the whole preparation process takes place in a closed system
- The Arthrex ACP system is affordable, easy to use, and has a quick procedure time when compared to other PRP devices
- White blood cells, specifically neutrophils, are NOT concentrated within the ACP system. These cells can be detrimental to the healing process owing to release of degradative proteins and reactive oxygen species<sup>1,2</sup>

Product Description	Item Number
ACP/Double Syringe w/ Cap (a)	ABS-10010S
Series I ACP Blood Draw Kit (c)	ABS-10011
Series I ACP Kit w/ ACD-A	ABS-1001T
Series II ACP Blood Draw Kit (d)	ABS-10012
Centrifuge, Drucker	00389-129-000K
Bucket	03-1-0001-0097K
Bucket Spacer	03-1-0001-0098K
Counterbalance	ABS-10027
Arthrex Biologics Cart (b) (compatible with both Angel® and ACP centrifuge systems)	ABS-10100



(d)

# ACP Max™ PRP System

The ACP Max system allows for the efficient concentration of platelets from whole blood (WB) volumes of 30 mL, 60 mL, or 90 mL. The system's final output results in a neutrophil-poor PRP solution with up to 12x platelet concentration over baseline.<sup>3-5</sup>

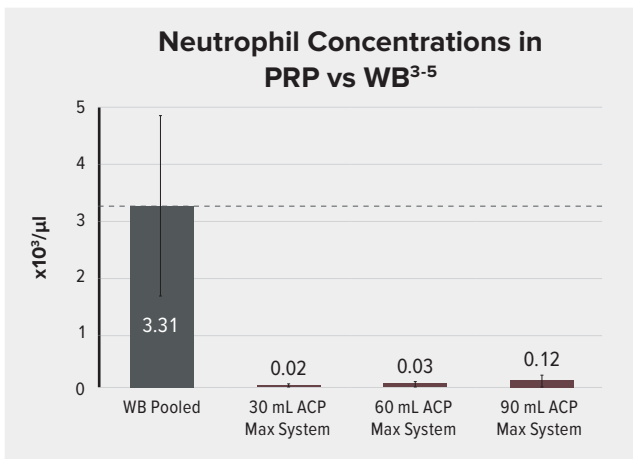
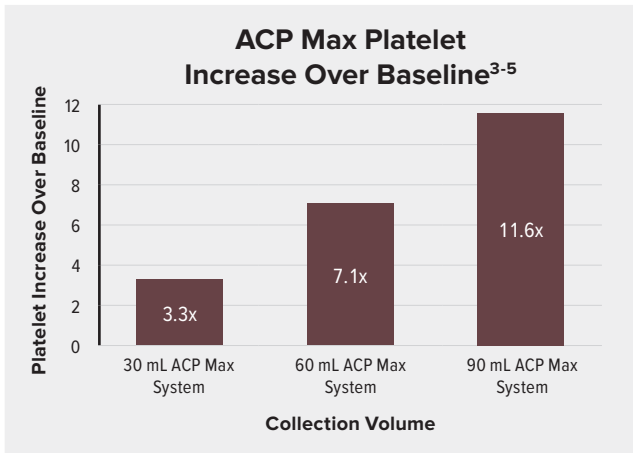

Product Description	Item Number
ACP Max PRP System	ABS-10013
ACP Max PRP System w/ ACD-A	ABS-10015

# ACP MAX™



## Angel® cPRP System for PRP Formulation



What sets the Angel cPRP system apart from the competition is technology. Using a proprietary platelet sensor and one-button automation to prepare customized PRP formulations, the Angel cPRP system can deliver platelet concentrations up to 18× over baseline with adjustable leukocyte concentrations.

- Proprietary platelet sensor system
- Adjustable platelet concentrations
- Adjustable WBC concentrations
- Flexible processing volume, 40 mL to 180 mL
- Each processing kit can process 3 cycles of up to 180 mL on the same patient
- Programmable and capable of storing up to 30 custom processing protocols
- Closed system, delivers PRP, PPP, and RBCs into separate, sterile compartments

Product Description	Item Number
Angel System Centrifuge	ABS-10060
Angel System Centrifuge, refurbished	ABS-10060R
Angel Kit	ABS-10063
Angel PRP Kit	ABS-10061T
Arthrex Biologics Cart	ABS-10100



## Angel® cPRP System for Bone Marrow Aspirate (BMA) Processing



Angel cPRP System for Bone Marrow Processing	Platelet Concentration (K/mL)	Nucleated Cell Concentration (K/mL)	Hematopoietic Cell Concentration (K/mL)	Total Neutrophil ( $\times 10^6$ )
<b>BMA</b>	87.7 $\pm$ 6.4	24.5 $\pm$ 15.6	0.002 $\pm$ 0.001	612.1
<b>PRP concentrate from BMA</b>	787.0 $\pm$ 317.6	240.5 $\pm$ 186.6	0.081 $\pm$ 0.056	132.9
<b>Increase above baseline</b>	$\sim 9\times$	$\sim 10\times$	$\sim 33\times$	$\uparrow 80\%$

Technology is what sets the Angel cPRP system apart from the competition. The Angel cPRP system uses proprietary sensor technology and one-button automation to deliver customized PRP concentrate. The Angel cPRP system is the only device that can provide PRP concentrate from BMA with adjustable cellular levels. Bone marrow is a rich source of platelets, nucleated cells, and progenitor cells.

- Proprietary platelet sensor system
- Adjustable platelet concentrations
- Adjustable WBC concentrations
- Programmable—can store up to 30 custom processing protocols
- Each processing kit can process 3 cycles of up to 180 mL on the same patient
- Flexible processing volume, 40 mL to 180 mL
- Closed system; delivers PRP, PPP, and RBCs into separate, sterile compartments

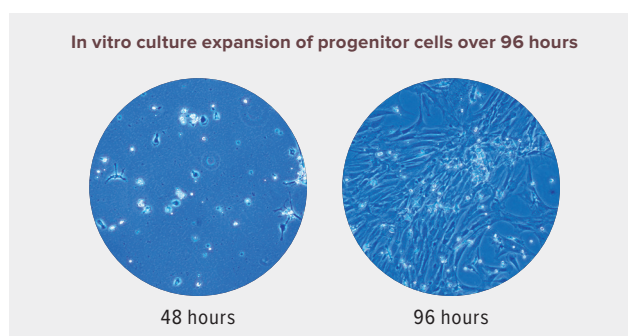

Product Description	Item Number
Angel System Centrifuge <b>(a)</b>	ABS-10060
Angel System Centrifuge, refurbished	ABS-10060R
Angel cPRP System w/ Aspiration Kit (w/ ACD-A) <b>(b)</b>	ABS-10062T
Angel cPRP System w/ Powered Aspiration Kit (w/ ACD-A)	ABS-10062D
Arthrex Biologics Cart	ABS-10100



## Bone Marrow Aspiration

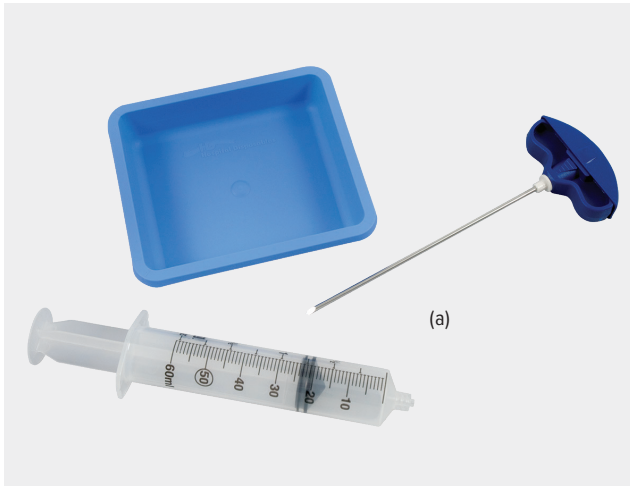

### Bone Aspiration Kit

The Bone Aspiration Kit is a convenient, sterile combination of instruments useful for aspirating bone marrow arthroscopically.

Bone Aspiration Kit (a)

Product Description	Item Number
<ul style="list-style-type: none"> <li>■ 1 Bone Marrow Aspiration Needle</li> <li>■ 1 Syringe, 60 mL</li> <li>■ 1 Prep Tray</li> </ul>	AR-1101DS

Bone marrow-stimulating techniques, like abrasion and microfracturing, have been advocated for over 20 years.<sup>6</sup> Bone marrow is a source of stem cells and progenitor cells that differentiate into a variety of tissues (eg, bone, cartilage, tendon, ligament, fat, muscle, nerve). There has also been discussion that bone marrow stem cells have a role in the maintenance and repair of several other tissues.<sup>7</sup> Because of the plasticity exhibited by bone marrow, a number of studies have investigated the benefits of bone marrow used:

- Through microfracturing into a collagen matrix for treatment of osteochondral defects<sup>7</sup>
- With grafts to treat tibial nonunions<sup>8,9</sup>
- For tendon graft-to-bone interface in rabbit models at early time points<sup>10,11</sup>
- For spinal fusion in a rabbit model<sup>12</sup>
- With growth factors for the treatment of large bony defects in animals<sup>13</sup>
- With porous ceramic scaffolds implanted in human femoral defects with positive results<sup>13</sup>

Bone marrow aspirate (BMA) provides a cell suspension that can be readily processed intraoperatively for immediate implantation. BMA is commonly withdrawn from the iliac crest, but it can also be aspirated from the femur and humerus. BMA can be injected directly to a repair site, localizing a specific volume of BMA to support and facilitate healing.

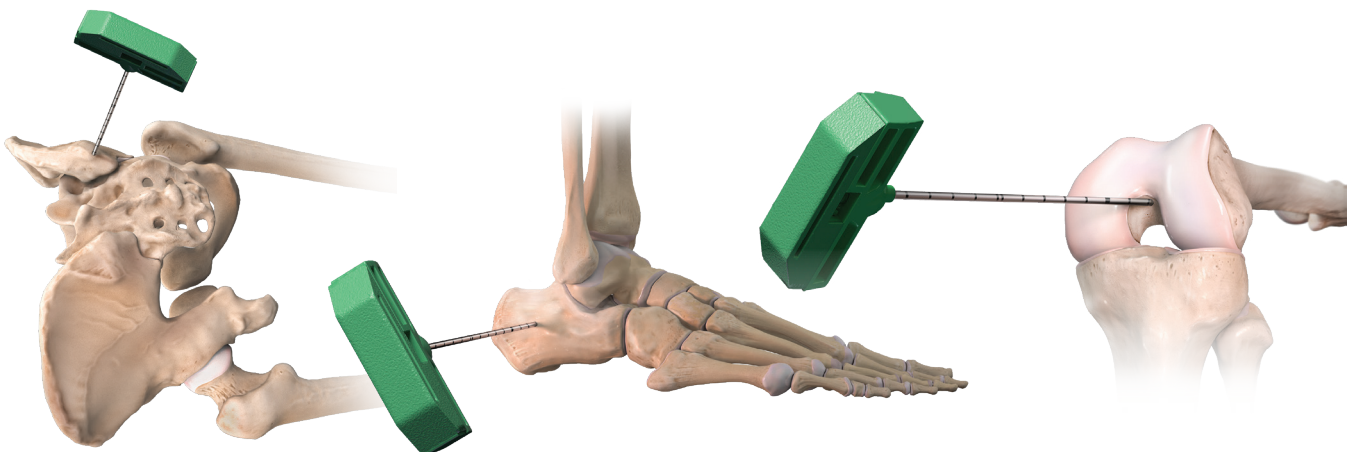

## Vortex™ Threaded Recovery Needle With Angel® cPRP System

Product Description	Item Number
Vortex Threaded Recovery Needle	
Threaded BMA Needle, 8 ga, closed tip	AR-1101TH-8CT
Threaded BMA Needle, 8 ga, open tip	AR-1101TH-8OT
Threaded BMA Needle, 13 ga, closed tip	AR-1101TH-13CT
Threaded BMA Needle, 13 ga, open tip	AR-1101TH-13OT
Vortex Threaded Recovery Needle Kit	AR-1101THK-8
<ul style="list-style-type: none"> <li>■ Vortex Threaded Recovery Needle, 8 ga, open tip</li> <li>■ Prep Tray</li> <li>■ Syringe</li> </ul>	
Vortex Threaded Recovery Needle Kit	AR-1101THK-13
<ul style="list-style-type: none"> <li>■ Vortex Threaded Recovery Needle, 13 ga, open tip</li> <li>■ Prep Tray</li> <li>■ Syringe</li> </ul>	
Vortex Needle Power Adapter	AR-1001-TH-PWR
DrillSaw Sports 400™ Power System	
Handpiece	AR-400
Lithium-ion Battery Housing, for AR-400	AR-400UBH-1
Aseptic Transfer Kit, for AR-400	AR-400ATK-1
Battery Pack, for AR-400, nonsterile	AR-400UB
Reamer Attachment, Hudson style	AR-400RZH
Angel System	
Angel BMA Processing Kit, 8 ga, closed tip, w/o ACD-A	ABS-10062-TH8CT
Angel BMA Processing Kit, 8 ga, open tip, w/o ACD-A	ABS-10062-TH8OT
Angel BMA Processing Kit, 13 ga, closed tip, w/o ACD-A	ABS-10062-TH13CT
Angel BMA Processing Kit, 13 ga, open tip, w/o ACD-A	ABS-10062-TH13OT
Angel BMA Processing Kit w/ Vortex Threaded Recovery Needle, 8 ga, closed tip, w/ ACD-A	ABS-10062K-TH8CTA
Angel BMA Processing Kit w/ Vortex Threaded Recovery Needle, 8 ga, open tip, w/ ACD-A	ABS-10062K-TH8OTA
Angel BMA Processing Kit w/ Vortex Threaded Recovery Needle, 13 ga, closed tip, w/ ACD-A	ABS-10062K-TH13CTA
Angel BMA Processing Kit w/ Vortex Threaded Recovery Needle, 13 ga, open tip, w/ ACD-A	ABS-10062K-TH13OTA
Angel BMA Processing Kit w/ Vortex Threaded Recovery Needle, 8 ga, closed tip, w/o ACD-A	ABS-10062K-TH8CT
Angel BMA Processing Kit w/ Vortex Threaded Recovery Needle, 8 ga, open tip, w/o ACD-A	ABS-10062K-TH8OT
Angel BMA Processing Kit w/ Vortex Threaded Recovery Needle, 13 ga, closed tip, w/o ACD-A	ABS-10062K-TH13CT
Angel BMA Processing Kit w/ Vortex Threaded Recovery Needle, 13 ga, open tip, w/o ACD-A	ABS-10062K-TH13OT
Angel System Centrifuge	ABS-10060
Angel System Centrifuge, refurbished	ABS-10060R
Arthrex Biologics Cart	ABS-10100

The Vortex threaded recovery needle features a unique design that facilitates precise depth and directional control, allowing the user to reposition the tip of the needle easily and accurately within the bone, to optimize bone marrow aspiration. Studies have shown that the first 2 cc of aspiration for any one depth and location have the highest concentration of osteoprogenitor cells.<sup>14</sup>

The Vortex needle can be ordered with the Arthrex Angel cPRP processing kit for efficient aspiration from a wide array of orthopedic and spine applications such as a vertebral body, the anterior superior iliac spine (ASIS), the posterior superior iliac spine (PSIS), the calcaneus, the femur, and the humerus.

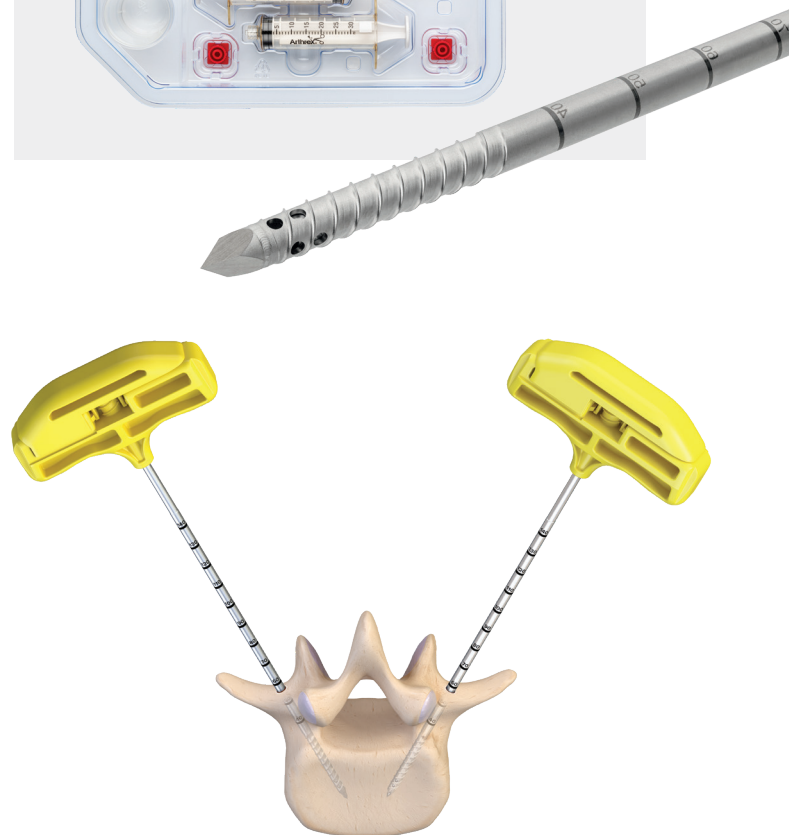
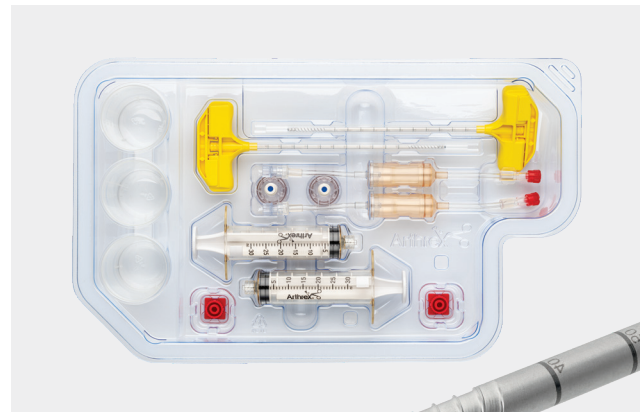

**VORTEX**  
Threaded Bone Marrow Recovery Needle

ARTHREX  
**angel**  
SYSTEM



## Viscous Delivery Systems

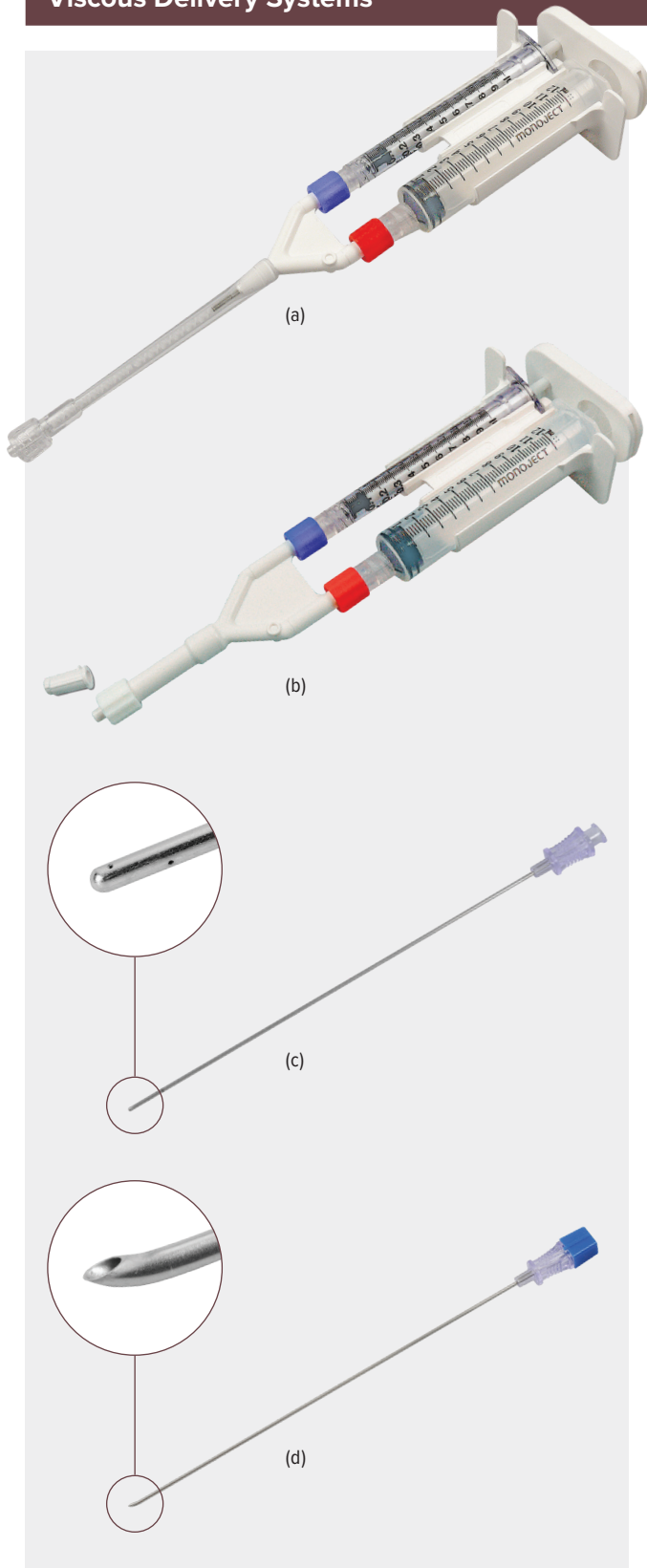

- Quick and simple to attach and detach
- Easy to fill—no need to disassemble
- 11:1 ratio allows homologous mixture of 2 fluids
- Use to provide a low- or high-viscosity fluid
- ACP/PRP can be mixed with allograft or autograft bone prior to application to an orthopedic surgical site as a spray, gel, or clot
- Extra long, blunt, fenestrated, and beveled delivery needles

Product Description	Item Number
Viscous-Gel Applicator, high-viscosity <b>(a)</b>	ABS-10050
Viscous-Spray Applicator, low-viscosity <b>(b)</b>	ABS-10051
Viscous-Spray II Applicator, low-viscosity	ABS-10052
Fenestrated Delivery Needle <b>(c)</b>	ABS-20000
Tuohy Delivery Needle <b>(d)</b>	ABS-21000
Cannula Bending Tool	AR-6650
Ratio Applicator Assembly, 11:1 ratio	SA-1001
Applicator w/ Dual Spray Tips, 11:1 ratio	SA-1060
6 ga × 10 cm (4 in)	SA-3600
20 ga × 5 cm (2 in)	SA-3615
20 ga × 10 cm (4 in)	SA-3618
20 ga × 18 cm (7 in)	SA-3619
20 ga × 26 cm (10.25 in)	SA-3620
Dual Cannula Semiflexible Endoscopic, 32 cm	SA-3650
Dual Spray Tip	SA-3660
Endoscopic Applicator w/ Mixing Tip, 30 cm, 1:1 ratio	SA-3662
Blending Connector w/ Single Flexible Cannula	SA-3673
Blending Connector w/ Single Spray	SA-3674
Mixing Applicator, low viscosity, w/ spray tip	SA-3675
Applicator Procedure Kit, 11:1 ratio	SA-4400
Dual Spray Procedure Kit, 11:1 ratio	SA-4460
Gas Assisted Procedure Kit, 11:1 ratio	SA-6111
Applicator Assembly, 3 cc, 1:1 ratio	SA-3303



## Thrombinator™ System for Use With the Angel® cPRP System

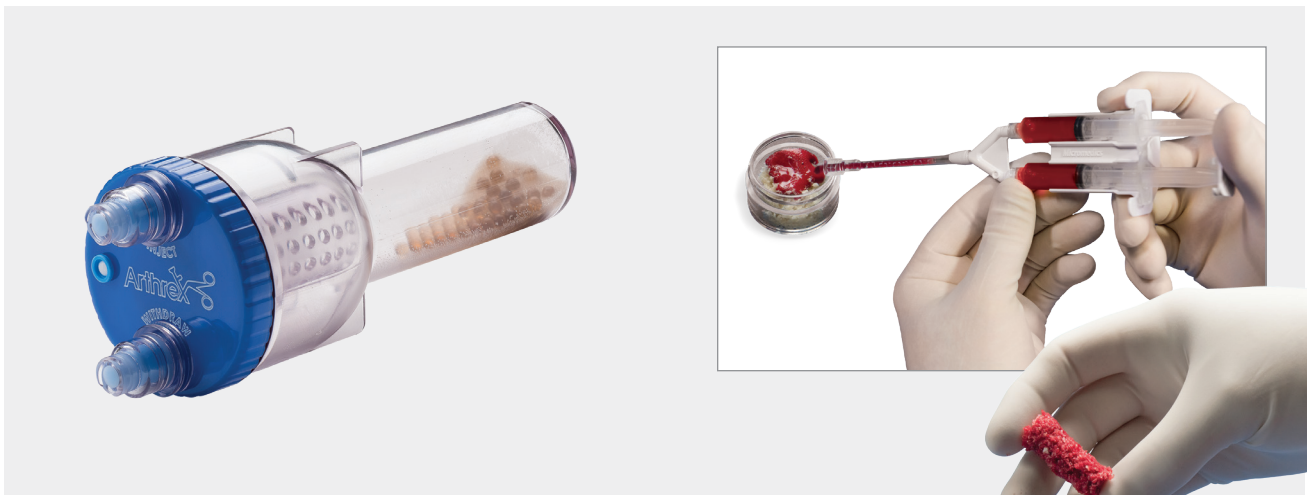

The Thrombinator system for use with the Angel concentrated platelet-rich plasma (cPRP) system is designed to produce an autologous activation serum at the point of care. The serum produced by the Thrombinator system can be used to improve the handling of bone grafts hydrated with cPRP. Autologous activation serum improves handling by activating platelets to produce a gel that serves as a binding agent for bone graft material. The Thrombinator process uses the principles of the clotting cascade to produce an activation serum without the use of harsh chemical reagents such as ethanol. The Thrombinator design eliminates the need for lengthy incubation times and heating requirements. Autologous activation serum can be produced in less than 20 minutes from peripheral (whole) blood or platelet-poor plasma at the point of care.

- Rapid preparation, less than 20 minutes
- Prepare from WB or platelet-poor plasma (PPP)
- Produces clot in as little as 15 seconds
- Centrifugation not required

Product Description	Item Number
Thrombinator System for Use With the Angel cPRP System	ABS-10080
Angel System Centrifuge	ABS-10060

### Accessories

Product Description	Item Number
Dual Cannula Semiflexible Endoscopic, 32 cm	SA-3650
Dual Spray Tip	SA-3660
Endoscopic Applicator w/ Mixing Tip, 30 cm, 1:1 ratio	SA-3662
Blending Connector w/ Single Flexible Cannula	SA-3673
Blending Connector w/ Single Spray	SA-3674
Mixing Applicator Low Viscosity w/ Spray Tip	SA-3675
Blending Connector w/ Mixer	SA-3678



## AutoPose™ System for Adipose Tissue Harvesting

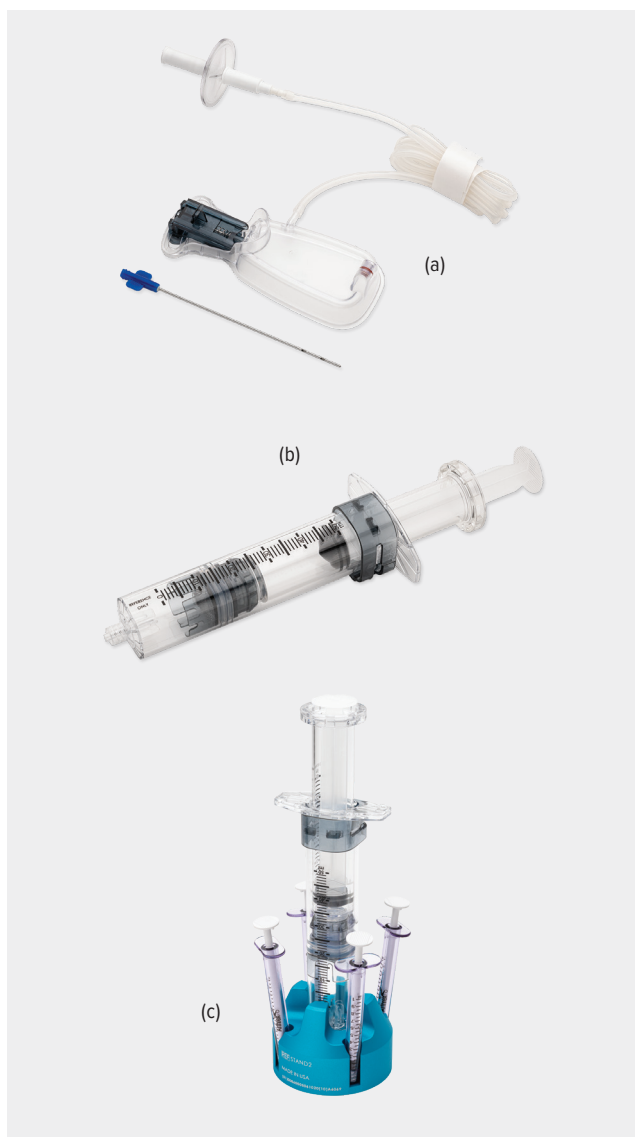

The AutoPose system provides for safe and rapid preparation of autologous micro-fragmented adipose tissue (MFAT) for injection. AutoPose Access assists with harvesting of adipose tissue, while the dual-chamber AutoPose Restore syringe is used to aspirate, concentrate, and resize. The resulting washed autologous MFAT provides cushioning and support to facilitate natural healing of damaged or injured tissues.

Product Description	Item Number
AutoPose Access (a)	ABS-101024-1
AutoPose Restore Syringe (b)	ABS-101035-1
AutoPose Syringe Stand (c)	101-034-02

### Features and Benefits:

#### AutoPose Access

AutoPose Access is a sterile, single-use device that guides the safe harvest of autologous adipose tissue. The Access device utilizes a sterile vacuum cavity to lift and immobilize the dermis. A retractable piercing needle facilitates introduction of the AutoPose Restore dual-syringe cannula used to harvest tissue.

- Vacuum regulator eliminates the need to control vacuum pressure
- Minimally invasive piercing needle eliminates the need for an incision or suture
- Ensures uniform introduction of harvesting cannula through immobilized dermis at a depth of 1 cm
- Articulating arm guides tissue harvest

#### AutoPose Restore Syringe

The AutoPose Restore dual-chamber syringe is a sterile, single-use syringe intended for harvesting, concentrating, and transferring resized adipose tissue. The Restore syringe can be used alone or in conjunction with the AutoPose Access device to harvest a sample of adipose tissue.

- Dual-chamber syringe enables harvesting, purification, and microsizing of fat within a closed system, minimizing risk of environmental contaminants
- Harvesting cannula compatible with piercing needle of the AutoPose Access for controlled harvesting of adipose tissue 1 cm below the skin surface
- Vacuum-lock syringe assists with tissue harvest
- Adipose resized through an 800 micron filter is suitable for delivery through 18- to 21-ga injectors
- Gentle processing preserves viability of the graft tissue

#### AutoPose Restore Syringe Stand

The AutoPose Restore syringe stand is used along with the AutoPose Restore dual-chamber syringe for concentrating, washing, and transferring of autologous fat tissue.

- Reusable
- Can be sterilized with steam or a germicide
- Accommodates both the AutoPose Restore syringe and up to four injection syringes
- Holds the AutoPose Restore syringe in a fixed position during decantation and microsizing



## AutoPose™ Infiltration Kit

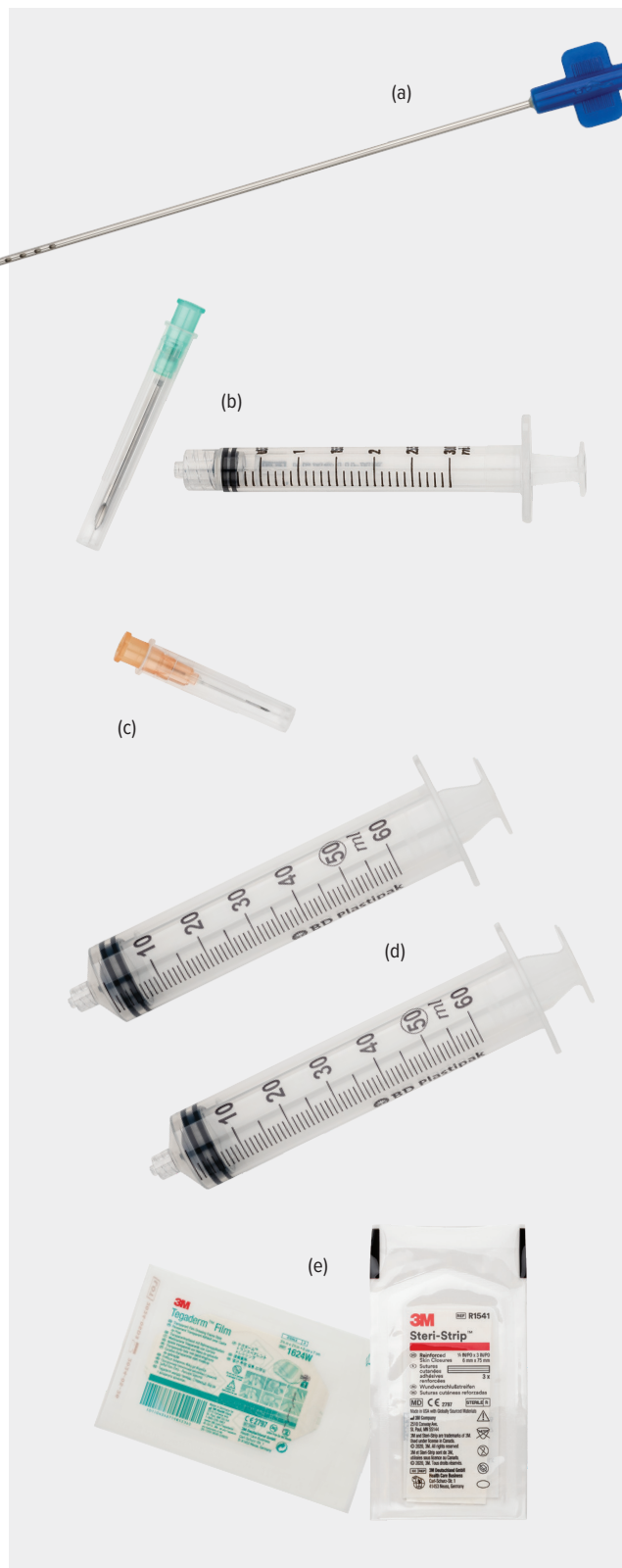

The AutoPose infiltration kit contains all necessary items to facilitate the infiltration step, including:

- Infiltration cannula **(a)**
- 3 cc syringe and 25 ga needle to introduce local anesthetic **(b)**
- 14 ga × 40 mm piercing needle to rapidly access the tissue harvest site **(c)**
- Two 60 mL syringes to facilitate infiltration of tissue **(d)**
- One package each of Steri-Strip™ and Tegaderm™ dressing **(e)**

Product Description	Item Number
AutoPose Infiltration Kit	PACK001-BI
Adipose Tissue Harvesting Kit	ABS-10055

## SynoJoynt® 1% Sodium Hyaluronate

### Key Features

- Non-avian source
- Non-cross-linked
- Stable molecular weight of 2.5 million Da
- Unique J code: J7331

In a 6 month clinical trial, SynoJoynt 1% sodium hyaluronate demonstrated statistically significant decreases in WOMAC pain scores, demonstrating superiority to the placebo and a safety profile similar to saline and Euflexxa® 1% sodium hyaluronate.<sup>15</sup> SynoJoynt 1% sodium hyaluronate has proven excellent safety, tolerability, and pain relief in a 3-dose regimen.<sup>15</sup>

Product Description	Item Number
SynoJoynt 1% Sodium Hyaluronate	82197-0721-16

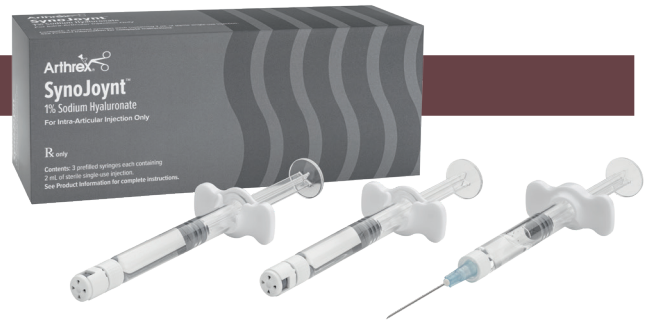
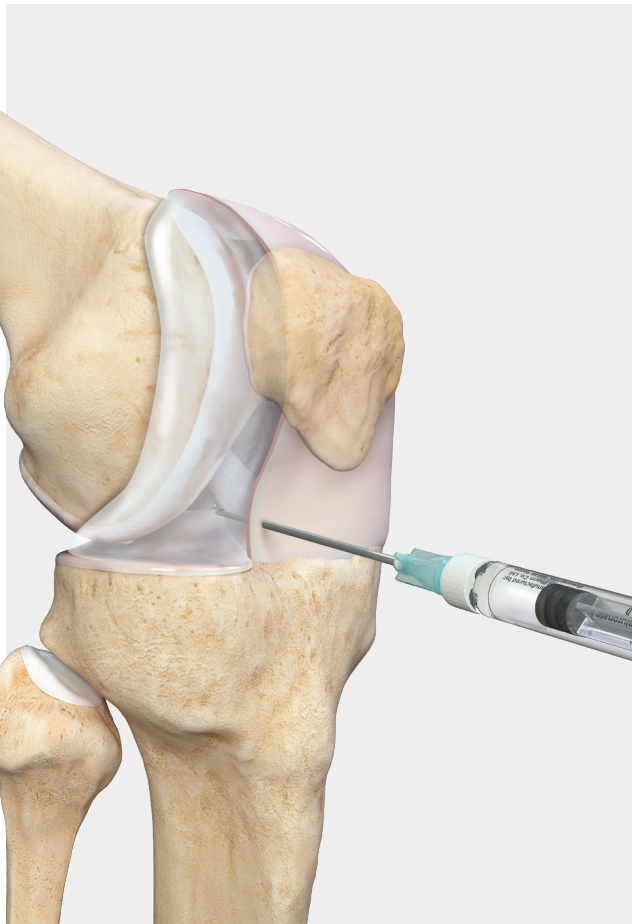

### Indications

SynoJoynt is indicated for the treatment of pain in osteoarthritis (OA) of the knee in patients who have failed to respond adequately to conservative nonpharmacologic therapy and simple analgesics (eg, acetaminophen).

### Contraindications

- Do not use SynoJoynt treatment to treat patients who have a known hypersensitivity to hyaluronan preparations
- Do not use to treat patients with knee joint infections or to treat patients with infections or skin disease in the area of the injection site

### Warnings

- Do not concomitantly use disinfectants containing quaternary ammonium salts or chlorhexidine for skin preparations because hyaluronan can precipitate in their presence
- Do not inject intravascularly because intravascular injections of SynoJoynt treatment may cause systemic adverse events



Euflexxa is a registered trademark of Ferring Pharmaceuticals.







# Bone Repair

ArthroCell™ Viable Bone Matrix.....	20
ArthroCell Plus™ Viable Bone Matrix.....	21
AlloSync™ Expand.....	22
AlloSync Pure Demineralized Bone Matrix.....	23
AlloSync Putty, Gel, and Paste.....	24
BioXpress™ Graft Delivery Device.....	25
AlloSync Button.....	26
AlloSync Demineralized Cancellous Sponges, Chips, and Cortical Fibers...	27
BioSurge™ Cell and Bone Graft Processing System.....	28
AlloSync Cancellous Chips, Cubes, and Cancellous Crush.....	28
AlloSync Cotton and Evans Wedges.....	29
AlloSync Bone PIP Dart for Hammertoe Arthrodesis.....	30
StimuBlast® Demineralized Bone Matrix.....	31
Cannulated Revision Bone Dowels.....	32
Bone Dowel Revision Kit.....	33
BoneSync™ BioActive Matrix.....	34
BoneSync Putty and Strips.....	35
BoneSync Fast-Setting, Drillable Calcium Phosphate Cement.....	36
Quickset™ Calcium Phosphate Cement.....	37
OSferion Wedges.....	38
OsteoAuger™ Bone Graft Harvesting System.....	39
GraftNet™ Autologous Tissue Collector for Bone.....	40



## Viable Bone Matrix

ArthroCell viable bone allograft contains cellular, scaffold, and gel components derived from human bone. The cellular component consists of mesenchymal stem cells, osteoprogenitor cells, and pluripotent cells.

- A safe/nonimmunogenic viable allogenic bone matrix intended for use as a bone void filler for bone defects, fusions, and nonunion orthopedic applications
- Osteogenic, osteoconductive, and osteoinductive potential
- Final product is moldable for ease of use and optimal handling
- Novel cryoprotectant (DMSO-free) and noncytotoxic
- Convenient—can be stored in a cryogenic freezer (-65° C) for up to 2 years

Product Description	Item Number
ArthroCell Viable Bone Matrix, 2.5 cc	ABS-2009-02
ArthroCell Viable Bone Matrix, 5 cc	ABS-2009-05
Mixing Delivery Syringe, 14 cc	ABS-2000



## ArthroCell Plus™ Viable Bone Matrix

ArthroCell Plus is a next-generation viable bone graft that extends our current offerings. ArthroCell Plus allograft is delivered in a premixed syringe, with size offerings of 1 cc, 2.5 cc, 5 cc, and 10 cc. In addition to its composition, ArthroCell Plus grafts contain the same novel cryoprotectant as our current ArthroCell graft offering, providing a product with minimal preparation time.

- Osteogenic, osteoconductive, and osteoinductive potential
- Final product is moldable for ease of use and optimal handling
- Novel cryoprotectant (DMSO-free) and noncytotoxic
- Convenient—can be stored in a cryogenic freezer (-65 °C) for up to 2 years

Product Description	Item Number
ArthroCell Plus Allograft, 1 cc	ABS-2090-01
ArthroCell Plus Allograft, 2.5 cc	ABS-2090-02
ArthroCell Plus Allograft, 5 cc	ABS-2090-05
ArthroCell Plus Allograft, 10 cc	ABS-2090-10





The unique geometry of AlloSync Expand 100% demineralized bone is ideal for intraoperative handling and controlled expansion into bone voids. AlloSync Expand fibers come preloaded in a syringe that allows for consistent hydration of the graft with biologic fluids, such as BMA.

**100% Demineralized Bone Fibers**

- No added fillers for maximum demineralized bone content and osteoinductive potential
- Specific fiber geometry provides exceptional handling and controlled expansion
- Lyophilized fibers extend shelf life while preserving the osteoinductive potential

**Expands to Fill Gaps**

- Wicks blood, bone marrow, and other physiological fluids that allow the graft to expand and improve fill

**Cellular Highways**

- Fibers have demonstrated superior bone-forming capacity compared to standard particulate demineralized bone marrow<sup>16</sup>
- Entangled fibers create a 3D interconnected matrix that can promote cell migration and fusion

**Simplicity of Hydration**

- Luer lock portal delivers a simple yet thorough hydration process
- Flexibility to select various hydration fluids

Product Description	Item Number
AlloSync Expand Fibers, 1 cc	ABS-2017-01
AlloSync Expand Fibers, 2.5 cc	ABS-2017-02
AlloSync Expand Fibers, 5 cc	ABS-2017-05
AlloSync Expand Fibers, 10 cc	ABS-2017-10





## AlloSync™ Pure Demineralized Bone Matrix

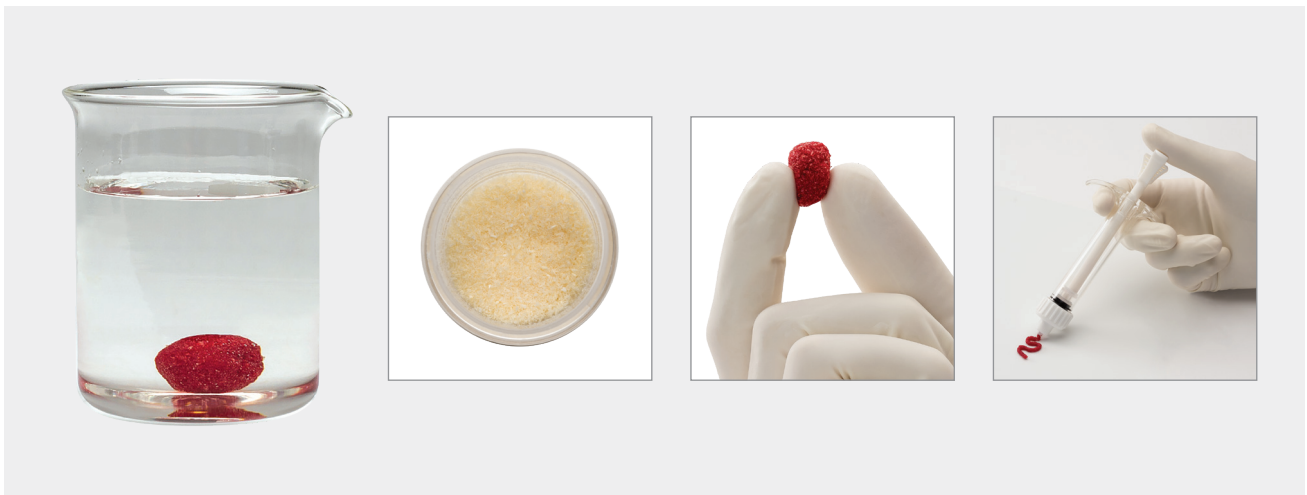

AlloSync Pure osteoinductive demineralized bone matrix is derived from 100% human allograft bone with no extrinsic carriers. When prepared, AlloSync Pure resists irrigation and can be used in a fluid environment. The clinician can control the handling properties of AlloSync Pure bone matrix, which includes decreasing the viscosity for injectable applications or increasing the viscosity to add autograft and/or allograft. The proprietary rice-shape fiber technology used to process AlloSync Pure bone matrix increases the osteoinduction and osteoconductive surface area to accelerate cellular ingrowth.

- Derived from 100% human allograft bone without any extrinsic carriers
- Post-sterilization, every lot is tested in vivo to ensure osteoinductivity
- Demineralization process preserves native bone morphogenetic proteins (BMPs) and growth factors
- Resists irrigation

- Histologically proven to contain all 5 elements of bone formation, including new bone, bone marrow, osteocytes, chondrocytes, and cartilage postimplantation at 28 days<sup>16</sup>
- May be hydrated with bone marrow concentrate (BMC), platelet-rich plasma (PRP), blood, saline, or other cellular components
- Sterile to device grade standards ( $10^{-6}$ ) and stored at ambient temperature
- Provided in a ready-to-use mixing jar
- 4 sizes available
- 5-year shelf life

Product Description	Item Number
AlloSync Pure, 1 cc	ABS-2010-01
AlloSync Pure, 2.5 cc	ABS-2010-02
AlloSync Pure, 5 cc	ABS-2010-05
AlloSync Pure, 10 cc	ABS-2010-10

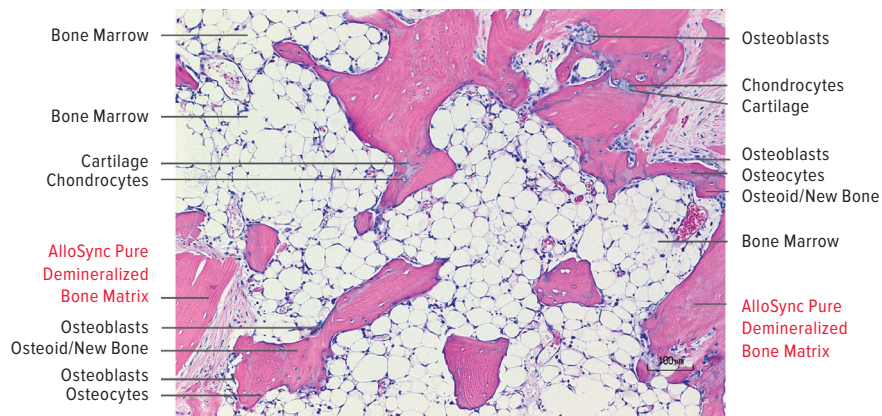

AlloSync Pure demineralized bone matrix histology

# ALLOSYNC PURE

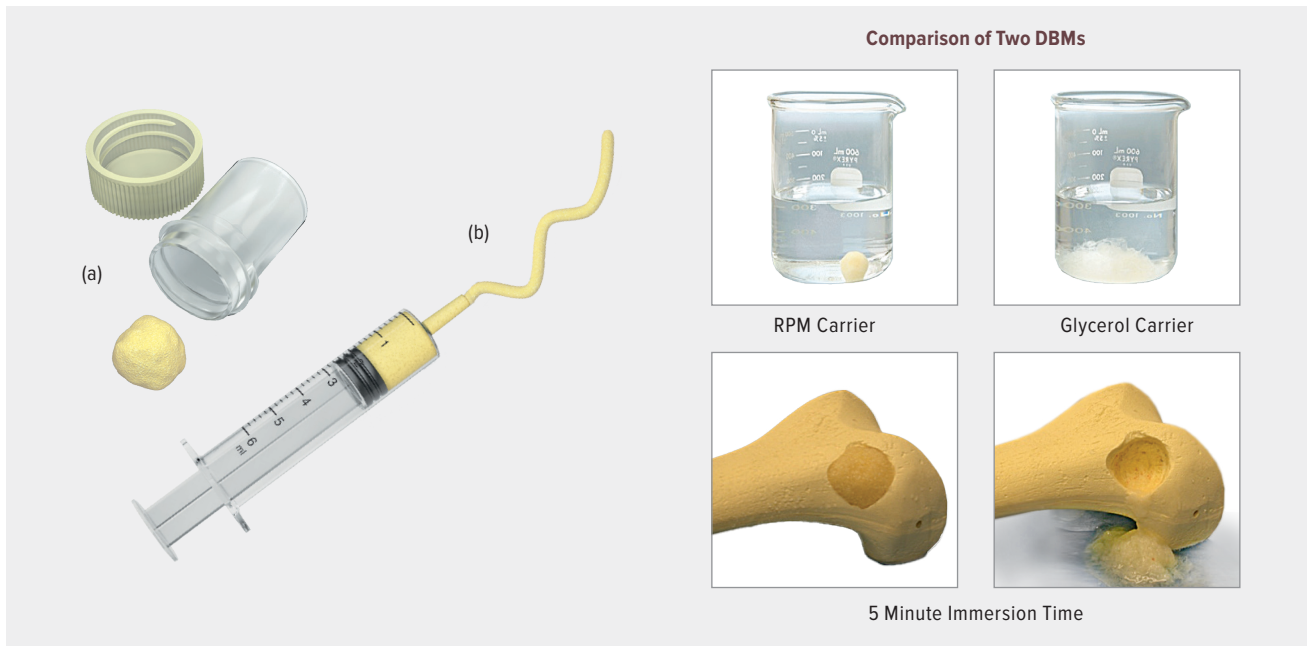

**AlloSync Bone Products May Provide Osteoinductive and Osteoconductive Properties**

- Osteoinduction—signaling molecules such as bone morphogenetic proteins (BMPs) that aid in cell differentiation down osteoblastic pathways
- Every lot of DBM is tested for osteoinductive potential, using either an in vitro assay or in vivo model
- Osteoconduction—scaffolding from DBM particles for osteoblasts to form new bone
- Additional scaffolding properties are provided in AlloSync cancellous bone with the addition of cancellous bone chips

**Superior Handling Characteristics via the Reverse-Phase Medium (RPM) Carrier**

- RPM is an inert, biocompatible copolymer consisting of polypropylene oxide and polyethylene oxide
- Material is flowable at room temperature and thickens to become more viscous at body temperature
- RPM allows the DBM graft to be moldable and packed into any defect size or shape
- AlloSync bone products will resist irrigation and can be used in a fluid environment without the fear of graft migration, unlike some other DBMs

**AlloSync Bone Products Offer Ease of Use and Terminal Sterility**

- Provided as a ready-to-use, off-the-shelf product that requires no thawing or premixing preparation
- Terminal sterilization using electron beam results in a sterility assurance level (SAL) of 10<sup>-6</sup>; process is not harmful to the DBM or its bioactivity
- Room temperature storage

Product Description	Item Number
<b>AlloSync DBM Putty</b>	
Putty, 1 cc (a)	ABS-2012-01
Putty, 2.55 cc	ABS-2012-02
Putty, 5 cc	ABS-2012-05
Putty, 10 cc	ABS-2012-10
<b>AlloSync DBM Gel</b>	
Gel, 1 cc (b)	ABS-2013-01
Gel, 5 cc	ABS-2013-05
Gel, 10 cc	ABS-2013-10
<b>AlloSync CB DBM Putty</b>	
Putty, 5 cc	ABS-2014-05
Putty, 10 cc	ABS-2014-10
<b>AlloSync CB DBM Paste</b>	
Paste, 1 cc	ABS-2015-01
Paste, 3 cc	ABS-2015-03
Paste, 8 cc	ABS-2015-08

## BioXpress™ Graft Delivery Device

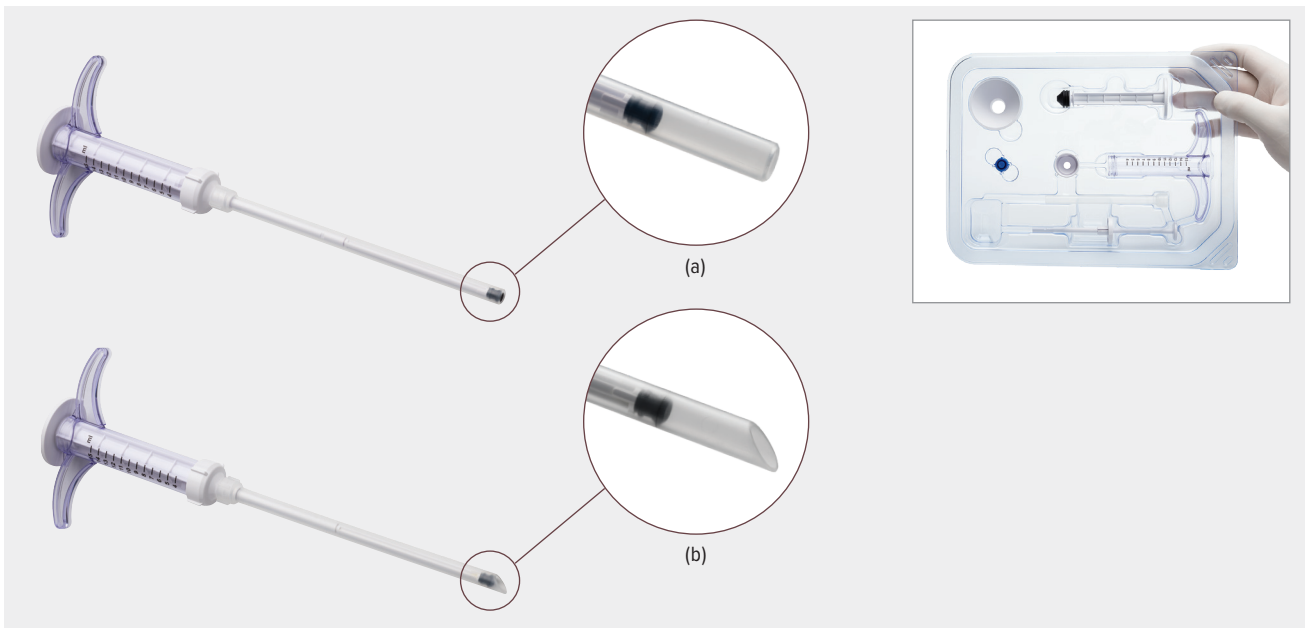

The BioXpress graft delivery device is designed for targeted delivery of hydrated allograft, autograft, or synthetic bone graft materials to an orthopedic surgical site, while maximizing material use.

Product Description	Item Number
Blunt Tip Cannula, 10 cm <b>(a)</b>	ABS-10053-10
Angled Tip Cannula, 10 cm <b>(b)</b>	ABS-10053-10-45
Blunt Tip Cannula, 15 cm	ABS-10053-15
Angled Tip Cannula, 15 cm	ABS-10053-15-45



## AlloSync™ Button



The AlloSync button is a 12 mm round by 3 mm thick demineralized cancellous bone disc. This disc maintains the same superior handling characteristics as the AlloSync demineralized cancellous sponges. The compressible nature of this graft allows it to be delivered to a repair site through an arthroscopic portal.

Product Description	Item Number
AlloSync Button, 12 mm × 3 mm	ABS-2011

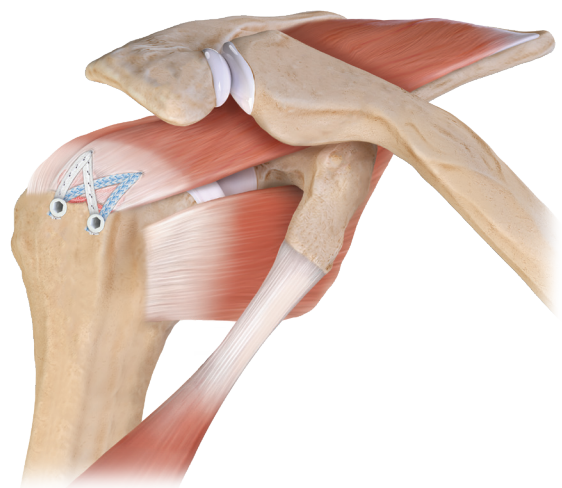
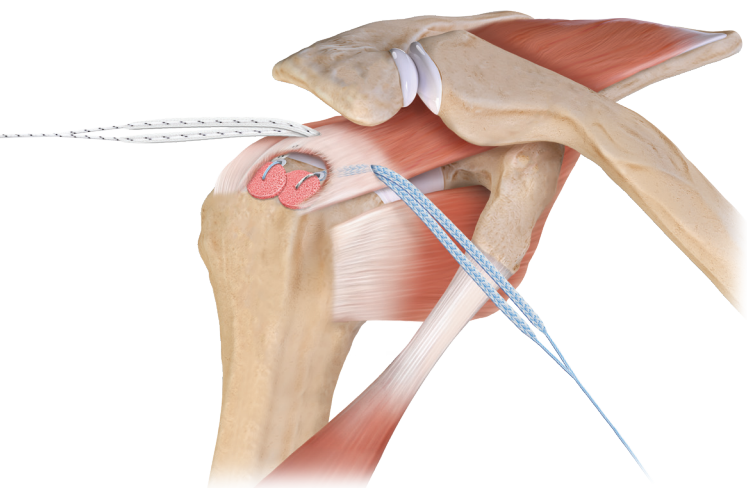

# ALLOSYNC

## AlloSync™ Demineralized Cancellous Sponges, Chips, and Cortical Fibers

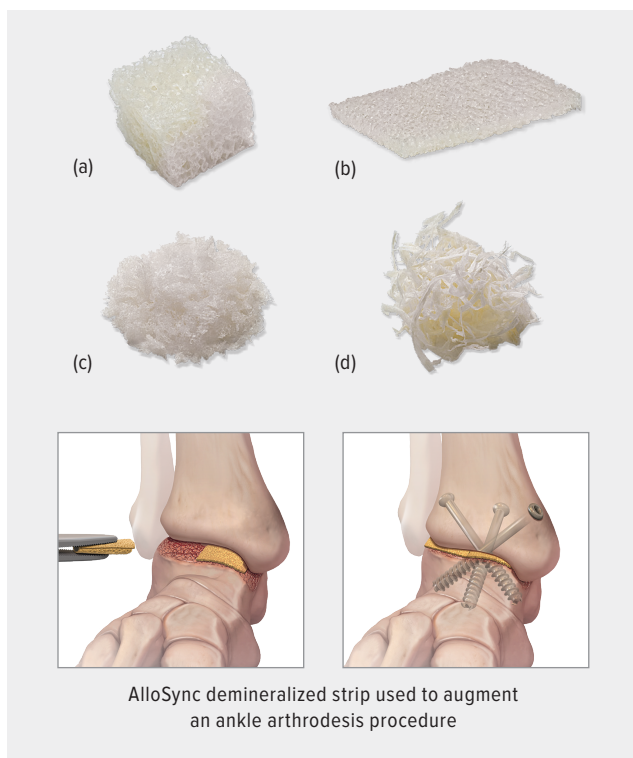

### Cancellous Sponges

- Post-sterilization, every lot is tested in vivo to ensure osteoinductivity
- Demineralized cancellous matrix is comprised of 100% cancellous bone
- Maintains natural bone architecture with interconnected porosity
- Provides optimal scaffold for cellular attachment and proliferation
- Contains exposed natural growth factors with verified osteoinductivity<sup>16</sup>
- Naturally absorbs and retains bioactive fluids like PRP and BMA
- After rehydration, the product is compressible like a sponge, allowing for flexibility to fit in and around different types of bone defects
- Sterile to device-grade standards (10<sup>-6</sup>) and stored at ambient temperature

### Demineralized Cortical Fibers

- New form of 100% DBM offering excellent handling characteristics without the need for an additional carrier
- Osteoconductive and verified osteoinductive properties<sup>16</sup>
- The cortical fibers are demineralized using a proprietary process, optimizing the residual calcium level and osteoinductivity
- Demineralized cortical fibers provide an optimal scaffold for cellular attachment and proliferation
- Customizable hydration—naturally wicks up bioactive fluids such as PRP and concentrated BMA
- Sterile to device-grade standards (10<sup>-6</sup>) and stored at ambient temperature

### Cancellous Sponges

Product Description	Item Number
Cubes	
Cube, 8 mm × 8 mm × 8 mm <b>(a)</b>	ABS-2005-01
Cube, 10 mm × 10 mm × 10 mm	ABS-2005-02
Cube, 12 mm × 12 mm × 12 mm	ABS-2005-03
Strips	
Strip, 10 mm × 10 mm × 3 mm <b>(b)</b>	ABS-2006-01
Strip, 15 mm × 40 mm × 3 mm	ABS-2006-02
Strip, 26 mm × 19 mm × 7 mm	ABS-2006-03
Strip, 10 mm × 20 mm × 7 mm	ABS-2006-04
Chips	
Chips (1 mm-4 mm), 1 cc <b>(c)</b>	ABS-2007-01
Chips (1 mm-4 mm), 2.5 cc	ABS-2007-02
Chips (1 mm-4 mm), 5 cc	ABS-2007-03
Cortical Fibers	
Fibers, 1 cc <b>(d)</b>	ABS-2008-01
Fibers, 2.5 cc	ABS-2008-02
Fibers, 5 cc	ABS-2008-03
Fibers, 10 cc	ABS-2008-04

**ALLOSYNC**



## BioSurge™ Cell and Bone Graft Processing System

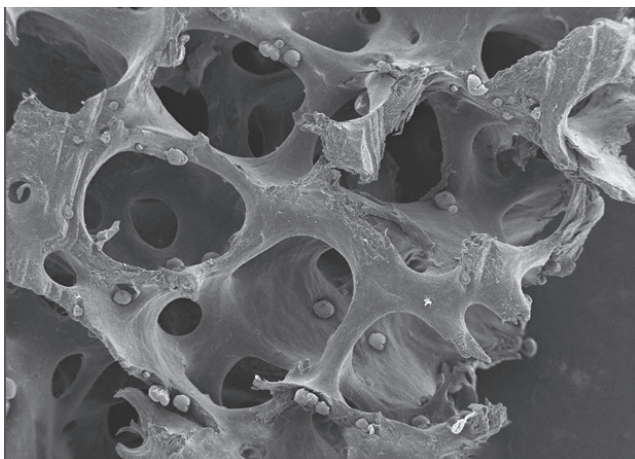

Electron microscopy image showing many healthy cells attached to the AlloSync bone graft scaffold after hydration.

The BioSurge cell and bone grafting processing system combines the superior matrices of the AlloSync™ bone grafting solutions line with the Angel® system's proprietary technology to prepare customized PRP concentrate from BMA. Hydrated AlloSync bone grafts provide the optimal scaffold for cPRP from BMA, which is a rich source of platelets, nucleated cells, and progenitor cells.

Product Description	Item Number
BioSurge I, 2.5 cc AlloSync Pure w/ Angel cPRP and BMA tray	<b>ABS-2016-01</b>
BioSurge II, 5 cc AlloSync Pure w/ Angel cPRP and BMA tray	<b>ABS-2016-02</b>
BioSurge III, 15 mm × 40 mm × 3 mm AlloSync DBM cancellous strip w/ Angel cPRP and BMA tray	<b>ABS-2016-03</b>
BioSurge V, 12 mm × 3 mm AlloSync button disc w/ Angel cPRP and BMA tray	<b>ABS-2016-05</b>

**BioSurge**  
Cell & Bone Graft Processing System

## AlloSync Cancellous Chips, Cubes, and Cancellous Crush



AlloSync cancellous cubes, chips, and cancellous crush provide an osteoconductive scaffold for bone ingrowth and allow for remodeling with the patient's own bone. AlloSync cancellous bone grafts are available in multiple sizes and quantities.

Product Description	Item Number
AlloSync Cancellous Cubes	
AlloSync Cancellous Cube, 15 cc	<b>ABS-2900-15</b>
AlloSync Cancellous Cube, 30 cc	<b>ABS-2900-30</b>
AlloSync Cancellous Chips	
AlloSync Cancellous (1 mm-4 mm) Chips, 5 cc	<b>ABS-2901-05</b>
AlloSync Cancellous (1 mm-4 mm) Chips, 15 cc	<b>ABS-2901-15</b>
AlloSync Cancellous (1 mm-4 mm) Chips, 30 cc	<b>ABS-2901-30</b>
AlloSync Cancellous (4 mm-10 mm) Chips, 5 cc	<b>ABS-2910-05</b>
AlloSync Cancellous (4 mm-10 mm) Chips, 15 cc	<b>ABS-2910-15</b>
AlloSync Cancellous (4 mm-10 mm) Chips, 30 cc	<b>ABS-2910-30</b>
AlloSync Cancellous Crush	
AlloSync Cancellous Crush, 5 cc	<b>ABS-2905-05</b>

**ALLOSYNC**



## AlloSync™ Cotton and Evans Wedges



The AlloSync allograft reconstruction wedges are anatomically contoured grafts for Cotton and Evans procedures. These wedges are identical to the shapes and sizes currently provided in the BioSync® titanium wedge line.

- 100% allograft cancellous bone
- Dense cancellous bone material harvested from the femoral head, condyles, distal tibia, and talus for added strength during insertion
- Sterile to device grade standards ( $10^{-6}$  SAL)
- Ambient temperature storage
- Grafts are stored hydrated in saline solution
- 4-year shelf life

### AlloSync Wedges

Product Description	Item Number
<b>AlloSync Cotton Wedges</b>	
16 mm × 4.5 mm (a)	ABS-2800-1645
16 mm × 5.5 mm	ABS-2800-1655
16 mm × 6.5 mm	ABS-2800-1665
16 mm × 7.5 mm	ABS-2800-1675
20 mm × 4.5 mm	ABS-2800-2045
20 mm × 5.5 mm	ABS-2800-2055
20 mm × 6.5 mm	ABS-2800-2065
20 mm × 7.5 mm	ABS-2800-2075
<b>AlloSync Evans Wedges</b>	
18 mm × 18 mm × 6.5 mm	ABS-2810-1806
18 mm × 18 mm × 8 mm	ABS-2810-1808
18 mm × 18 mm × 10 mm	ABS-2810-1810
18 mm × 18 mm × 12 mm	ABS-2810-1812
20 mm × 20 mm × 6.5 mm	ABS-2810-2006
20 mm × 20 mm × 8 mm	ABS-2810-2008
20 mm × 20 mm × 10 mm	ABS-2810-2010
20 mm × 20 mm × 12 mm	ABS-2810-2012
22 mm × 22 mm × 6.5 mm	ABS-2810-2206
22 mm × 22 mm × 8 mm	ABS-2810-2208
22 mm × 22 mm × 10 mm	ABS-2810-2210
22 mm × 22 mm × 12 mm	ABS-2810-2212

## AlloSync™ Bone PIP Dart for Hammertoe Arthrodesis

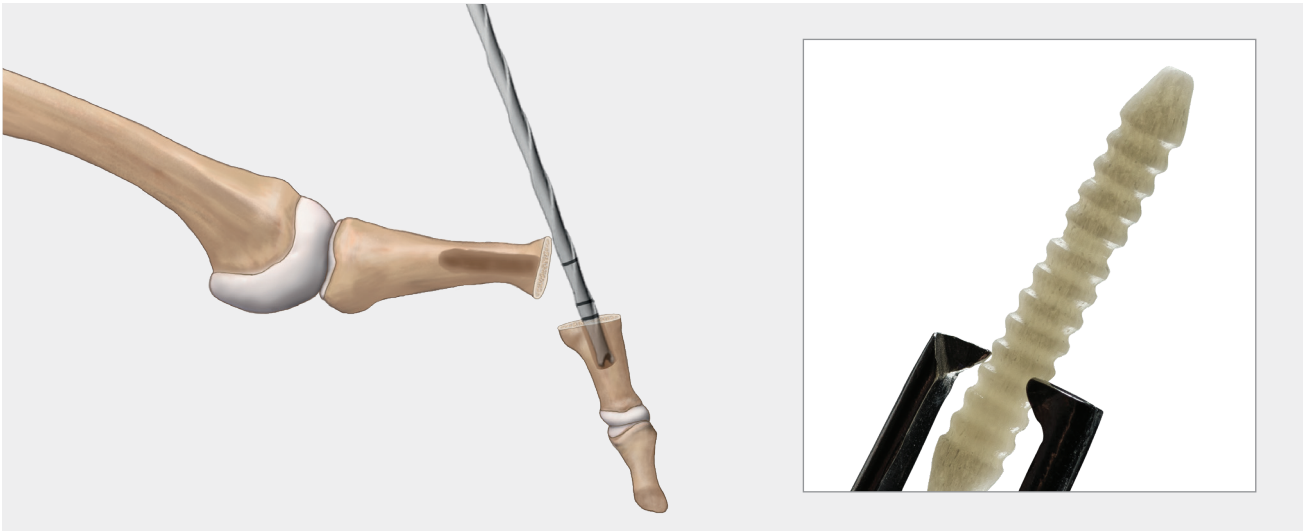

The AlloSync bone dart implant is a biologic alternative to traditional hammertoe implants. Made from allograft bone, AlloSync bone dart implants provide an optimal scaffold for bone incorporation and may reduce the potential complications of future hardware removal from hammertoe PIP arthrodesis.

AlloSync bone dart implants were manufactured with numerous design characteristics to make them effective and easy to use. The reversed barbs were created to ensure the implant stays in place. Tapered ends and a depth mark were incorporated into the design to make implantation easier. Soaking the implant in ACP/PRP or BMA will allow for the patient's own growth factors and cells to assist with the healing process.

Product Description	Item Number
AlloSync Bone Dart, 3 mm × 22 mm	ABS-2802

### AlloSync Bone Dart Disposables Kit

Product Description	Item Number
AlloSync Bone Dart Disposables Kit	ABS-2802DS
<ul style="list-style-type: none"> <li>■ 2.5 mm Drill Bit, cannulated</li> <li>■ 2.7 mm Drill Bit, cannulated</li> <li>■ 3.0 mm Drill Bit, cannulated</li> <li>■ 1.1 mm Guidewire</li> <li>■ Profile Drill</li> <li>■ Inserter</li> </ul>	

### AlloSync Bone Dart Implant

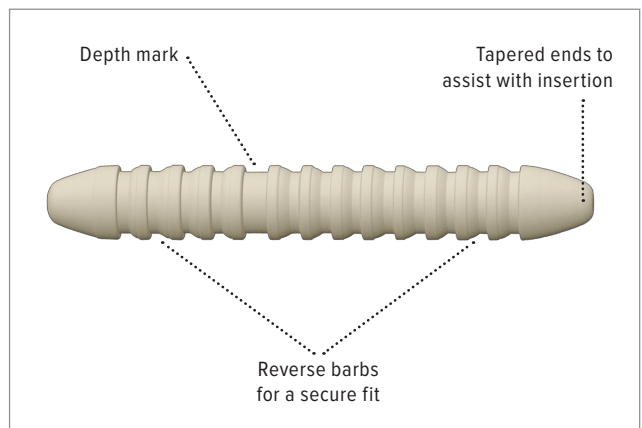

## StimuBlast® Demineralized Bone Matrix



Product Description	Item Number
<b>StimuBlast DBM Putty</b>	
Putty, 1 cc	ABS-2001-01
Putty, 2.55 cc	ABS-2001-02
Putty, 5 cc	ABS-2001-05
Putty, 10 cc	ABS-2001-10
<b>StimuBlast DBM Gel</b>	
Gel, 1 cc	ABS-2002-01
Gel, 5 cc	ABS-2002-05
Gel, 10 cc	ABS-2002-10
<b>StimuBlast CB DBM Putty</b>	
Putty, 5 cc	ABS-2003-05
Putty, 10 cc	ABS-2003-10
<b>StimuBlast CB DBM Paste</b>	
Paste, 1 cc	ABS-2004-01
Paste, 3 cc	ABS-2004-03
Paste, 8 cc	ABS-2004-08
Cancellous Crushed, 5 cc	27715005

### StimuBlast Bone Products May Provide Osteoinductive and Osteoconductive Properties

- Osteoinduction—signaling molecules such as bone morphogenetic proteins (BMPs) that aid in cell differentiation down osteoblastic pathways
- Every lot of demineralized bone matrix (DBM) is tested for osteoinductive potential, using either an in vitro assay or in vivo model
- Osteoconduction—scaffolding from DBM particles for osteoblasts to form new bone
- Additional scaffolding properties are provided in StimuBlast cancellous bone with the addition of cancellous bone chips

### Superior Handling Characteristics via the Reverse-Phase Medium (RPM) Carrier

- RPM is an inert, biocompatible copolymer consisting of polypropylene oxide and polyethylene oxide
- Material is flowable at room temperature and thickens to become more viscous at body temperature
- RPM allows the DBM graft to be moldable and packed into any defect size or shape
- StimuBlast bone products will resist irrigation and can be used in a fluid environment without the fear of graft migration, unlike some other DBMs

### StimuBlast Bone Products Offer Ease of Use and Terminal Sterility

- Provided as a ready-to-use, off-the-shelf product that requires no thawing or premixing preparation
- Terminal sterilization using electron beam results in a sterility assurance level (SAL) of  $10^{-6}$
- Some competitive DBM products are only offered as aseptically processed products with a SAL of  $10^{-3}$
- Room temperature storage

StimuBlast bone products are indicated for orthopedic applications as filler for gaps or voids that are not intrinsic to the stability of the bony structure. StimuBlast bone products are indicated to be packed gently into bony gaps in the skeletal system as a bone graft extender (extremities, spine, and pelvis) and as bony void filler of the extremities and pelvis. These defects may be surgically created or result from traumatic injury to the bone.

StimuBlast is a registered trademark of AlloSource.

# STIMUBLAST®

## Cannulated Revision Bone Dowels

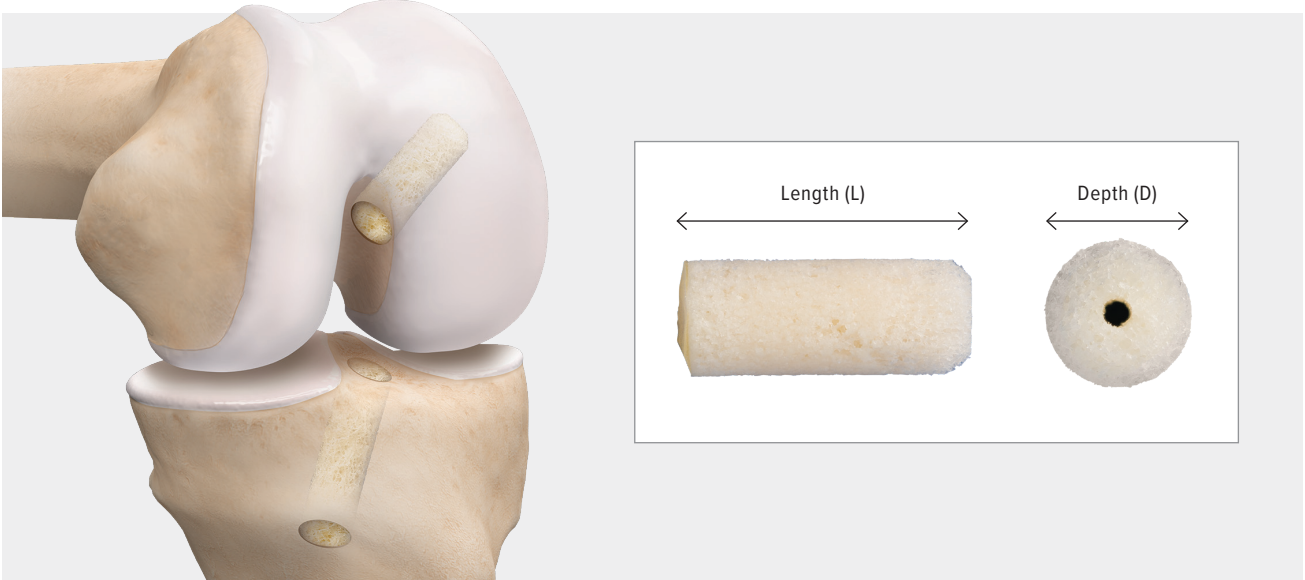

Cannulated revision bone dowels offer surgeons a quick and effective solution for filling bone tunnels during staged ACL/PCL revision cases. They are also an effective solution for filling the bone void in the 1st metatarsal head after the removal of a failed synthetic cartilage implant. The use of bone dowels provides an immediate structural and biologic architecture for stability and incorporation. Soaking the dowels in PRP or bone marrow concentrate infuses growth factors and cells that assist with incorporation of the scaffold.

Cannulated revision bone dowels, treated with the Allowash XG® process to clean the scaffold, are preshaped with a tapered tip and cannulated for easier implantation. Treatment with Preservon® technology allows for the revision bone dowels to be stored in a prehydrated state for up to 5 years.

- Ready to use
- Prehydrated with Preservon technology
- 5-year shelf life
- 10<sup>-6</sup> sterility assurance level
- Cannulated
- Bullet design

### Length 25 mm–29 mm

Diameter	LifeNet Health Part No.
9 mm	PCD9
10 mm	PCD10
11 mm	PCD11
12 mm	PCD12
13 mm	PCD13
14 mm	PCD14
16 mm	PCD16

### Length 30 mm–35 mm

Diameter	LifeNet Health Part No.
9 mm	PCDXL9
10 mm	PCDXL10
11 mm	PCDXL11
12 mm	PCDXL12
13 mm	PCDXL13
14 mm	PCDXL14
16 mm	PCDXL16
18 mm	PCDXL18

<sup>a</sup>Allowash XG and Preservon are registered trademarks of LifeNet Health.



## Bone Dowel Revision Kit

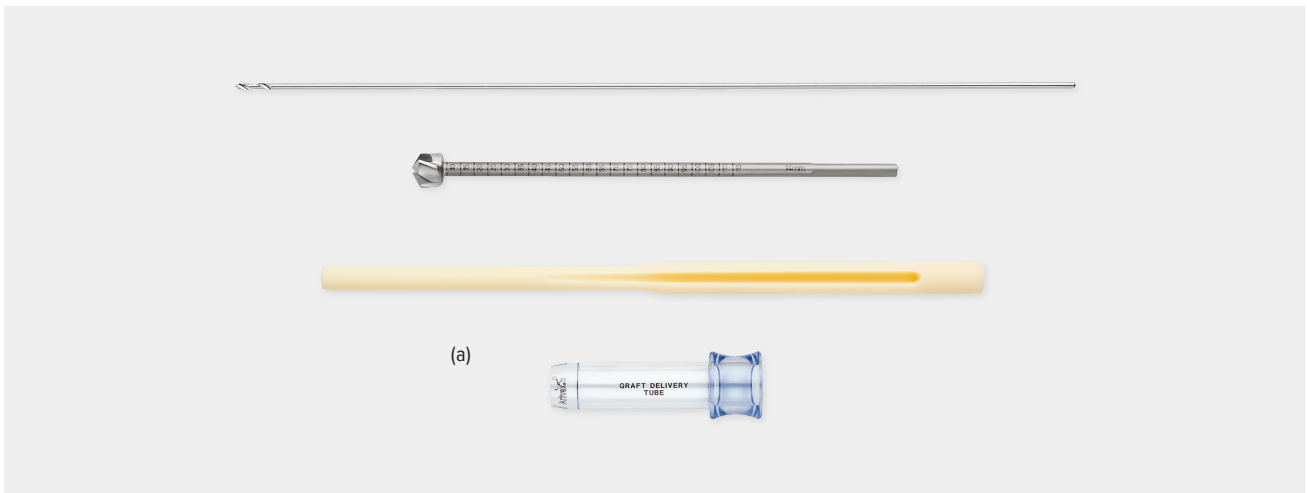

The Arthrex cannulated bone dowel kit simplifies bone tunnel restoration for revision procedures by combining properly sized reamers and a cannulated bone tamp in a single-use kit. The bone tamp was designed for use with a guide pin to allow for proper placement of the cannulated bone dowels into bone tunnels. Using allograft bone dowels to fill bone voids allows for the immediate management of widened tunnels and cystic bone areas.<sup>17</sup> It is estimated that between 1.8% and 10.4% of patients with an ACL reconstruction will require a revision.<sup>18</sup> Restoration of widened tunnels can be challenging, sometimes requiring a two-stage approach.<sup>19</sup> Favorable outcomes have been reported for patients undergoing single-stage ACL reconstruction using allograft bone dowels.<sup>20</sup>

Product Description	Item Number
Bone Dowel Revision Kit, 9 mm	ABS-2850-09
Bone Dowel Revision Kit, 10 mm	ABS-2850-10
Bone Dowel Revision Kit, 11 mm	ABS-2850-11
Bone Dowel Revision Kit, 12 mm	ABS-2850-12
Bone Dowel Revision Kit, 13 mm	ABS-2850-13
Bone Dowel Revision Kit, 14 mm (a)	ABS-2850-14
Bone Dowel Revision Kit, 16 mm	ABS-2850-16
Bone Dowel Revision Kit, 18 mm	ABS-2850-18

Kits contain a cannulated bone tamp, 2.4 mm guide pin, delivery tube, and cannulated reamer.



## BoneSync™ BioActive Matrix

BoneSync BioActive is a second-generation bone void filler that includes bioglass 45S5 and provides an osteoconductive and osteostimulative matrix.<sup>21</sup> BoneSync BioActive bone void filler is available in putty and strip versions to fit various application needs. BoneSync BioActive filler is comprised of 50% carbonate apatite anorganic bone mineral, 30% 45S5 bioactive glass, and 20% Type I collagen. BoneSync BioActive was developed to resemble the composition and pore structure of natural human bone.<sup>22,23</sup> The synthetic bone void filler is slowly resorbed and replaced by new bone tissue during the healing process.

Product Description	Item Number
BioActive Matrix Strip, 5cc	ABS-3500-05
BioActive Matrix Strip, 10cc	ABS-3500-10
BioActive Matrix Strip, 20cc	ABS-3500-20
BioActive Matrix Strip, 40cc	ABS-3500-40
BioActive Matrix Putty, 2.5cc	ABS-3400-02
BioActive Matrix Putty, 5cc	ABS-3400-05
BioActive Matrix Putty, 10cc	ABS-3400-10
BioActive Matrix Putty, 20cc	ABS-3400-20

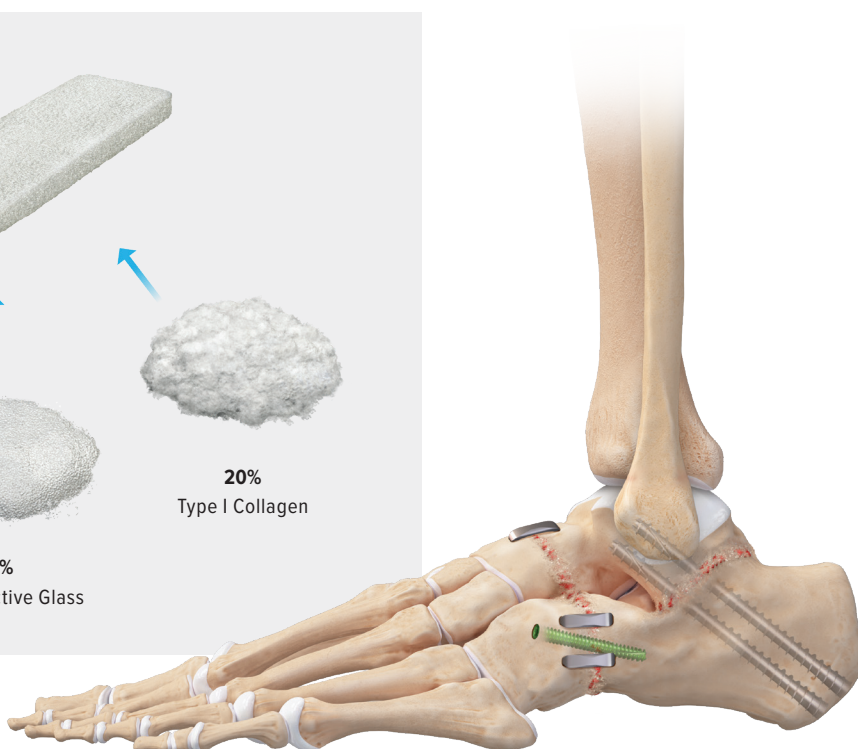
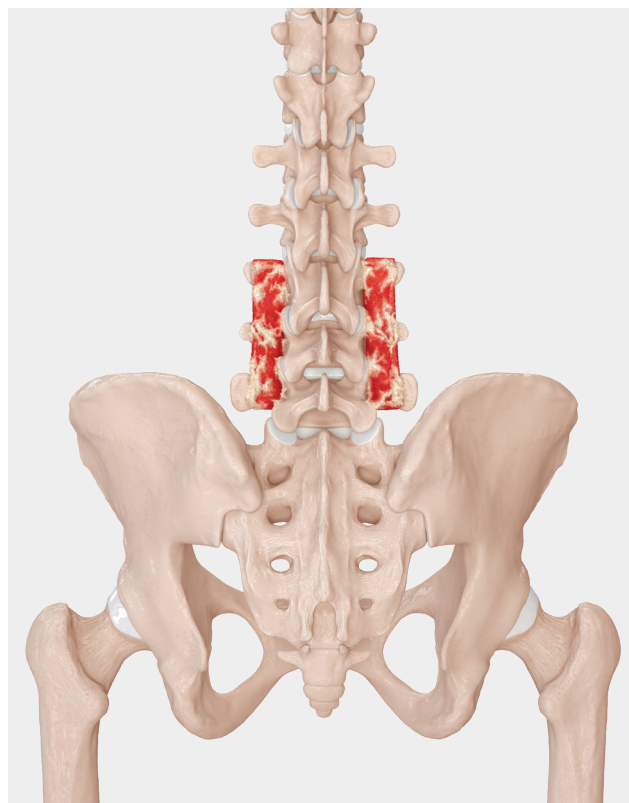

**BONESYNC**  
BIOACTIVE



## BoneSync™ Putty and Strips



The blend of 20% type I collagen and 80% highly purified beta-tricalcium phosphate ( $\beta$ -TCP) in the BoneSync putty and strips provides an osteoconductive material for bone regeneration. It was developed to resemble the composition and pore structure of natural human bone.<sup>24</sup>

### Benefits of the Collagen-Engineered Matrix in Orthopedic Applications

- Specifically engineered to provide a scaffold with porosity
- Facilitates incorporation of cells in BMA and tissue cells during the healing process<sup>25</sup>
- BoneSync collagen is composed of highly purified type I collagen, the most abundant type of collagen found in bone
- Purification and biocompatibility minimizes the potential for immune response
- Can be hydrated with biologic fluids, such as BMA

#### BoneSync Putty

Product Description	Item Number
Putty, 2.5 cc	ABS-3202
Putty, 5 cc	ABS-3205
Putty, 10 cc	ABS-3210
Putty, 15 cc	ABS-3215

#### BoneSync Strips

Product Description	Item Number
Strip, 10 cc	ABS-3310
Strip, 15 cc	ABS-3315

## BoneSync™ Fast-Setting, Drillable Calcium Phosphate Cement

BoneSync cement is a fast-setting, synthetic bone void filler that sets within 5 to 8 minutes, depending on whether it's prepared with saline, blood, or bone marrow.

- BoneSync bone void filler is provided in a self-contained mixing and delivery system to decrease preparation time and improve delivery
- BoneSync cement may be mixed with saline, blood, or BMA
- BoneSync cement is fast-setting to allow immediate supplemental fixation or to add strength to the surgical repair site
- Following curing, BoneSync cement is drillable to assist fracture repair and fixation
- Final product expands to improve contact forces with surrounding bone and/or plates or screw fixation
- BoneSync bone void filler is a resorbable bone cement

### Indications for Use

- BoneSync cement is indicated to fill bony voids or gaps of the skeletal system (ie, extremities and pelvis); these defects may be surgically created or they may be osseous defects from traumatic injury to the bone
- BoneSync cement is indicated only for bony voids or gaps that are not intrinsic to the stability of the bony structure
- When cured in situ, BoneSync cement provides an open void/gap filler that can augment provisional hardware (eg, K-wires, plates, screws) to help support bone fragments during the surgical procedure
- The cured cement acts only as a temporary support media and is not intended to provide structural support during the healing process
- BoneSync cement resorbs and is replaced by bone during the healing process



BoneSync Kit Package (a)

Product Description	Item Number
BoneSync Cement, 3 cc	ABS-3103
BoneSync Cement, 5 cc	ABS-3105
BoneSync Cement, 10 cc (2 × 5 cc kit) (a)	ABS-3105-2

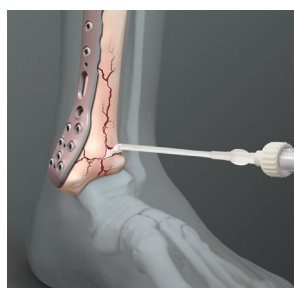
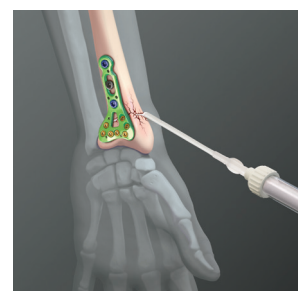
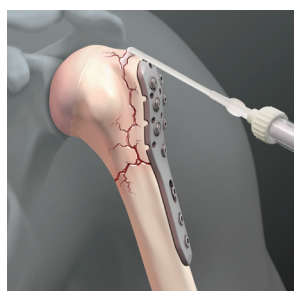

# BONESYNC

## Quickset™ Calcium Phosphate Cement



Product Description	Item Number
Quickset Cement, 5 cc	ABS-3005
Quickset Cement, 8 cc	ABS-3008
Quickset Cement, 16 cc	ABS-3016

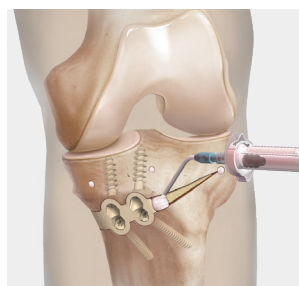

iBalance® HTO

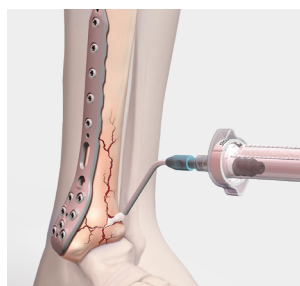

Pilon Fracture



Calcaneus Fracture



Quickset cement is a macroporous, injectable, hardening, resorbable bone cement provided in an easy-to-use, closed mixing system.

### Composition

- The mixing system is a dual-chambered syringe containing a powder and mixing liquid
- The powder chamber contains a mixture of calcium phosphates and an organic polysaccharide polymer; the polysaccharide is a highly biocompatible polymer that optimizes the viscosity, cohesiveness, and macroporosity
- The mixing liquid consists of a sodium phosphate solution that facilitates the setting time (crystallization) of the cement
- The end product is a calcium-deficient apatite very similar to the mineral phase of bone

### Physical and Chemical Properties

- Global porosity of 70%
  - Microporosity (<10 µm): 88%
  - Mesoporosity (10 µm-100 µm): 2%
  - Macroporosity (>100 µm): 10%
- Porosity is present by the time it reaches complete hardening (24 hours after implantation)
- Mechanical compressive strength of 24 MPa (24 hours after implantation)
- Excellent cohesiveness, which prevents "washout" by biological fluids
- No shrinkage during crystallization
- Nonexothermic reaction
- Radiopaque

### Preparation

- Mixing time (room temperature): 2 minutes
- Injection time (room temperature): 2 minutes
- Initial setting time (body temperature): 8 minutes
- Complete hardening (body temperature): 24 hours

Quickset cement is intended for bony voids or defects that are not intrinsic to the stability of the bony structure. Quickset cement is intended to be placed or injected into bony voids or gaps of the skeletal system (ie, the extremities and pelvis). These defects may be surgically created osseous defects or osseous defects created from traumatic injury to the bone. The product provides bone void filler that resorbs and is replaced with bone during the healing process.

Quickset cement is available in the US as a convenience kit containing Quickset cement, a cannula, and a delivery gun.

Quickset is a trademark of Graftys, S.A.

**QUICKset™**

## OSferion Wedges

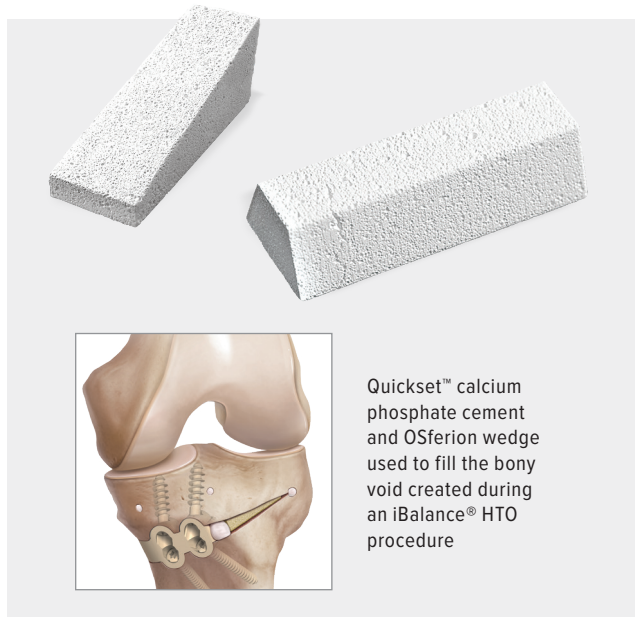

### OSferion Osteotomy Wedge

Product Description	Item Number
OSferion Osteotomy Wedge, 7 mm × 30 mm	AR-13370-1
OSferion Osteotomy Wedge, 10 mm × 30 mm	AR-13370-2
OSferion Osteotomy Wedge, 12 mm × 35 mm	AR-13370-3
OSferion Osteotomy Wedge, 15 mm × 35 mm	AR-13370-4

### OSferion Trapezoid

Product Description	Item Number
OSferion Trapezoid, 8 × 25 × 7 mm × 75°	AR-13372-1
OSferion Trapezoid, 9 × 25 × 7 mm × 75°	AR-13372-2
OSferion Trapezoid, 10 × 25 × 7 mm × 75°	AR-13372-3

OSferion is an osteoconductive bone graft substitute and bone void filler consisting of 100% high-purity beta-tricalcium phosphate ( $\beta$ -TCP). OSferion wedges are intended to be used together with the distal femoral and high tibial opening wedge osteotomy plates and screws to promote healing and provide added rigidity to the repair.

- Allows for simultaneous controlled absorption and promotion of osteogenesis
- Microporous and macroporous structure promotes vascularization<sup>26</sup> and the entry of proteins into cells for bone formation<sup>27</sup>
- The material has a compressive force of up to 20 MPa (2900 lb/in<sup>2</sup>)

### OSferion Trapezoids

- Intended to be used as a bone-patellar tendon-bone (BTB) graft harvest site bone void filler in the patella and tibia
- OSferion naturally wicks up autologous blood and/or bone marrow
- Can easily be customized using a rongeur or oscillating saw

## OsteoAuger™ Bone Graft Harvesting System

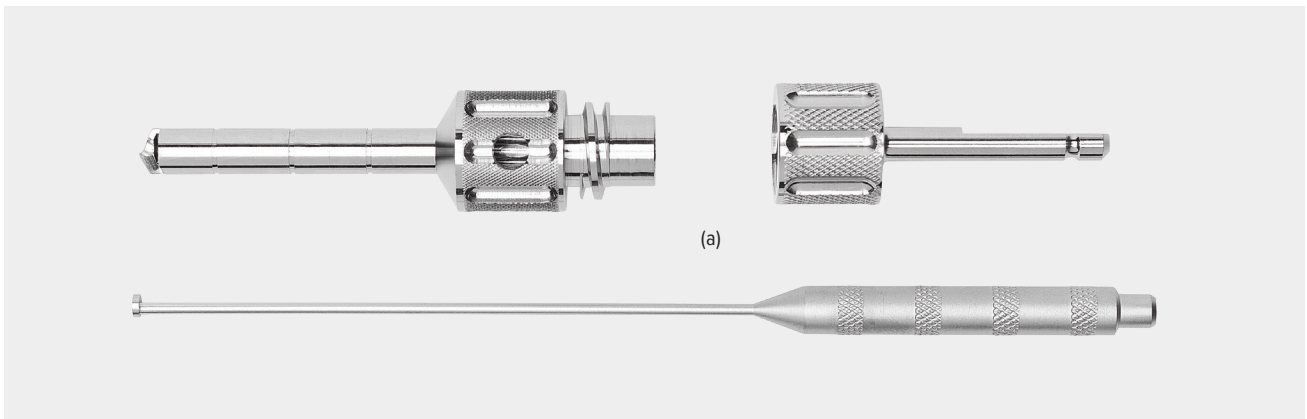

The OsteoAuger bone graft harvesting system allows for the quick and efficient recovery of autologous bone from various anatomic sites. The system morselizes and collects the bone graft for reimplantation at the repair site. The new bone graft harvesters conveniently feature an AO connection and can be easily disassembled from the reamer. A plunger is included with each harvester to assist with the removal of procured autograft.

Product Description	Item Number
OsteoAuger Bone Graft Harvesting System, 6 mm (a)	ABS-8000-06
OsteoAuger Bone Graft Harvesting System, 8 mm	ABS-8000-08
OsteoAuger Bone Graft Harvesting System, 10 mm	ABS-8000-10

### Harvest Sites Include:

- Distal tibia (6 mm, 8 mm, and 10 mm)
- Proximal tibia (8 mm and 10 mm)
- Iliac crest (6 mm and 8 mm)
- Distal radius (6 mm)

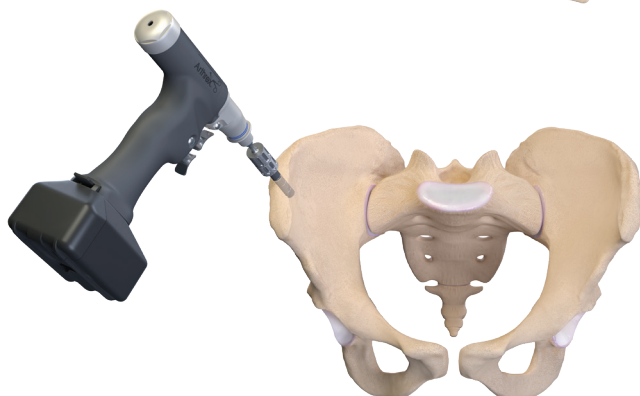
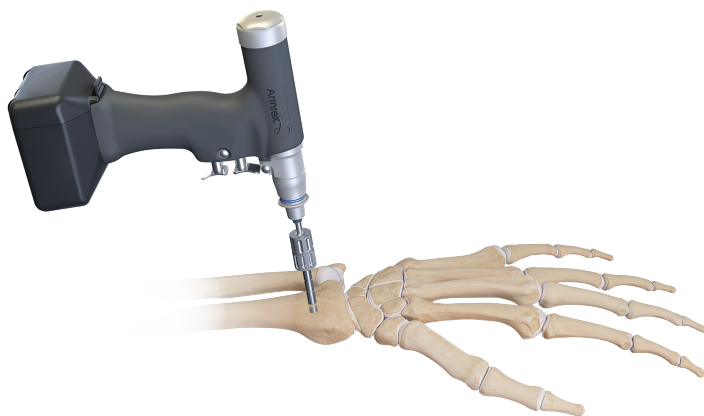



## GraftNet™ Autologous Tissue Collector for Bone

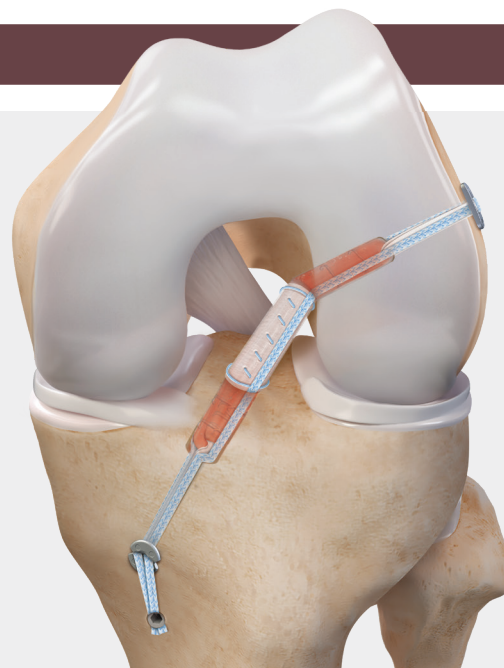

The suction-activated GraftNet device is designed to collect autologous tissue for a multitude of applications. When connected to an arthroscopic shaver, the GraftNet device may be used to remove tissue debris, soft tissue, or cartilage from a surgical site. This recovered autologous tissue is collected in an easily accessed, sterile filtered chamber. The GraftNet autologous tissue collector makes gaining access to autograft tissue as simple as Resect and Collect™.

- Universal adapters make for easy assembly
- Collect autologous bone, cartilage, or soft tissue
- Quickly access recovered tissue volume
- Control the particulate size when using a shaver device

### Bone Repair Applications

- When preparing an ACL tunnel for BTB reconstruction, use the GraftNet to recover bone that can be used to backfill the harvest site
- A suction wand may be helpful to recover bone in a nonarthroscopic environment
- Once recovered, mix the autograft bone with ACP or cPRP from BMA processed with the Angel® system

Product Description	Item Number
GraftNet Autologous Tissue Collector	ABS-1050

**GraftNet™**  
AUTOLOGOUS TISSUE COLLECTOR







# Cartilage and Meniscus

GraftNet™ Autologous Tissue Collector.....	44
BioCartilage® Extracellular Matrix.....	45
Cartiform® Viable Osteochondral Allograft.....	46
Autograft OATS® and Autograft OATS 2.0 Sets .....	47
Small Joint OATS Sets.....	47
OATS AlloPlug and FlexiGRAFT® Cancellous Plugs .....	48
Fresh Cartilage.....	49
Precut Fresh OCA Cores .....	50
Allograft OATS System.....	50
BioUni® OCA Instrument Set.....	51
BioPatella™ OATS System.....	52
Talus OATS Instrumentation Set .....	53
Meniscus Allografts .....	53
Meniscal Implantation Techniques.....	54
Segmental Meniscus Transplant.....	55
IntraOsseous BioPlasty® (IOBP®) System .....	56
IntraOsseous BioPlasty System (Cont.).....	57

## GraftNet™ Autologous Tissue Collector



The suction-activated GraftNet device is designed to collect autologous tissue for a multitude of applications. When connected to an arthroscopic shaver, the GraftNet device may be used to remove tissue debris, soft tissue, or cartilage from a surgical site. This recovered autologous tissue is collected in an easily accessed, sterile filtered chamber. The GraftNet autologous tissue collector makes gaining access to autograft tissue as simple as Resect and Collect™.

- Universal adapters make for easy assembly
- Collect autologous bone, cartilage, or soft tissue
- Quickly access recovered tissue volume
- Control the particulate size when using a shaver device

Product Description	Item Number
GraftNet Autologous Tissue Collector	ABS-1050

### Accessories

Product Description	Item Number
Mixing and Delivery Kit, large joint	ABS-1000-L
Mixing and Delivery Kit, small joint	ABS-1000-S
Mixing and Delivery Kit, hip joint	ABS-1000-H
BioXpress™ Graft Delivery Device, 10 cm	ABS-10053-10

### Cartilage

- Autograft OATS® procedures are the benchmark when treating small, symptomatic articular cartilage lesions
- Assemble the GraftNet tissue collector to the Bone Cutter device in oscillate mode to resect and particulate an osteochondral autograft from OATS harvest sites
- Data indicates chondrocytes maintain excellent viability (>80%) and metabolic activity<sup>28</sup>



**GraftNet™**  
 AUTOLOGOUS TISSUE COLLECTOR

## BioCartilage® Extracellular Matrix

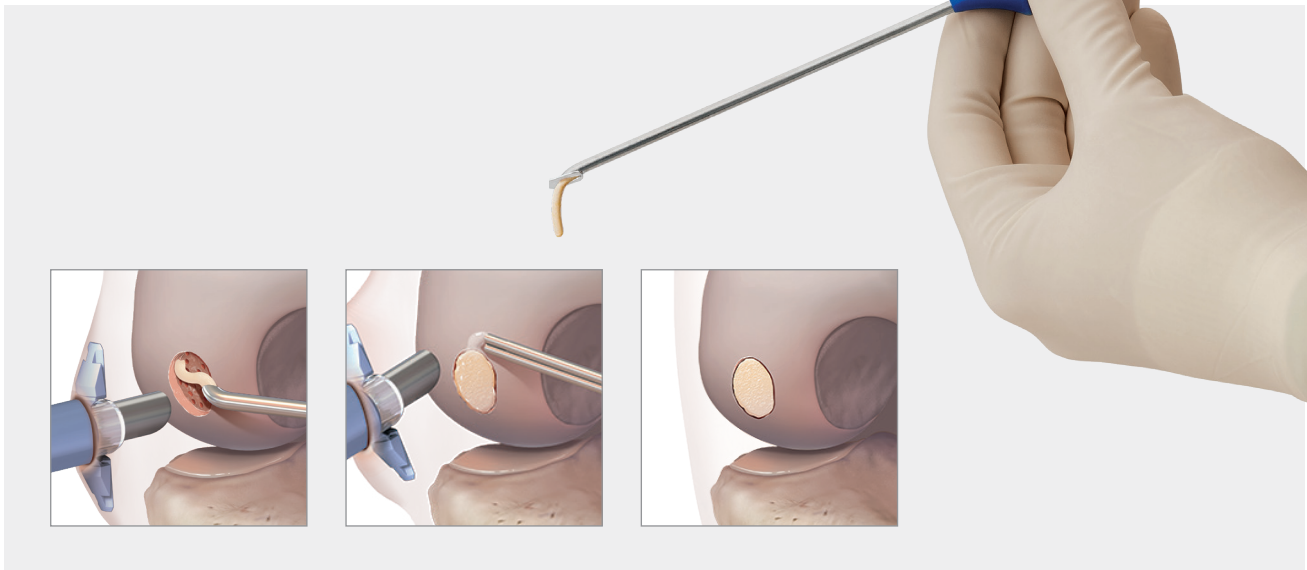

BioCartilage extracellular matrix was designed to provide a reproducible, simple, and inexpensive method to augment traditional marrow stimulation procedures. There is scientific evidence to support the premise that a dehydrated, allograft-cartilage scaffold used as an adjunct to marrow stimulation may improve the degree and quality of tissue healing within a properly prepared articular cartilage defect.<sup>29,30</sup> Primate study indicates repopulation of the defect with hyaline-like cartilage at 12 weeks.<sup>31</sup>

BioCartilage extracellular matrix is an injectable cartilage-scaffold paste that can fill a cartilage defect subsequent to marrow stimulation. Difficult-to-reach focal defects can be treated open or arthroscopically with a unique delivery system.

- BioCartilage allograft contains the extracellular matrix that is native to articular cartilage, including key components such as type II collagen (Figure 1), proteoglycans (Figure 2), and additional cartilaginous growth factors
- The principle of BioCartilage extracellular matrix is to serve as a scaffold over an articular cartilage defect to provide a tissue network that can potentially signal autologous cellular interactions
- Marrow elements will fill the cartilage lesion and interact with the scaffold created by BioCartilage extracellular matrix instead of the lesion being expected to create its own fibrin scaffold, as typically anticipated from a marrow stimulation procedure

Product Description	Item Number
BioCartilage Extracellular Matrix, 0.75 cc	ABS-1007-BC
BioCartilage Extracellular Matrix, 1 cc	ABS-1010-BC
Mixing and Delivery Kit, large joint	ABS-1000-L
Mixing and Delivery Kit, small joint	ABS-1000-S
Mixing and Delivery Kit, hip kit	ABS-1000-H

### Accessories

Product Description	Item Number
PowerPick™ XL Microfracture Instrument, 45°, 6 mm depth	AR-8150PX-45

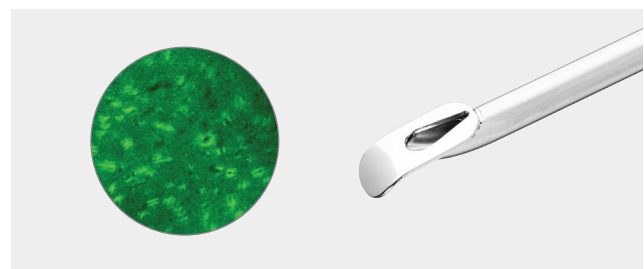

**Figure 1.** Immunohistochemistry staining for type II collagen.<sup>a</sup>



**Figure 2.** Toluidine blue stain highlighting proteoglycan content.<sup>a</sup>

<sup>a</sup>The tissue was stained after the dehydration step.

## Cartiform® Viable Osteochondral Allograft

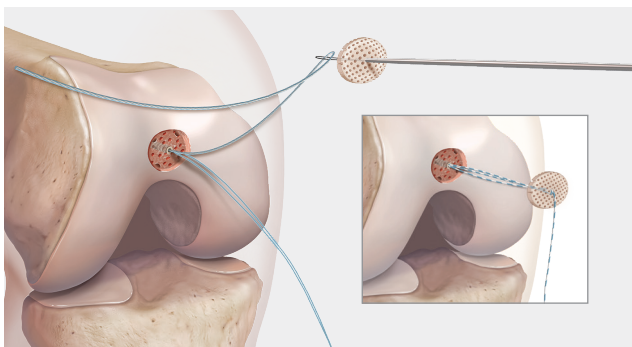
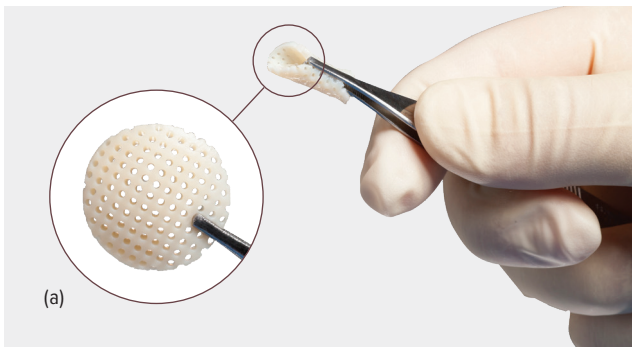

Fixation of Cartiform viable osteochondral allograft in the trochlea is achieved with the Knotless SutureTak® percutaneous insertion kits.

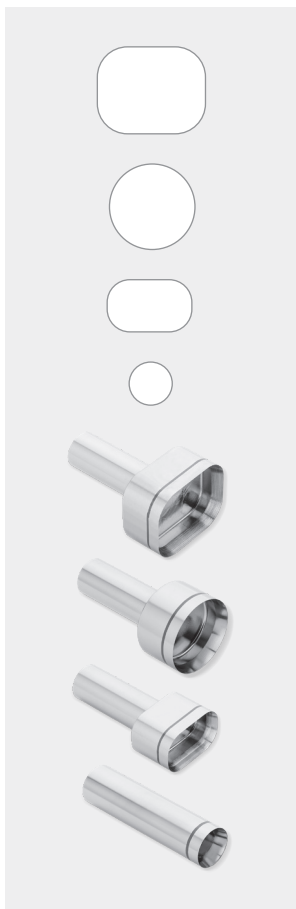

Cartiform viable osteochondral allograft may be trimmed to fit the articular cartilage lesion. Templates and scorers are available to aid in preparation of the graft and recipient site.

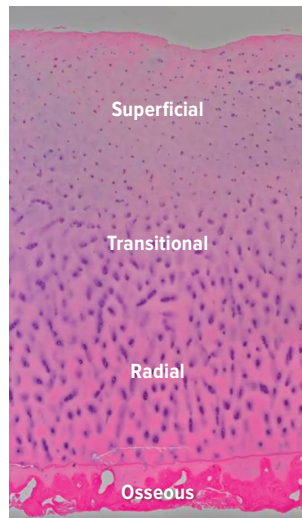

**Figure 1.** Structural organization of Cartiform allograft. Cartiform viable osteochondral allograft preserves the microstructure of 3 distinct cartilage zones (superficial, transitional, and radial) and an osseous layer as evident on histological staining (H&E).

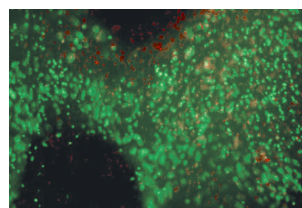

**Figure 2.** Live (green) and dead (red) cell staining of Cartiform unit post-thaw after 2.7 years storage at  $-80^{\circ}\text{C}$ , 70% cell viability.

Cartiform allograft is a cryopreserved osteochondral allograft composed of viable chondrocytes, chondrogenic growth factors, and extracellular matrix proteins. While maintaining an intact cartilage structure (Figure 1), the bony portion of the osteochondral allograft is minimal and the graft is porated to offer unique handling characteristics and simple fixation techniques.

**Cartiform viable osteochondral allograft is recovered with minimal bone and porated for a variety of reasons:**

- The minimal bone and pores impart flexibility to the allograft
- The pores increase the surface area and allow for the proprietary cryopreservative solution to preserve chondrocyte viability
- The pores facilitate enhanced growth factor release from Cartiform viable osteochondral allograft

Cartiform viable osteochondral allograft combines the safety and success of traditional fresh stored osteochondral allografts with ease of use, as the graft is trimmable and flexible to match any lesion size and contour.

Stored in a proprietary cryopreservative solution, Cartiform viable osteochondral allograft is readily available and is stored at  $-80 \pm 5^{\circ}\text{C}$ . (Figure 2).<sup>32</sup>

Product Description	Item Number
Cartiform Viable Osteochondral Allograft, 10 mm disc (a)	ABS-1101-10
Cartiform Viable Osteochondral Allograft, 12 mm × 19 mm	ABS-1102-19
Cartiform Viable Osteochondral Allograft, 20 mm disc	ABS-1101-20
Cartiform Viable Osteochondral Allograft, 20 mm × 25 mm	ABS-1102-25
Cartiform Templates	ABS-1100-T
Cartiform Scorer, 10 mm	ABS-1101-10S
Cartiform Scorer, 20 mm	ABS-1101-20S
Cartiform Scorer, 12 mm × 19 mm	ABS-1102-19S
Cartiform Scorer, 12 mm × 25 mm	ABS-1102-25S

Cartiform is a registered trademark of Osiris Therapeutics, Inc.



## Autograft OATS® and Autograft OATS 2.0 Sets



The autograft OATS (osteochondral autograft transfer system) technique is an excellent procedure for the repair of small osteochondral defects of the knee. Single-use OATS instrumentation may be used to facilitate the harvest of osteochondral/hyaline cartilage cores from a donor site superior and lateral to the notch or above the sulcus terminalis. The single-use OATS 2.0 kits include depth-stop features to aid in the preparation of the core and depth of the recipient site.

### Standard Autograft OATS Set

Product Description	Item Number
Osteotomy Wedge Set for HTO	AR-1981-06S
Single-Use OATS Set, 8 mm	AR-1981-08S
Single-Use OATS Set, 10 mm <b>(a)</b>	AR-1981-10S
OATS Sizer/Tamps Instrumentation Set	AR-1985S

### Single Use OATS 2.0 Set

Product Description	Item Number
Single-Use OATS Set, 6 mm	ABS-8981-06S
Single-Use OATS Set, 8 mm	ABS-8981-08S
Single-Use OATS Set, 10 mm <b>(b)</b>	ABS-8981-10S
Single-Use OATS Set, 12 mm	ABS-8981-12S

## Small Joint OATS Sets



Product Description	Item Number
Small Joint OATS Set, 6 mm	AR-8981-06S
Small Joint OATS Set, 8 mm	AR-8981-08S
Small Joint OATS Set, 10 mm	AR-8981-10S

The Small Joint OATS kit is a sterile, single-use set for the removal of osteochondral defects and transfer of autograft plugs to replace the defect. The set includes everything needed to perform this procedure on either the talus or the metatarsals.

The defect at the recipient site is drilled out using the guide pin and cannulated drill. The graft plug is harvested from a donor site to a controlled depth just longer than the depth of the drill hole at the recipient site. The graft plug is trimmed to length and press-fit into the recipient site with an extruder and/or tamp.

## OATS® AlloPlug and FlexiGRAFT® Cancellous Plugs

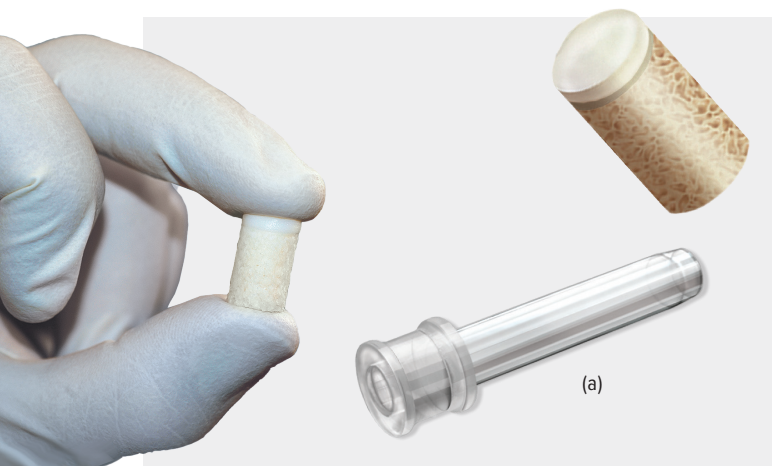

Surgeons concerned about possible donor site morbidity, caused by leaving the donor site sockets open, may now use these specially designed cancellous backfill plugs to fill the donor site and promote natural bone healing for a complete biologic repair.

AlloPlugs are processed from the articular surface, resulting in a multiphasic plug composed of a dense cancellous layer, a cortical layer, and a cartilage layer. These plugs come in a range of sizes from 7 mm to 11 mm in diameter and 16 mm in length.

FlexiGRAFT cancellous plugs are comprised of 100% human cancellous bone for use in backfill and bone void procedures. These plugs are provided sterile via the Allowash XG® process and stored in Preservon®, a proprietary glycerol-based preservation technology that allows allografts to be stored in a fully hydrated state at ambient temperature. Preservon preservation technology eliminates the lengthy thawing and rehydrating times and does not require freezer storage. These plugs are available in sizes from 6 mm to 11 mm in diameter and 16 mm in length.

When selecting a graft for backfill applications, the implant should be sized 1 mm larger than the OATS core harvested. For example, in a case where an 8 mm OATS harvester is used, a 9 mm allograft plug is used to provide a line-to-line fit in the donor site.

An additional allograft plug delivery sleeve may be ordered to facilitate implantation of the plug.

Product Description	LifeNet Health Item Number
AlloPlug Frozen Backfill Plug w/ Cartilage, 7 mm	<b>FCPD7</b>
AlloPlug Frozen Backfill Plug w/ Cartilage, 8 mm	<b>FCPD8</b>
AlloPlug Frozen Backfill Plug w/ Cartilage, 9 mm	<b>FCPD9</b>
AlloPlug Frozen Backfill Plug w/ Cartilage, 10 mm	<b>FCPD10</b>
AlloPlug Frozen Backfill Plug w/ Cartilage, 11 mm	<b>FCPD11</b>

Product Description	LifeNet Health Item Number
FlexiGRAFT Cancellous Plug, 6 mm	<b>PCPD6</b>
FlexiGRAFT Cancellous Plug, 7 mm	<b>PCPD7</b>
FlexiGRAFT Cancellous Plug, 8 mm	<b>PCPD8</b>
FlexiGRAFT Cancellous Plug, 9 mm	<b>PCPD9</b>
FlexiGRAFT Cancellous Plug, 10 mm	<b>PCPD10</b>
FlexiGRAFT Cancellous Plug, 11 mm	<b>PCPD11</b>

Product Description	Item Number
Allograft Plug Delivery Sleeve, 7 mm (a)	<b>AR-1981BI-07</b>
Allograft Plug Delivery Sleeve, 9 mm	<b>AR-1981BI-09</b>
Allograft Plug Delivery Sleeve, 11 mm	<b>AR-1981BI-11</b>

Allowash XG, FlexiGRAFT, and Preservon are registered trademarks of LifeNet Health.

## Fresh Cartilage



Arthrex has a longstanding partnership with leading tissue banks to provide fresh osteochondral allografts (OCAs) for use in joint restoration procedures. Fresh OCAs allow the surgeon to transplant mature hyaline cartilage with viable chondrocytes and subchondral bone in a single procedure.

Product Description	JRF Ortho Part No.	LifeNet Health Part No.
<b>Upper Extremity/Shoulder</b>		
Humeral Head, right (a)	41247001	HHR80
Humeral Head, left	41247002	HHL80
<b>Elbow</b>		
Distal Humerus, right	44647001	
Distal Humerus, left	44647002	
Proximal Ulna, right	45847001	
Proximal Ulna, left	45847002	
<b>Lower Extremity/Hip</b>		
Femoral Head, right	41847001	FHR80
Femoral Head, left	41847002	FHL80

Product Description	JRF Ortho Part No.	LifeNet Health Part No.
<b>Knee</b>		
Medial Partial Hemi-Condyle, right	43647001	PCC80
Medial Partial Hemi-Condyle, left	43647002	PCB80
Lateral Partial Hemi-Condyle, right (b)	43747001	PCD80
Lateral Partial Hemi-Condyle, left (b)	43747002	PCA80
Medial Femoral Hemi-Condyle, right	32247001	FCC80
Medial Femoral Hemi-Condyle, left	32247002	FCB80
Lateral Femoral Hemi-Condyle, right (c)	32147001	FCD80
Lateral Femoral Hemi-Condyle, left	32147002	FCA80
Whole Femoral Condyle, right	33547001	FCR80
Whole Femoral Condyle, left	33547002	FCL80
Femoral Trochlea, right (d)	43547001	FTR80
Femoral Trochlea, left	43547002	FTL80
BiCompartment, right lateral and trochlea	43747003	FTD80
BiCompartment, left lateral and trochlea	43747004	FTA80
BiCompartment, right medial and trochlea	43647003	FTC80
BiCompartment, left medial and trochlea	43647004	FTB80
Medial Hemi-Tibial Plateau w/ Meniscus, right (e)	44947001	
Medial Hemi-Tibial Plateau w/ Meniscus, left	44947002	
Lateral Hemi-Tibial Plateau w/ Meniscus, right	45047001	
Lateral Hemi-Tibial Plateau w/ Meniscus, left	45047002	
Whole Tibial Plateau w/ Meniscus, right	32447001	TFR80
Whole Tibial Plateau w/ Meniscus, left	32447002	TFL80
Patella Bone w/ Attachment, right (f)	33647001	PARL80
Patella Bone w/ Attachment, left	33647002	PAL80
<b>Foot and Ankle</b>		
Distal Tibia, right (g)	32747001	TDR80
Distal Tibia, left	32747002	TDL80
Talus, right (h)	32647001	ATR80
Talus, left	32647002	ATL80
Proximal Metatarsal Bone, right	44747001	
Proximal Metatarsal Bone, left	44747002	
Distal Metatarsal Bone, right	44847001	
Distal Metatarsal Bone, left	44847002	

## Precut Fresh OCA Cores



Precut OCA cores provide a biologic and structural repair for full-thickness osteochondral lesions. OCA cores provide the optimal architecture, biomechanical support, and viable hyaline cartilage to support the repair during healing. The availability of fresh OCA cores now provides surgeons with a convenient new tool in their cartilage treatment regimen without the challenge of harvesting sufficient and suitable autologous donor cartilage.

The 16 mm allograft OATS® disposable kit contains an assortment of single-use instruments designed to prepare a 16 mm diameter socket through cartilage and subchondral bone. Paired with a 16 mm, fresh, precut osteochondral allograft from JRF Ortho or LifeNet Health, these instruments allow for quick preparation and implantation of viable and mature hyaline cartilage and bone.

Product Description	Arthrex Item Number	JRF Ortho Item Number	LNH Part Number
Precut Osteochondral Core, fresh, 10 mm		<b>45647010</b>	<b>RFP10</b>
Precut Osteochondral Core, fresh, 12 mm		<b>45647012</b>	<b>RFP12</b>
Precut Osteochondral Core, fresh, 16 mm		<b>45647016</b>	<b>RFP16</b>
Single-Use OATS Set, 16 mm (a)	<b>ABS-1981-16S</b>		

## Allograft OATS System

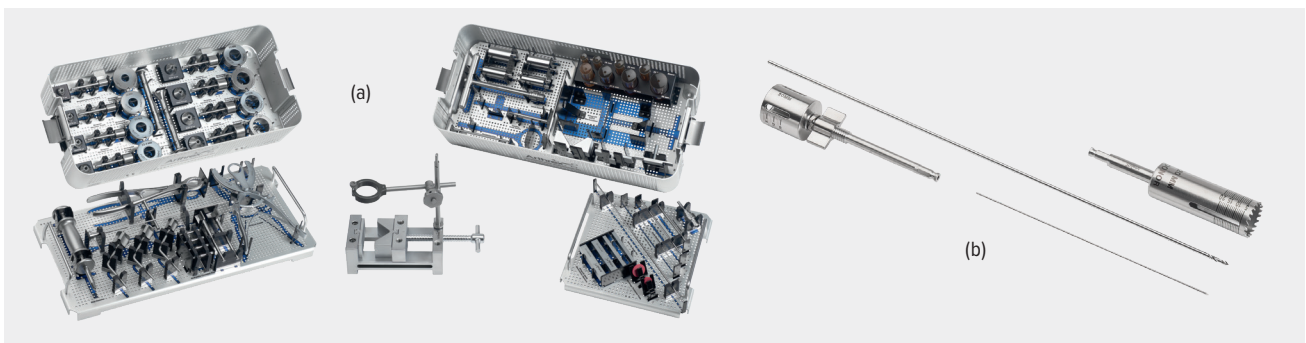

The allograft OATS system can be used for intraoperative harvesting of 15 mm to 35 mm diameter cores from fresh allografts.

media and maintained at 4° C. These grafts should be implanted as soon as possible to maintain the highest levels of viable chondrocytes.

There are few treatment options for patients with large symptomatic lesions of osteoarticular surfaces. Using allografts for osteoarticular resurfacing gives surgeons the ability to match the contour and cartilage morphology of the recipient site, while avoiding multiple surgical sites and the possible donor site morbidity associated with recovering an autograft from the knee. Fresh grafts are stored in a proprietary storage

Product Description	Item Number
Allograft OATS Instrument Set (a)	<b>AR-4058MS</b>
Allograft OATS Disposable Kit (b) Sizes: 15, 18, 20, 22.5, 25, 27.5, 30, 35 mm	<b>ABS-4057D-15 to -35</b>

The allograft OATS instrumentation set is made available when working with your Arthrex Technology Consultant to secure a fresh osteochondral allograft through an Arthrex tissue partner.

## BioUni® OCA Instrument Set



The BioUni OCA instrument set is the new standard for restoration of the articular surface when presented with elongated cartilage defects in the medial femoral condyle. Through a series of precisely designed cutting instruments, surgeons can replace damaged cartilage with a single, elliptical piece of viable hyaline cartilage.

The BioUni instruments address many of the challenges and risks associated with the recovery and implantation of multiple small and large cartilage cores. Overlapping multiple cores adds complexity of curve matching, fit, and surgical time for each procedure. The BioUni instruments were designed to match the natural curvature of the femoral condyle to remove those complexities. Multiple sizes allow flexibility for the surgeon to adjust the width and length of the cartilage defect and to ensure proper restoration of the articular surface with a single cartilage piece.

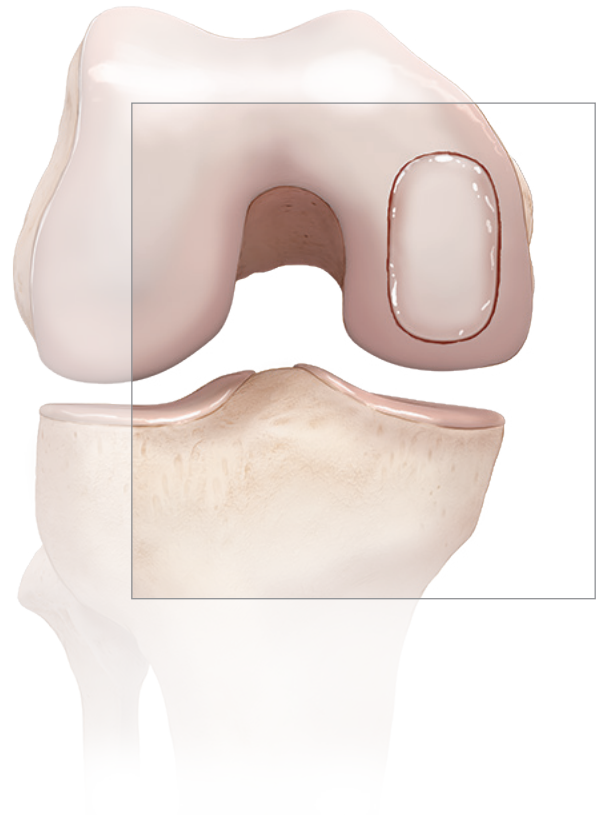

Product Description	Item Number
BioUni OCA Instrument Set (a)	AR-4058MS
BioUni Disposable Kit (b)	ABS-4080D
BioUni Cutting Kits Sizes: S14, S17, M14, M17, M20, L14, L17, L20, X17, X20	ABS-4080D-S14 to -X20

### Accessories

Product Description	Item Number
PowerPick™ Microfracture Instrument, 45°, 6 mm depth	AR-8150PX-45
PowerPick Microfracture Instrument, 30°, 4 mm depth	AR-8150PP-30
PowerPick Microfracture Instrument, 45°, 6 mm depth (5 pk)	AR-8150PP-45
Autologous Conditioned Plasma (ACP)	ABS-10010S
AlloSync™ Gel, 1 cc	ABS-2002-01
AlloSync Gel, 5 cc	ABS-2002-05



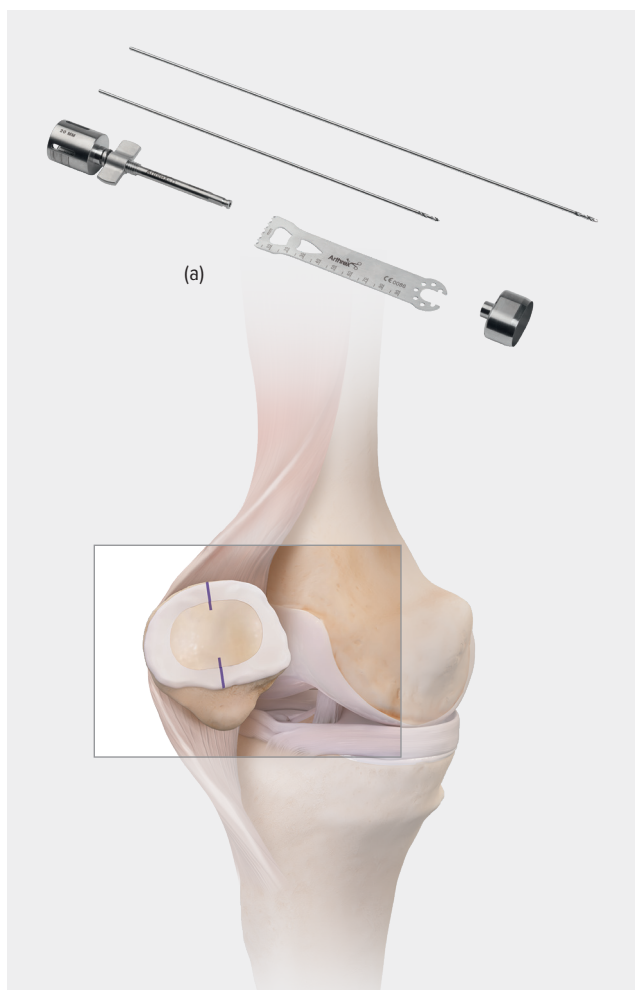

The BioPatella instrument set is the new standard for restoration of the articular surface of the patella when presented with oblong cartilage defects involving a significant amount of the patellar articular surface. Through a series of precisely designed cutting instruments, surgeons can replace damaged cartilage with a single, elliptical piece of viable, hyaline cartilage.

The BioPatella instruments address many of the challenges and risks associated with the recovery and implantation of standard smaller cylindrical cartilage cores. Positioning a standard round graft often does not suffice to adequately resurface the entirety of the injured articular surface. The BioPatella instruments were designed to match the natural curvature of the patella to resurface the entire functional articular surface. Multiple sizes allow flexibility for the surgeon to adjust the width and length of the cartilage defect and to ensure proper restoration of the articular surface with a single cartilage piece.

Product Description	Item Number
BioPatella Instrument Set, small, 20 mm × 30 mm (a)	ABS-4085D-S
BioPatella Instrument Set, medium, 25 mm × 35 mm	ABS-4085D-M
BioPatella Instrument Set, large, 27.5 mm × 37.5 mm	ABS-4085D-L

BioPatella instrumentation includes sizes small, medium, and large, each with an accompanying disposable kit.

Technique described by Thomas M. DeBerardino, MD (San Antonio, TX).



## Talus OATS® Instrumentation Set

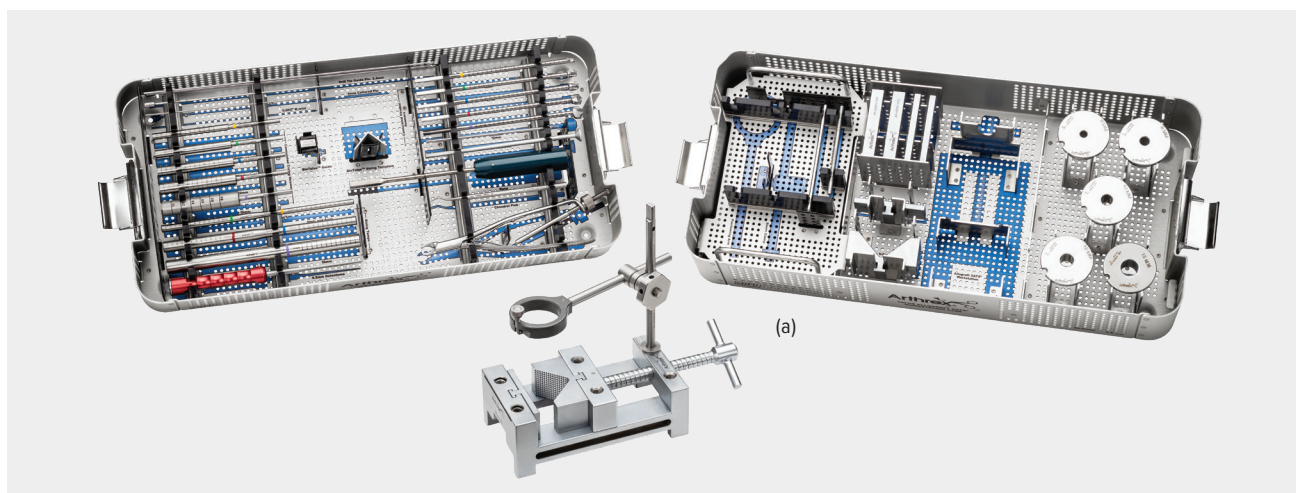

The Talus OATS instrumentation set facilitates harvesting of small-diameter (6 mm to 15 mm) osteochondral/hyaline cartilage cylinders from allograft bone. The core is made by placing the fresh talus into the workstation and harvesting it with the donor harvester. A recipient socket is created 0.5 mm undersized with the appropriately sized recipient harvester. The exact depth of the allograft, to match the socket, is obtained using the depth measurement guide and the allograft is trimmed to the same depth and

obliquity. Dilation of the socket results in a line-to-line fit once the donor allograft is inserted into the recipient socket. Final seating of the allograft is achieved with an oversized tamp, resulting in a perfectly flush, press-fit graft that does not require fixation implants.

Product Description	Item Number
Talus Allograft OATS Workstation and Instrumentation Set, 6 mm, 8 mm, 10 mm, 12 mm, 15 mm (a)	RAR-8901S

## Meniscus Allografts



Better understanding of the biomechanical consequences of total and partial meniscectomy has led surgeons to explore methods of meniscus preservation. However, in many cases, the damage is far too extensive to preserve the meniscus and few options exist for these patients.

Meniscal allografts have proven to be effective in improving function and reducing pain for selected patients with a meniscus-deficient knee. Arthrex can provide medial and lateral meniscal allografts that come with sufficient bone block to perform various anchorage procedures, including double-bone plug, keyhole, and dovetail techniques.

Meniscal allografts are most commonly used in symptomatic patients with prior meniscectomy and persistent pain. Patients should have normal alignment and should not have articular damage greater than grade III. Serious articular disease, osteophyte formation, or flattening of the femoral condyle are common contraindications for meniscal transplant.

Product Description	JRF Ortho Part No.	LifeNet Health Part No.
Lateral Meniscus, right	28325001	FMN RL
Lateral Meniscus, left	28325002	FMN LL
Medial Meniscus, right	28225001	FMN RM
Medial Meniscus, left	28225002	FMN LM

Meniscal allograft tissue is also available upon request for non-knee transplantation such as carpometacarpal or metatarsophalangeal joint procedures.

## Meniscal Implantation Techniques

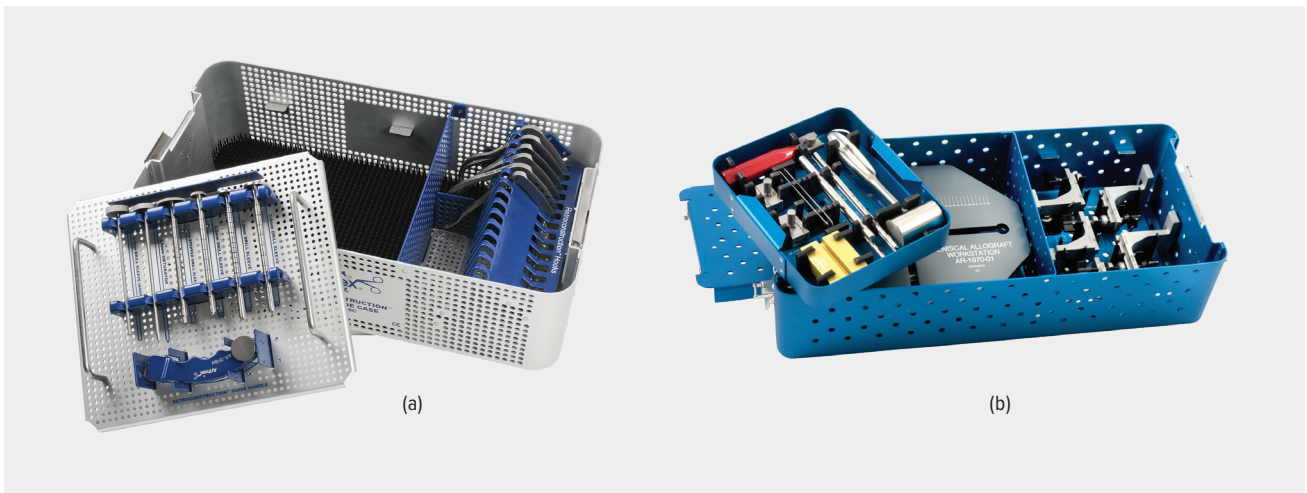

Meniscal allografts have been found to be a feasible alternative in the effort to limit sequelae of arthritis that can occur with meniscal excision.<sup>33</sup> The surgical technique for meniscal allograft transplantation of the knee continues to evolve.

Simplified graft preparation and recipient tibia preparation—to allow for the transplant to be positioned anatomically and anchored with reliable fixation—is the ultimate goal of the procedure.

### Double-Bone Plug Meniscal Reconstruction

The double-bone plug technique for meniscal allograft reconstruction provides a method for implanting the meniscal allograft with rigid fixation at the horn attachments. It has been demonstrated that bony fixation at the attachment site allows for the maintenance of functional hoop stress by the meniscal allograft.<sup>33</sup>

### Dovetail Meniscal Reconstruction

The dovetail technique simplifies graft preparation with a time-saving series of cuts preparing the bone component of the graft to sit securely in the recipient semitrapezoidal slot created in the tibia. A matching semitrapezoidal recipient slot created in the tibia with a series of step drills, rasps, and dilators matches the bone block preparation.

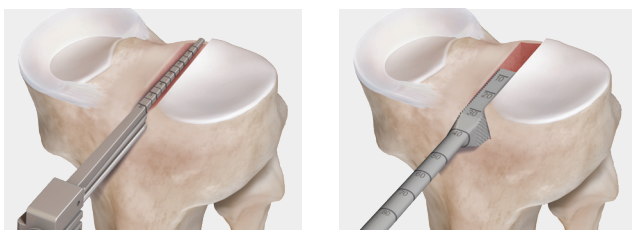

A “box” technique that requires an interference screw fixation is also available.

Product Description	Item Number
RetroConstruction™ Drill Guide Set (a)	AR-1510S
Dovetail Meniscal Allograft Instrumentation Set (b)	AR-1970S

The dovetail meniscal allograft instrumentation set is made available when working with your Arthrex Technology Consultant to secure a meniscus allograft.

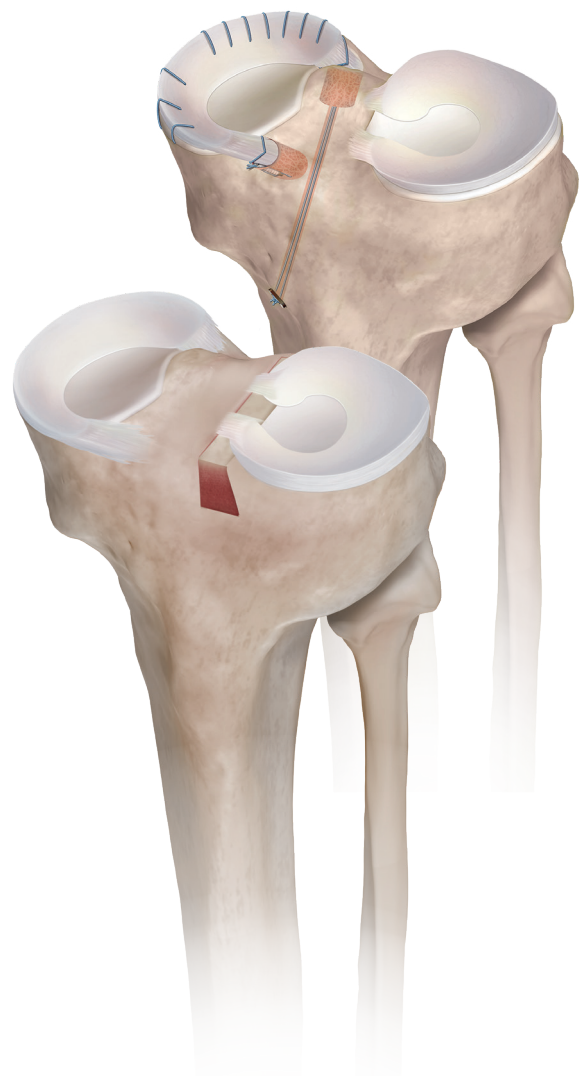

## Segmental Meniscus Transplant



Segmental meniscus is a meniscus preservation option for prior failed repairs, partially meniscectomized and/or non-repairable meniscus with intact roots. The allograft meniscus can be appropriately sized to the patient's defect area to maintain the intact portions of the meniscus, such as the meniscal roots.

### Features and Benefits<sup>34</sup>:

- Intact portions of the meniscus are maintained
- Restoration of joint contact pressure when the segmental defect is restored
- Preserved mechanoreceptors within the native meniscus may improve proprioception and joint homeostasis
- Segmental meniscus transplant is firmly secured with suture anchors at the junction of allograft-to-native meniscus

Product Description	JRF Ortho Part No.	LifeNet Health Part No.
Lateral Meniscus, right	28325001	FMN RL
Lateral Meniscus, left	28325002	FMN LL
Medial Meniscus, right	28225001	FMN RM
Medial Meniscus, left	28225002	FMN LM

Product Description	Item Number
ZoneNavigator™ System Handle	AR-7900
ZoneNavigator System Anterior Cannula	AR-7905
ZoneNavigator System Middle Cannula, left posterior	AR-7910L
ZoneNavigator System Middle Cannula, right posterior	AR-7910R
Knee Scorpion™ Suture Passer	AR-12990
FiberStitch™ Implant, curved	AR-4570
FiberStitch Implant, 24° curve	AR-4570-24
FiberStitch Implant, reverse curve	AR-4570R
FiberStitch Implant, straight	AR-4570S

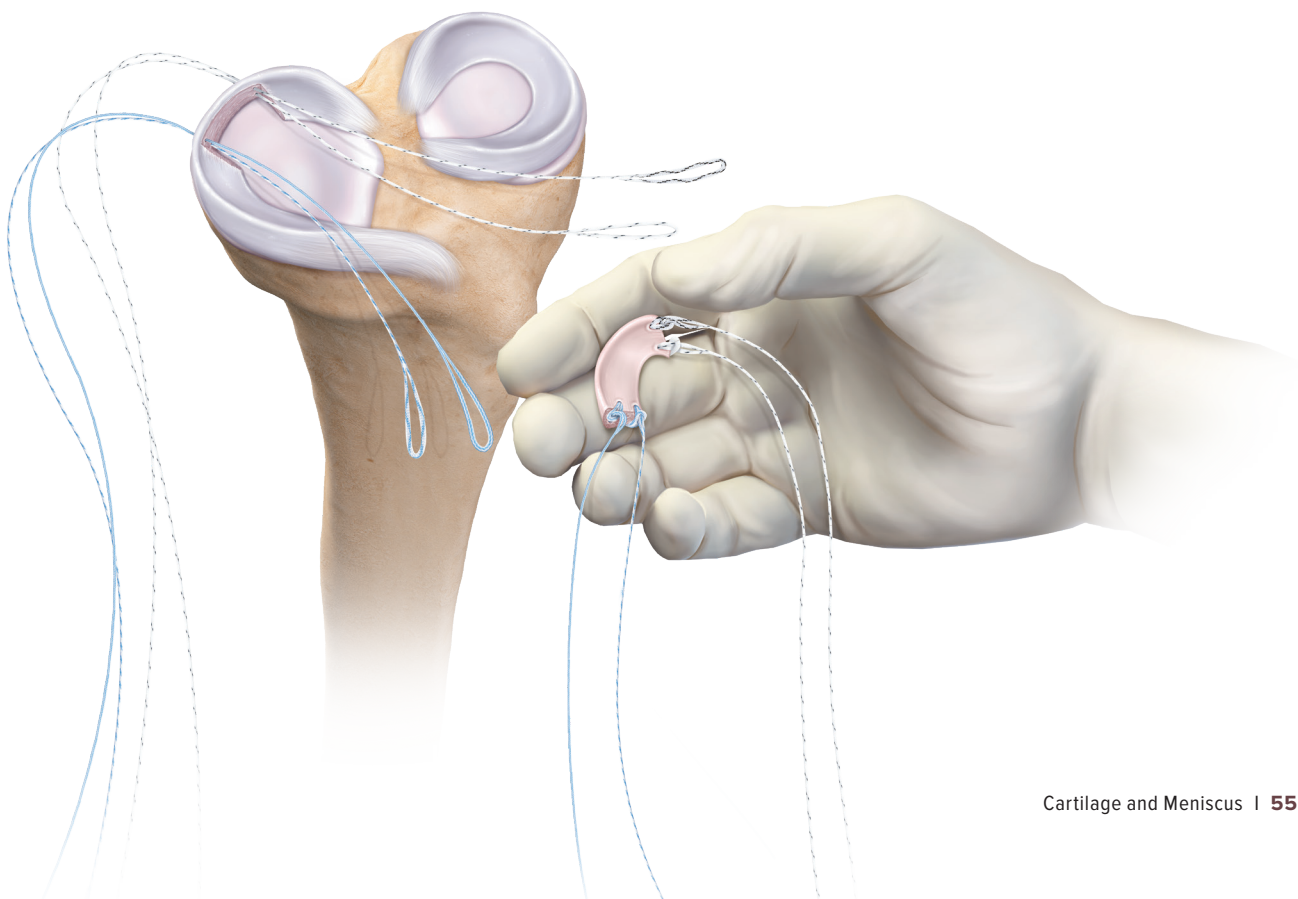



## IntraOsseous BioPlasty® (IOBP®) System

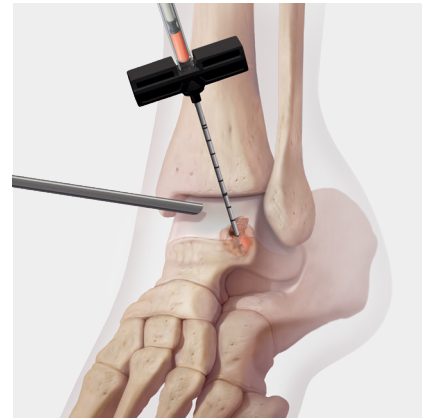
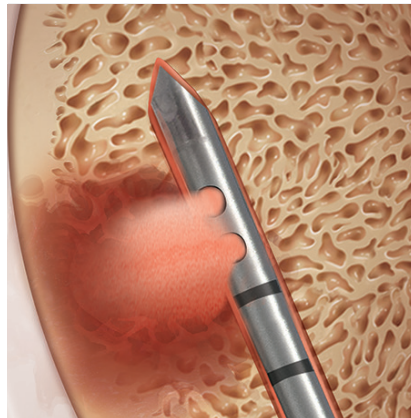
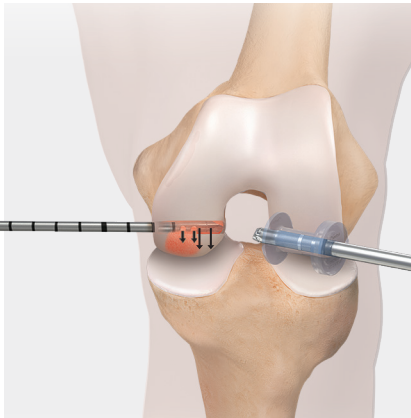

The IntraOsseous BioPlasty (IOBP) surgical technique is for the treatment of bone pathologies resulting from acute or chronic injury, including bone marrow lesions associated with insufficiency fractures, persistent bone bruises, osteoarthritis, and early stages of avascular necrosis. Arthrex offers a biologic option for the treatment of these pathologies by performing a core decompression of the lesion and a direct application of cPRP from BMA using the Angel® cPRP and bone marrow processing system.

A recently published prospective clinical trial looked at 20 patients with symptomatic bone marrow lesions (BML) that had failed conservative treatment and were indicated for the IOBP procedure. The authors mixed AlloSync™ Pure demineralized bone matrix with cPRP from BMA using the Angel system to deliver the mixture to the BML. The authors concluded that biologic treatment of BML is an “effective adjunct to arthroscopy that provides short-term pain relief for BMLs associated with degenerative conditions of the knee. This procedure is associated with clinically significant improvements in knee pain and function over a short-term follow-up.”<sup>35</sup>

Additionally, research has shown the positive clinical outcomes of treating BMLs and persistent bone fractures, or nonunions, with bone marrow concentrate.<sup>33</sup> Clinical outcomes from another study indicate pain and function improve following intraosseous delivery of a biologic into BMLs associated with osteoarthritis.<sup>37</sup>

The IOBP procedure is the biologic treatment of BMLs with techniques that encourage physiologic bone remodeling and repair.

Note: AlloSync Pure DBM or AlloSync gel, provided separately, may be mixed with the autologous blood solution.

Concentration of Stem Cells in Bone Graft Affect Outcome<sup>36</sup>

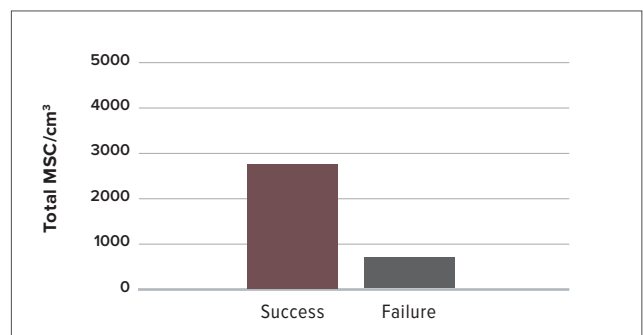

Clinical Outcomes When Treating Osteoarthritis<sup>37</sup>

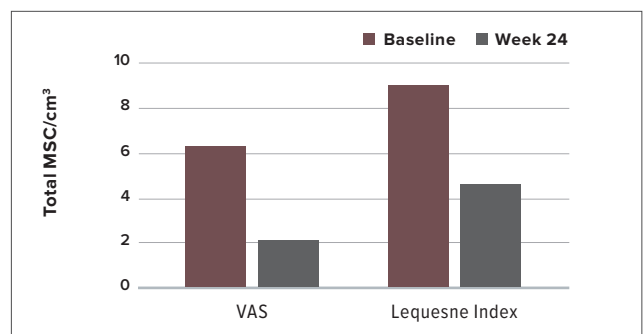

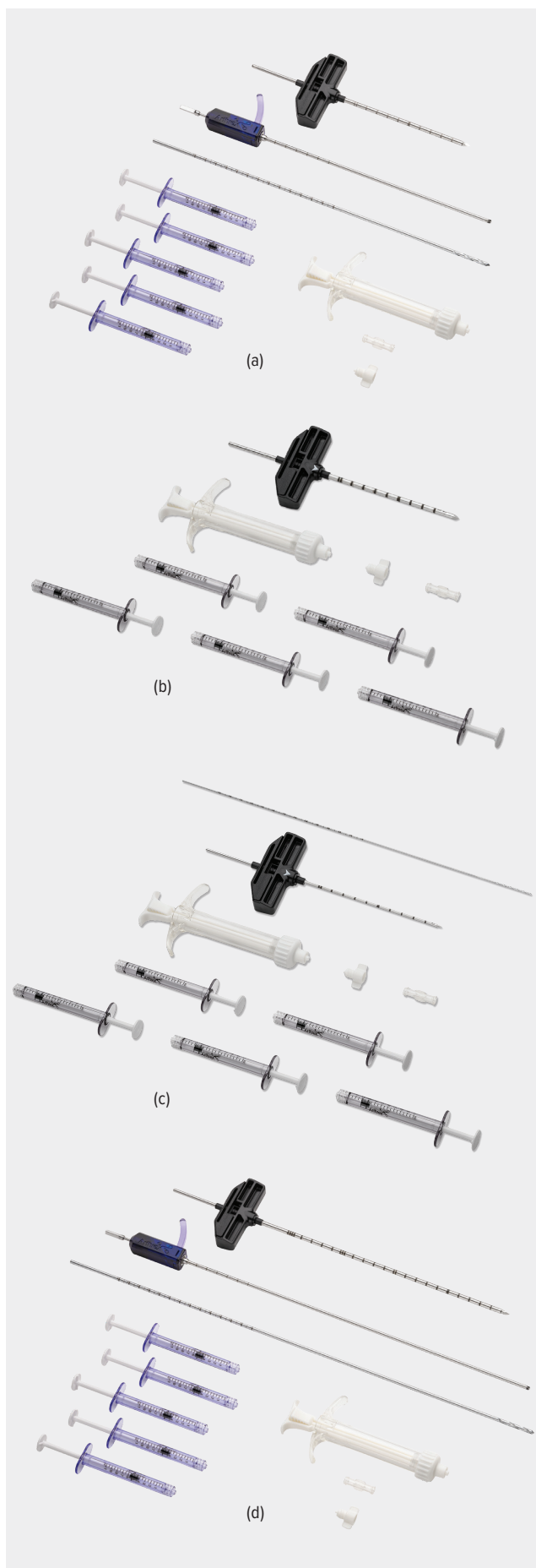

Knee IOBP® Procedures

Product Description	Item Number
IOBP Core Decompression and Delivery Kit, open tip (a)	ABS-2001-OT
Includes: open-tip 8 ga × 11 cm delivery cannula, 14 cc mixing syringe, 2.4 mm guide pin, 7 mm decompression device, Luer cap, female-to-female Luer adaptor, 5 × 1 cc delivery syringes	
IOBP Core Decompression and Delivery Kit, closed tip (b)	ABS-2000-CT
Includes: closed-tip 8 ga × 11 cm delivery cannula, 14 cc mixing syringe, 5 × 1 cc delivery syringes, Luer cap, female-to-female Luer adaptor	

Foot and Ankle IOBP Procedures

Product Description	Item Number
IOBP Core Decompression and Delivery Kit, foot and ankle (c)	ABS-2020-OT
Includes: open-tip 13 ga × 11 cm delivery cannula, 14 cc mixing syringe, 1.5 mm	

Hip IOBP Procedures

Product Description	Item Number
IOBP Delivery Kit w/ Decompression Device, open tip (d)	ABS-2010-OT
Includes: open-tip 8 ga × 23 cm delivery cannula, 7 mm IOBP decompression device, 14 cc mixing syringe, 3.3 mm guide pin, 5 × 1 cc delivery syringes, Luer cap, female-to-female Luer adaptor	
IOBP Core Decompression and Delivery Kit, closed tip	ABS-2010-CT
Includes: closed-tip 8 ga × 23 cm delivery cannula, 14 cc mixing syringe, 5 × 1 cc delivery syringes, Luer cap, female-to-female Luer adaptor	

Accessories

Product Description	Item Number
Angel® cPRP and BMA Tray	ABS-10062T
Viscous-Spray™, low viscosity applicator w/ 3 cm mixing tip	ABS-10051
Delivery Cannula, 8 ga × 4.5 in, closed tip	RAN-811-CT
Delivery Cannula, 8 ga × 6 in, open tip	RAN-815-OT
Delivery Needle, 13 ga × 4.5 in, open tip (foot and ankle applications)	RAN-1311H-OT
Delivery Cannula, 8 ga × 9 in, open tip (hip applications)	RAN-823-OT
Delivery Cannula, 8 ga × 9 in, closed tip (hip applications)	RAN-823-CT
RetroConstruction™ Drill Guide (knee applications)	ABS-1510HR
Marking Hook, femoral AC (knee applications)	ABS-1510F-01
GPS-Targeting Drill Guide Set (foot and ankle applications)	AR-8656GS
AlloSync™ Pure DBM, 2.5 cc	ABS-2010-02
AlloSync Pure DBM, 5 cc	ABS-2010-05
AlloSync DBM Gel, 5 cc	ABS-2013-05
Radiopaque Contrast	N/A





# Soft Tissue

ArthroFLEX Dermal Allograft .....	60
CuffMend™ Rotator Cuff Augmentation Using ArthroFLEX® Dermal Allograft .....	61
Biologic Tuberoplasty Augmentation.....	62
GraftNet™ Autologous Tissue Collector for Soft Tissue.....	63
Arthrex Amnion™ Matrix .....	64
AmnionXpress™ Graft Delivery Device.....	65
Tendon Allografts—Construct Grafts .....	66
Biovance® Human Amniotic Membrane .....	67
CentaFlex™ Decellularized Human Placental Matrix .....	68
Interfyl® Human Connective Tissue Matrix.....	69
Tendon Allografts—Standard Grafts.....	70
Aseptic Tendons .....	71

## ArthroFLEX® Dermal Allograft

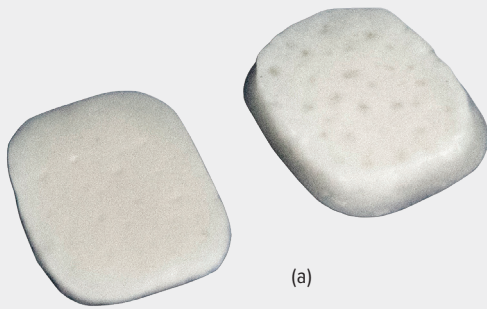

(a)

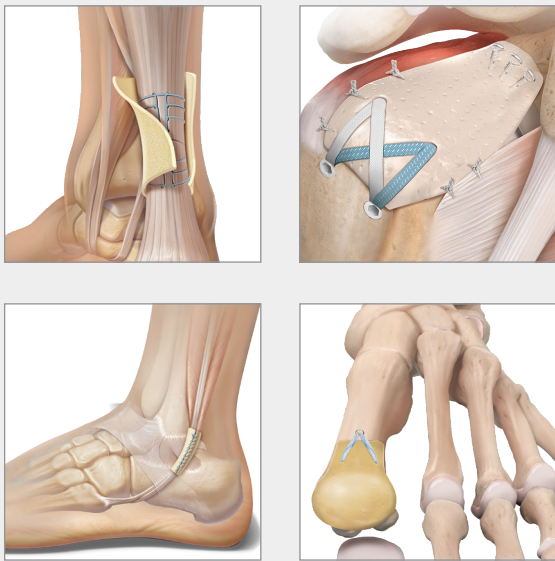

ArthroFlex dermal allograft is an acellular dermal extracellular matrix intended for supplemental support and covering for soft-tissue repair. MatrACELL® technology, a patented and validated process by LifeNet Health, renders the ArthroFlex allograft dermis acellular, without compromising biomechanical or biochemical properties. This process allows the matrix to retain its growth factors, native collagen scaffold, and elastin, which are required for healing.

- An intact acellular matrix of collagen, elastin, and growth factors provides a clean scaffold intended for supplemental support and covering for soft-tissue repair
- Elastin and collagen provide unparalleled strength for supplemental support and covering for soft-tissue repair
- Short processing time reduces the opportunity for water-mediated lysis of the natural collagen and elastin scaffold
- MatrACELL technology removes donor DNA from the dermal matrix, ensuring a biocompatible scaffold to facilitate repair
- Uses a validated DNA assessment method, able to detect as little as 1 ng/mL of nucleic acid to ensure the tissue has been decellularized
- Uses multiple disinfecting agents to provide comprehensive tissue disinfection
- Terminally sterilized with a 3-year shelf life

Product Description	LifeNet Health Part No.
Decellularized Dermis, 35 mm × 35 mm × 1.5 mm	<b>AFLEX100</b>
Decellularized Dermis, 40 mm × 70 mm × 1.5 mm	<b>AFLEX101</b>
Decellularized Dermis, 50 mm × 90 mm × 1.5 mm	<b>AFLEX103</b>
Decellularized Dermis, 15 mm × 140 mm × 1.5 mm	<b>AFLEX150</b>
Decellularized Dermis, 35 mm × 35 mm × 2.0 mm	<b>AFLEX200</b>
Decellularized Dermis, 40 mm × 70 mm × 2.0 mm	<b>AFLEX201</b>
Decellularized Dermis, 25 mm × 30 mm × 2.0 mm	<b>AFLEX202</b>
Decellularized Dermis, 40 mm × 50 mm × 3.0 mm	<b>AFLEX300</b>
Decellularized Dermis, 40 mm × 70 mm × 3.0 mm	<b>AFLEX301</b>
Decellularized Dermis, 50 mm × 60 mm × 3.0 mm	<b>AFLEX302</b>
Decellularized Dermis, 40 mm × 40 mm × 1.0 mm	<b>AFLEX400</b>
Decellularized Dermis, 40 mm × 70 mm × 1.0 mm	<b>AFLEX401</b>
Decellularized Dermis, 20 mm × 25 mm × 1.0 mm	<b>AFLEX402</b>
Decellularized Dermis, 25 mm × 30 mm × 1.0 mm	<b>AFLEX403</b>
Decellularized Dermis, 30 mm × 40 mm × 0.5 mm	<b>AFLEX500</b>
BioWasher® Decellularized Dermis, 10 mm × 14 mm × 2.0 mm (a)	<b>AFLEX822</b>

Product Description	LifeNet Health Part No.
Decellularized Dermis, 20 mm × 30 mm × 4 mm	<b>AFLEX602</b>
Decellularized Dermis, 25 mm × 35 mm × 4 mm	<b>AFLEX600</b>
Decellularized Dermis, 40 mm × 70 mm × 5 mm	<b>AFLEX651</b>

ArthroFlex, MatrACELL, and BioWasher are registered trademarks of LifeNet Health



## CuffMend™ Rotator Cuff Augmentation Using ArthroFLEX® Dermal Allograft

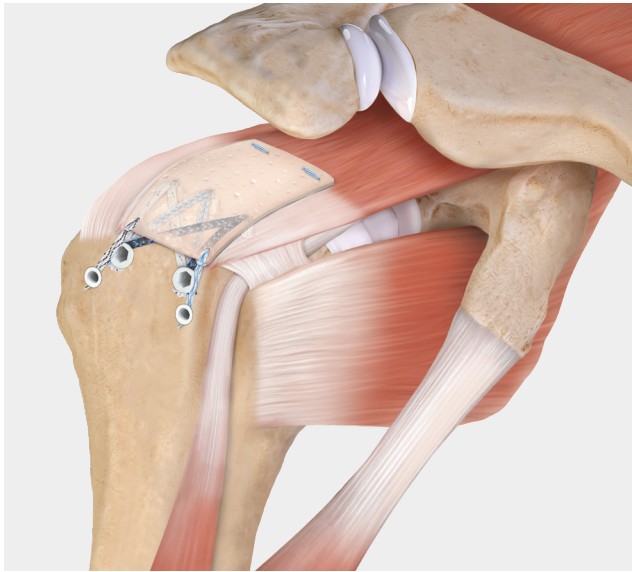

The CuffMend rotator cuff augmentation system provides tried and true biocompatibility with ArthroFlex decellularized dermal allograft, and innovative and secure fixation with the FiberStitch™ implant to provide a biologic augmentation for full-thickness and partial-thickness rotator cuff tears.

### Features and Benefits:

- Presized extracellular human dermal matrix provides support and covering to the rotator cuff
- LifeNet Health's MatrACELL® process removes ≥97% of DNA without compromising biomechanical and biochemical properties
- Demonstrated ability to remodel and integrate with host tissue,<sup>38</sup> decrease retear rates, and improve patient outcomes
- Bony fixation using 3.5 mm BioComposite PushLock® anchors

Product Description	Item Number
Decellularized Dermis, 20 mm × 25 mm × 1 mm	<b>AFLEX402</b>
Decellularized Dermis, 25 mm × 30 mm × 1 mm	<b>AFLEX403</b>
Decellularized Dermis w/ MatrACELL, 25 mm × 30 mm	<b>AFLEX202</b>
Graft Spreader	<b>AR-19007GS</b>
FiberStitch RC Implant, curved	<b>AR-19031C</b>
FiberStitch RC Implant, straight	<b>AR-19031S</b>

## Biologic TuberoPlasty Augmentation

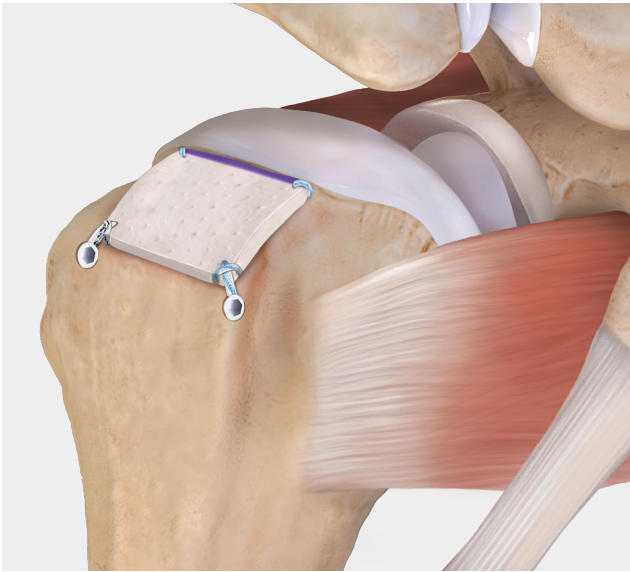

Biologic tuberoPlasty harnesses the power of ArthroFlex dermal allograft to provide a permanent spacer between acromion and tuberosity, preventing bone-on-bone contact in irreparable rotator cuff tears. Self-punching tensionable knotless technology allows the ArthroFlex graft to be placed in a quick, effective, and reproducible technique to help prevent shoulder impingement syndrome,<sup>39</sup> which is often associated with shoulder pain.

Product Description	Item Number
<b>Implants</b>	
Decellularized Dermis, 20 mm × 30 mm × 3 mm	<b>AFLEX352</b>
Knotless 2.6 FiberTak® SP Anchor w/ #5 Suture, self-punching	<b>AR-3641SP</b>
BioComposite SwiveLock® SP Anchor, 4.75 mm × 24.5 mm w/ 1.3 mm SutureTape (white/blue), self-punching PEEK eyelet	<b>AR-2324BCSP</b>
<b>Optional Implants</b>	
Knotless BioComposite SwiveLock SP, 4.75 mm × 24.5 mm w/ #2 suture (blue), self-punching PEEK eyelet	<b>AR-2324KBCSP</b>
Knotless BioComposite SwiveLock SP Anchor, 4.75 mm × 24.5 mm w/ #2 suture (blue), self-punching PEEK eyelet	<b>AR-2324KPSP</b>
PEEK SwiveLock SP Anchor, 4.75 mm × 24.5 mm w/ 1.3 mm SutureTape, self-punching PEEK eyelet	<b>AR-2324PSP</b>
<b>Bone Preparation</b>	
PowerRasp™ Instrument, 5.5 mm × 13 cm	<b>AR-8550PR</b>
PowerPick™ Instrument, 45°, 6 mm drill depth	<b>AR-8150PX-45</b>
<b>Other</b>	
Arthroscopic Measurement Probe, 60°, 220 mm	<b>AR-4070-01</b>
SCR Guide	<b>AR-16950SR</b>
Back Grasper w/ SR Handle	<b>AR-12531SR</b>
PassPort Button™ Cannula, 12 mm I.D. × 3 cm	<b>AR-6592-12-30</b>
PassPort Button Cannula, 12 mm I.D. × 4 cm	<b>AR-6592-12-40</b>
PassPort Button Cannula, 12 mm I.D. × 5 cm	<b>AR-6592-12-50</b>
12 mm PassPort Inserter	<b>AR-6592-12PI</b>
PassPort Divider, 12 mm	<b>AR-6592-12D</b>
FiberLink™ SutureTape, 1.3 mm, w/ loop (white/blue)	<b>AR-7535</b>
TigerLink™ SutureTape, 1.2 mm, w/ loop (white/black)	<b>AR-7535T</b>

## GraftNet™ Autologous Tissue Collector for Soft Tissue

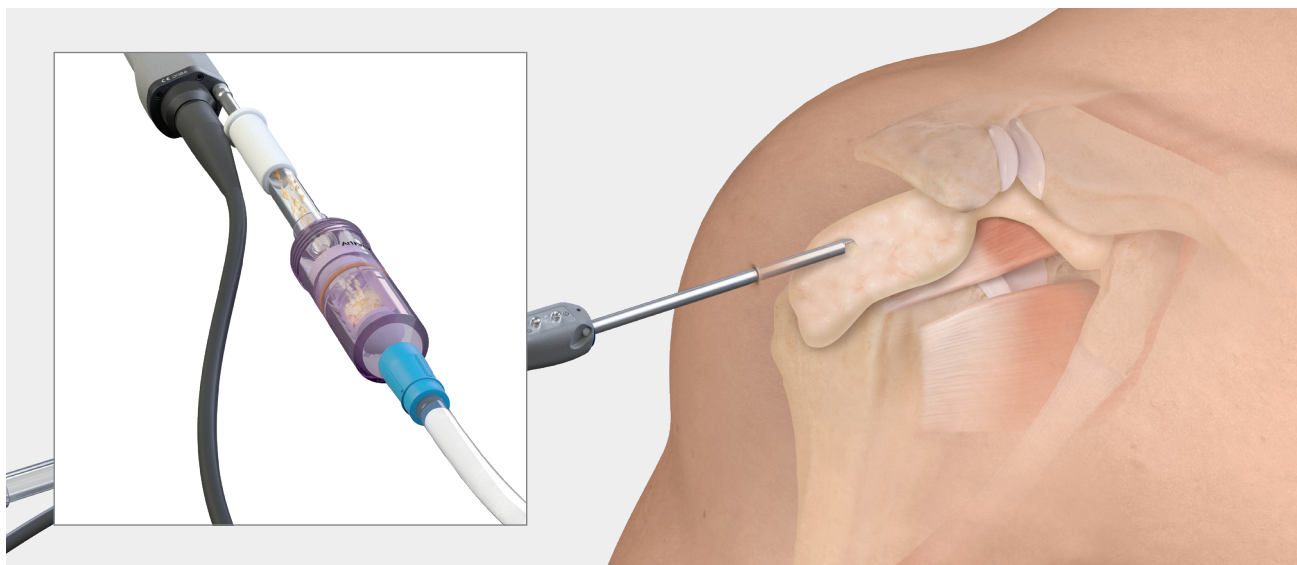

The suction-activated GraftNet device is designed to collect autologous tissue for a multitude of applications. When connected to an arthroscopic shaver, the GraftNet device may be used to remove tissue debris, soft tissue, or cartilage from a surgical site. This recovered autologous tissue is collected in an easily accessed, sterile filtered chamber. The GraftNet autologous tissue collector makes gaining access to autograft tissue as simple as Resect and Collect™.

- Universal adapters make for easy assembly
- Collect autologous bone, cartilage, or soft tissue
- Quickly access recovered tissue volume
- Control the particulate size when using a shaver device

### Soft-Tissue Applications

- Subacromial bursa during rotator cuff repair, remnant stump during ACL reconstruction, or other soft-tissue structures may be recovered and used in various procedures
- The presence of a potential soft-tissue or wound infection often requires collecting a sample of the affected tissue
- The GraftNet tissue collector allows for simple and effective collection of resected tissue into a sterile, closed device

Product Description	Item Number
GraftNet Autologous Tissue Collector	ABS-1050

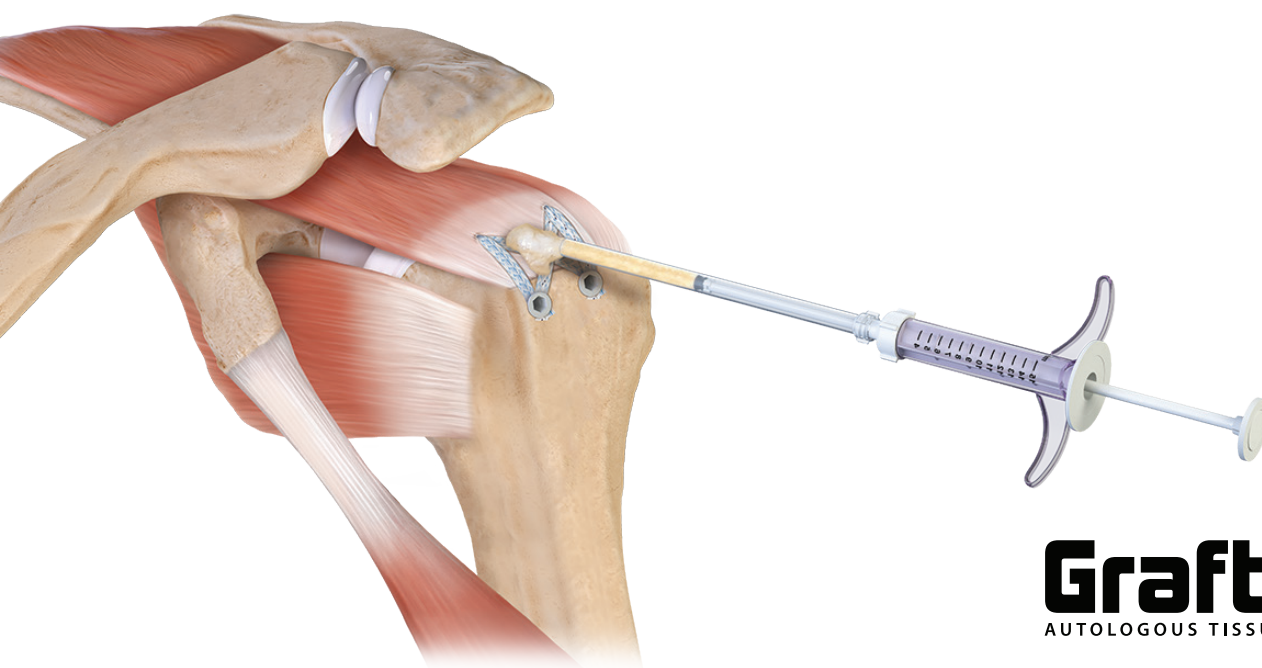

**GraftNet™**  
AUTOLOGOUS TISSUE COLLECTOR





(a)

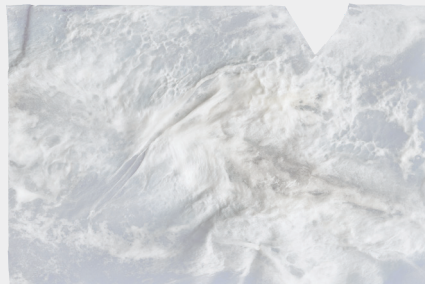

(b)

Amniotic-derived tissues contain endogenous growth factors and cytokines that maintain the natural properties of amnion. Arthrex Amnion matrix is an anatomical barrier that helps provide mechanical protection<sup>40</sup> while supporting tissues with nutrient-rich growth factors.

- Protection: used as an anatomical wrap to act as a natural barrier (for homologous use only)
- Easy to use: membranes are rehydrated quickly in the surgical site
- Convenient: ambient storage (membranes) with a 5-year shelf life
- Safe: immuno-privileged

#### Features and Benefits:

- Natural structural barrier
- Rich in growth factors and cytokines

Arthrex Amnion matrix extracellular membrane is available in 2 thicknesses and a variety of sizes.

#### Arthrex Amnion Matrix - Thin

This traditional single layer is a semitransparent collagenous membrane approximately 100 µm to 300 µm in thickness. As with the thicker version, Arthrex Amnion Matrix - Thin is intended for use as a soft-tissue barrier or wound covering.

#### Arthrex Amnion Matrix – Thick

Approximately 8× thicker than traditional amnion, Arthrex Amnion Matrix - Thick can be sutured and is easy to handle. Arthrex Amnion Matrix - Thick is derived from the umbilical cord.

#### Arthrex Amnion Matrix

Product Description	Item Number
<b>Arthrex Amnion Matrix – Thin</b>	
2 cm × 2 cm	ABS-4100-022
2 cm × 3 cm	ABS-4100-023
4 cm × 4 cm	ABS-4100-044
4 cm × 6 cm	ABS-4100-046
7 cm × 7 cm	ABS-4100-077
<b>Arthrex Amnion Matrix – Thick</b>	
2 cm × 2 cm	ABS-4200-022
2 cm × 3 cm	ABS-4200-023
2 cm × 4 cm	ABS-4200-034
2 cm × 6 cm	ABS-4200-036
2 cm × 8 cm	ABS-4200-038
5.5 cm × 4 cm	ABS-4200-054



## AmnionXpress™ Graft Delivery Device

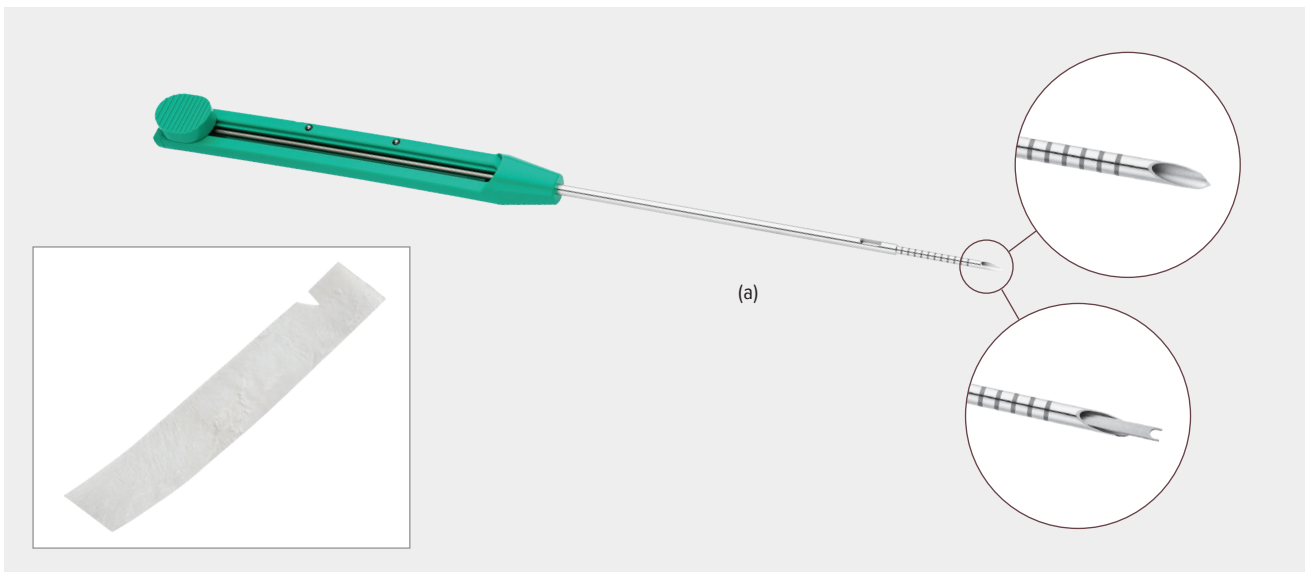

The AmnionXpress delivery device is designed for targeted delivery of soft tissue to an orthopedic surgical site. The 5 mm × 40 mm strip of Arthrex Amnion™ matrix and the 0.5 cm × 4 cm CentaFlex™ placental matrix are specifically designed for the AmnionXpress delivery device for a variety of applications, such as rotator cuff repair, ACL reconstruction and repair, Achilles repair, and patellar tendon injuries.

Product Description	Item Number
AmnionXpress Delivery Device	ABS-4400
Amnion Matrix - Thick, 5 mm × 40 mm	ABS-4200-054
CentaFlex Placental Matrix, 0.5 cm × 4 cm	HPM-0054

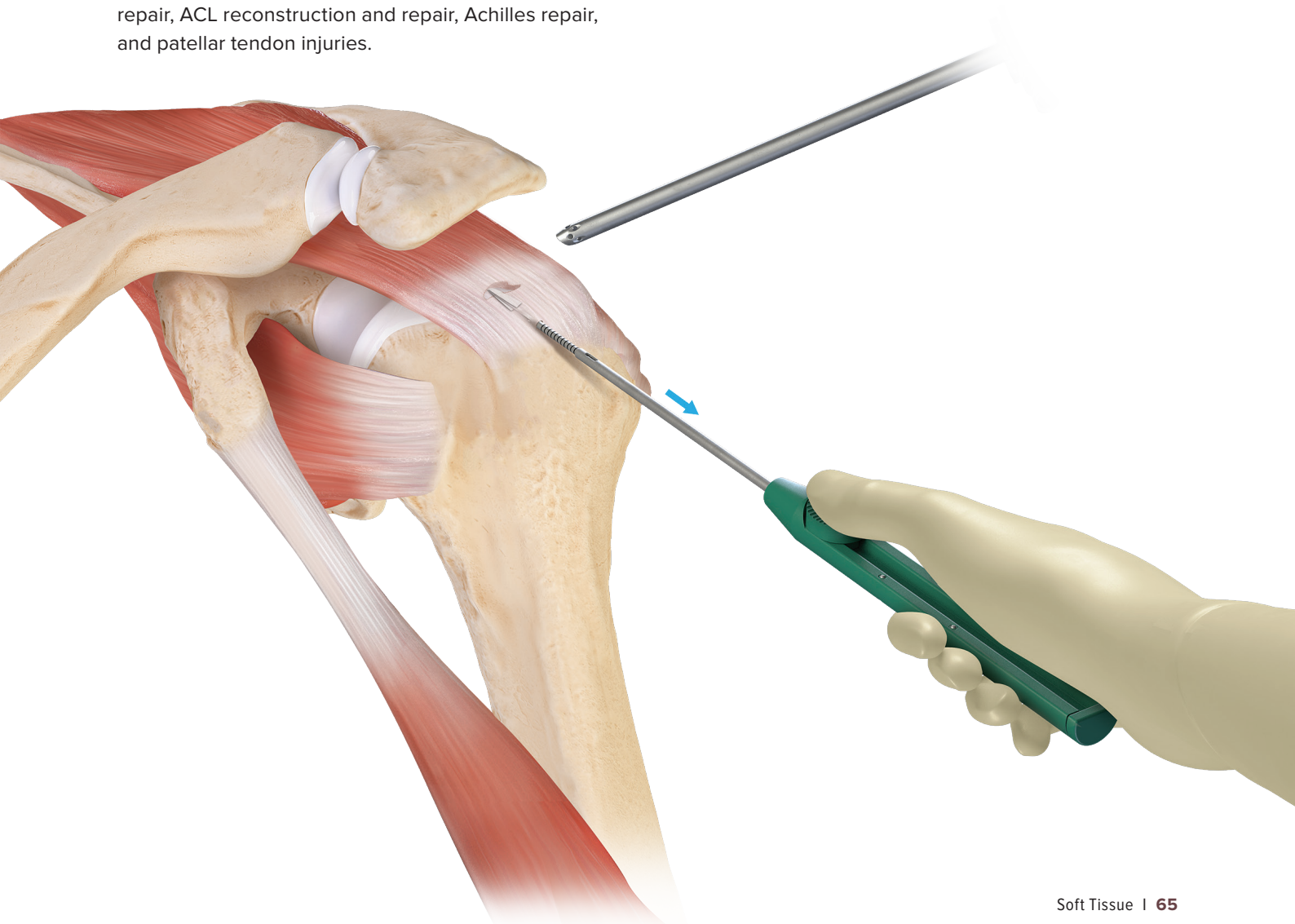

## Tendon Allografts—Construct Grafts

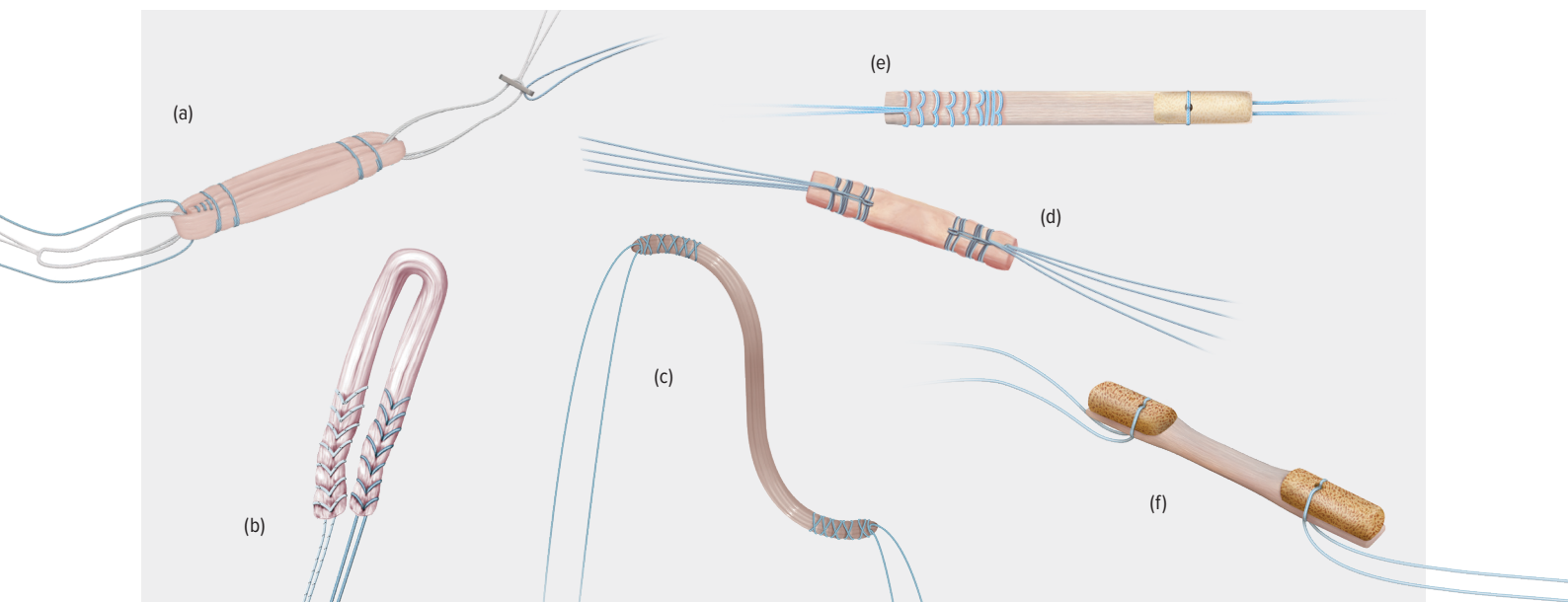

Arthrex offers a variety of presutured tendon allografts for ligament reconstruction procedures, such as ACL, PCL, ALL, MPFL, and lateral ankle procedures. These tendons are preassembled by qualified tissue technicians for consistency. Presutured tendons are terminally sterilized under low-dose, low-temperature conditions for patient safety.

The use of an allograft eliminates donor site morbidity and pain associated with the recovery of autologous tissue. The convenience of a presutured tendon allows for an off-the-shelf solution with minimal preparation time.

### Construct Grafts

Product Description	JRF Ortho Part No.	LifeNet Health Part No.
GraftLink® Presutured Construct (a)		<b>FGL</b>
GraftLink TS Presutured Construct		<b>FGLTS</b>
DualLink™ Presutured Construct		<b>FDL</b>
FlexiGRAFT® Connect Tendon		<b>FCON</b>
FlexiGRAFT Connect EXT		<b>FCONEXT</b>
QuadLink® Presutured Tendon (d)		<b>FQL</b>
GraftLink XL Construct (PCL)	<b>GRX-001</b>	
SpeedGraft® Construct (b)	<b>SPD-001</b>	
VersaGraft® Construct (c)	<b>VRG-001</b>	
VersaGraft 3.5 Construct	<b>VRG-351</b>	
SpeedGraft Achilles Tendon (e)	<b>PSA-101</b>	
PilotGraft™ BTB Tendon (f)	<b>PSP-101</b>	

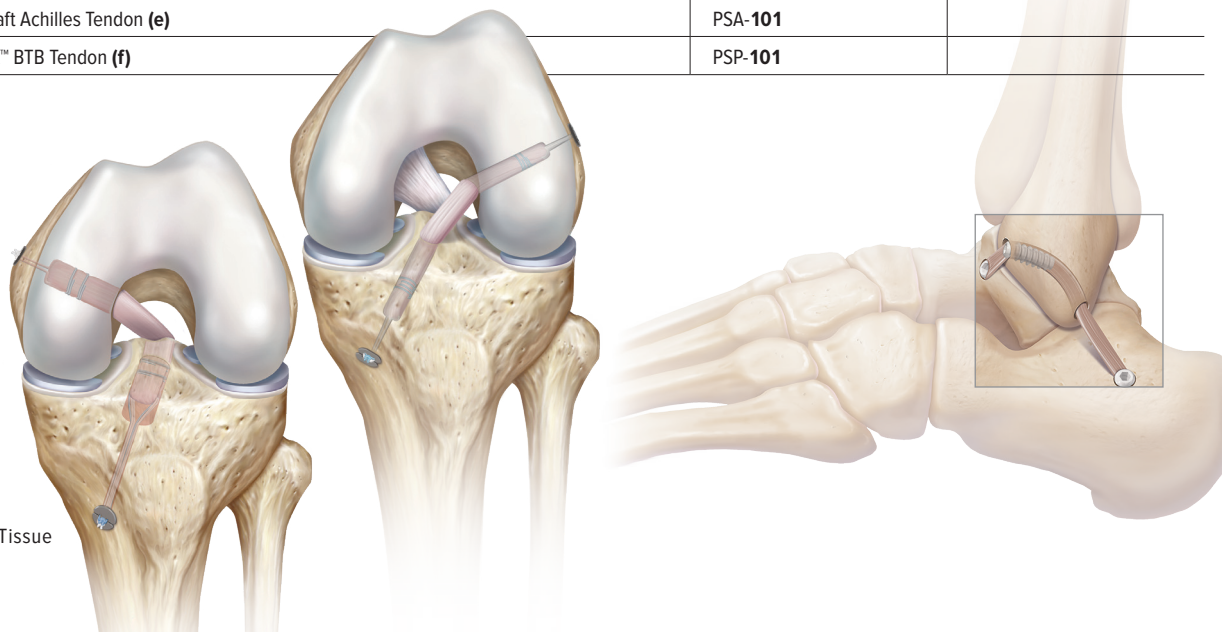

## Biovance® Human Amniotic Membrane



Biovance human amniotic membrane supports tissue restoration. Biovance serves as a natural scaffold with an intact basement membrane that has been found to support a high level of fibroblast and keratinocyte attachment.<sup>41</sup>

Designed for ease of use in surgical and nonsurgical settings, Biovance membrane offers the following features and benefits:

- Requires no preparation
- Can be applied in any orientation
- Requires no sutures
- Room temperature storage
- 10-year shelf-life

Product Description	Item Number
Biovance Amniotic Membrane, 1 cm × 2 cm	<b>DHAM0012</b>
Biovance Amniotic Membrane, 2 cm × 2 cm	<b>DHAM0022</b>
Biovance Amniotic Membrane, 2 cm × 3 cm	<b>DHAM0023</b>
Biovance Amniotic Membrane, 2 cm × 4 cm	<b>DHAM0024</b>
Biovance Amniotic Membrane, 3 cm × 3.5 cm	<b>DHAM0035</b>
Biovance Amniotic Membrane, 4 cm × 4 cm	<b>DHAM0044</b>
Biovance Amniotic Membrane, 5 cm × 5 cm	<b>DHAM0055</b>
Biovance Amniotic Membrane, 6 cm × 6 cm	<b>DHAM0066</b>

Study found a statistically significant decrease in cases of incisional dehiscence with the use of Biovance.<sup>42</sup>

Primary Endpoint:  
Complications of Wound Dehiscence (%)

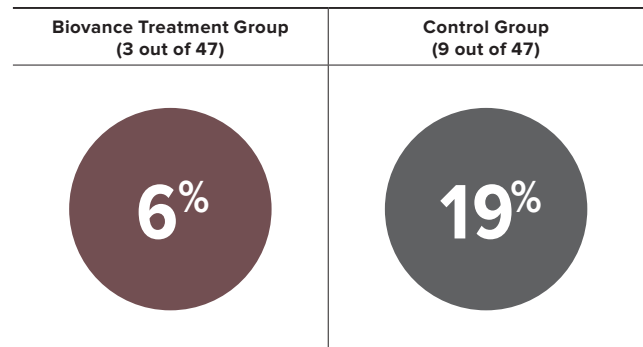

The Biovance treatment group began physical therapy **10 days earlier** than the control group.

Achieving early range of motion is important to a successful outcome and reduction of stiffness following total ankle replacement.

## CentaFlex™ Decellularized Human Placental Matrix



CentaFlex decellularized human placental matrix is derived from human umbilical cord and provides strong, durable support for soft-tissue repairs. CentaFlex placental matrix can be used as a surgical covering, wrap, or barrier to protect and support the repair of damaged tissue.

### Features and Benefits:

- Robust and strong to hold a suture
- Flexible to use across a wide variety of applications
- Biologic membrane supports the body's healing process
- Terminally sterile with 10-year shelf life
- Ambient room temperature storage
- Non-side-specific, can be placed regardless of orientation

Product Description	Item Number
CentaFlex Placental Matrix, 3 cm × 8 cm	HPM0038
CentaFlex Placental Matrix, 3 cm × 6 cm	HPM0036
CentaFlex Placental Matrix 3 cm × 4 cm	HPM0034
CentaFlex Placental Matrix, 2 cm × 3 cm	HPM0023
CentaFlex Placental Matrix, 3 cm × 3 cm	HPM0033
CentaFlex Placental Matrix, 2 cm × 2 cm	HPM0022
CentaFlex Placental Matrix, 0.5 cm × 4 cm	HPM0054

## Interfyl® Human Connective Tissue Matrix



Interfyl human connective tissue matrix is derived from the chorionic plate of the human placenta, helping to replace and supplement damaged tissue. Interfyl tissue matrix is available in flowable and particulate forms to meet a variety of surgical application needs. Minimally processed Interfyl tissue matrix helps retain the fundamental structure and functional characteristics of native connective tissue.

Product Description	Item Number
Interfyl Tissue Matrix, 50 mg particulate <b>(a)</b>	<b>HCTM050</b>
Interfyl Tissue Matrix, 100 mg particulate	<b>HCTM100</b>
Interfyl Tissue Matrix, 0.3 mL flowable	<b>HCTM030</b>
Interfyl Tissue Matrix, 0.6 mL flowable	<b>HCTM060</b>
Interfyl Tissue Matrix, 1 mL flowable	<b>HCTM010</b>
Interfyl Tissue Matrix, 1.5 mL flowable <b>(b)</b>	<b>HCTM015</b>

### Features and Benefits:

- Highly adaptable and suited for a variety of surgical applications where there is a need to replace or supplement damaged or inadequate integumental tissue
- Can fill irregular spaces and conform to challenging contours
- Completely decellularized
- Ready to use with room temperature storage
- 10-year shelf life



# Interfyl®

Human Connective Tissue Matrix  
A Celularity Innovation



## Tendon Allografts—Standard Grafts

Use of allograft tendons for primary and revision ACL and PCL reconstructions reduces OR time and eliminates the risk of donor site morbidity.<sup>43</sup>

Product Description	JRF Ortho Part No.	LifeNet Health Part No.
Achilles Tendon w/ Bone Block	<b>ACT-001</b>	<b>FATB</b>
Achilles Tendon w/o Bone Block	<b>AWO-001</b>	<b>FAT</b>
Anterior Tibialis Tendon, short length, D = 8 mm-11 mm, L = 170 mm-200 mm		<b>FANT-SL</b>
Posterior Tibialis Tendon, short length, D = 8 mm-11 mm, L = 170 mm-200 mm		<b>FPOST-SL</b>
Peroneus Longus Tendon, short length, D = 8 mm-11 mm, L = 170 mm-200 mm		<b>FPLT-SL</b>
All-Inside Double D = 1 ea 6 mm + 1 ea 5 mm-7 mm, L = 170 mm-200 mm		<b>FDBLTEND</b>
Tibialis Tendon, anterior	<b>DAT-001</b>	<b>FANT/TIB/T</b>
Tibialis Tendon, posterior	<b>41617000/1021-14</b>	<b>FPOST.TIBIAL</b>
Tibialis Tendon, double bundle		<b>FDBLTEND</b>
Gracilis, double strand	<b>DSG-001</b>	
Patellar Tendon, bisected/hemi	<b>HPL-001</b>	<b>FBPL</b>
Patellar Tendon, bisected, small block		<b>FBPLSB</b>
Patellar Tendon, whole	<b>WPL-001</b>	<b>FWPL</b>
Patellar Tendon, whole, small block		<b>FWPLSB</b>
Patellar Tendon, whole, w/ quadriceps		<b>FWPLQ</b>
Patellar Tendon, whole, w/ extensor mechanism		<b>FWPLQEXT</b>
Peroneus Longus, double strand	<b>DSP-001</b>	
Peroneus Tendon		<b>FPLT</b>
Preshaped Achilles Tendon, 9 mm	<b>ATP-091</b>	
Preshaped Achilles, 10 mm	<b>ATP-101</b>	<b>FATB10</b>
Preshaped Achilles, 11 mm	<b>ATP-111</b>	<b>FATB11</b>
Preshaped Patellar Tendon, 10 mm	<b>PLP-101</b>	<b>FPL10</b>
Preshaped Patellar Tendon, 11 mm	<b>PLP-111</b>	<b>FPL11</b>
Preshaped Quadriceps Tendon, 10 mm	<b>QDT-101</b>	
Quadruple Strand Peroneous Longus	<b>44217004</b>	
Quadriceps Tendon w/ Bone	<b>QDT-001</b>	
Semitendinosus, double strand	<b>DST-001</b>	
Semitendinosus and Gracilis Tendons	<b>QSG-001</b>	<b>1FST+/1FGRACILIS</b>
Semitendinosus Tendon, min L = 230 mm, min D > 4 mm		<b>FST</b>
Semitendinosus Tendon, L = 160 mm-180 mm, D = 4 mm-6 mm		<b>FSTP</b>
Anterior Tibialis Tendon, small joint	<b>SAT-001</b>	<b>FANT-SL</b>
Gracilis Tendon, small joint	<b>SSG-001</b>	<b>FGRACILIS</b>
Peroneus Longus, small joint		<b>FPLT-SL</b>
Posterior Tibialis Tendon, small joint		<b>FPOST-SL</b>
Fascia Lata, small, 30 mm × 60 mm		<b>FL S</b>
Fascia Lata, medium, 30 mm × 150 mm		<b>FL M</b>
Fascia Lata, large, 80 mm × 200 mm		<b>FL L</b>
GraftRope		<b>FROPE</b>



## Aseptic Tendons



Arthrex offers a full complement of aseptically processed tendons and preshaped tendons.

Aseptically processed tendons undergo advanced cleaning technologies while preserving the biomechanical integrity of the tissue.

- Uses proprietary bioburden reduction steps that remove blood and lipids
- Solutions do not include hydrogen peroxide, peracetic acid, or other harsh chemicals
- Microbiology membrane filtration process for aseptic allografts
  - The liquid culture testing method is superior to swab cultures in microbial detection<sup>44</sup>
  - Fluid extraction testing is more accurate because contamination is difficult to detect by swabbing the external surface of the graft<sup>45</sup>
  - Final product is tested using microbiological verification testing per USP <71> sterility tests
  - Strict donor screening
- Compliance with guidelines and regulations from the American Association of Tissue Banks (AATB), Food and Drug Administration (FDA), and many other state health departments
- No pre- or post-irradiation of the tendons

### Aseptic Tendons

Product Description	JRF Ortho Part No.
Achilles Tendon w/ Bone Block	ACT-002
Achilles Tendon w/o Bone Block	AWO-002
Achilles Tendon, preshaped, 9 mm <b>(a)</b>	ATP-092
Achilles Tendon, preshaped, 10 mm	ATP-102
Achilles Tendon, preshaped, 11 mm	ATP-112
Hemi-Patellar Ligament	HPL-002
Whole-Patellar Ligament	WPL-002
Whole-Patellar Ligament w/ Quadriceps	WPQ-002
Quadriceps Tendon w/ Bone	QDT-001
Quadriceps Tendon w/ Bone, preshaped, 10 mm	QDT-102
Patellar Ligament, preshaped, 10 mm <b>(b)</b>	PLP-102
Patellar Ligament, preshaped, 11 mm	PLP-112
Double Strand Semitendinosus Tendon	DST-002
Double Strand Peroneous Longus	DSP-002
Double Strand Anterior Tibialis	DAT-002
Double Strand Posterior Tibialis	DAP-002
Quadruple Strand Semitendinosus/Gracilis	QSG-002
Single Strand Semitendinosus Tendon	SST-002
Single Strand Anterior Tibialis <b>(c)</b>	SAT-002



# Wound Care

JumpStart® Antibacterial Wound Dressing.....	74
Energel® Wound Hydrogel.....	75
JumpStart FlexEFit™ Antibacterial Wound Dressing.....	76
JumpStart Pin Site Dressing Kit.....	77

## JumpStart® Antibacterial Wound Dressing

### JumpStart Dressing Powered by V.Dox™ Technology

JumpStart dressings are provided on an ultra-thin, lightweight, polyester substrate and contain laser-cut fenestrations to allow easy passage of wound exudate into the absorbent layer or a secondary dressing. The flexible design easily contours to the body. JumpStart dressings may be applied directly over sutures, staples, Steri-Strip™ wound closures, and liquid skin adhesives. The dot matrix pattern of embedded microcell batteries generate microcurrents on the dressing surface in the presence of a conductive medium, such as sterile saline, water-based gel, or wound exudate.

#### JumpStart Contact Layer Dressing

Dressing Size (in)	Qty/Box	Item Number
1 × 1 Fenestrated	10	ABS-4001
1.5 × 8	10	ABS-4005
1.5 × 10	10	ABS-4006
2 × 2	10	ABS-4002
2 × 5	10	ABS-4025
3 × 3	10	ABS-4003
4 × 4	10	ABS-4004
8 × 8	1	ABS-4008
12 × 12	1	ABS-4012

#### JumpStart Composite Dressing

Adhesive Size (in)	Dressing Size (in)	Qty/Box	Item Number
2.5 diameter	1 diameter	10	ABS-4054
4 diameter	1 diameter	10	ABS-4056
4 × 4	2 × 2	5	ABS-4053
5 × 6	1.5 × 5	5	ABS-4051
4.5 × 10	1.5 × 7	5	ABS-4052
6 × 11.5	2 × 9	5	ABS-4050
4.4 × 9.6	1.5 × 6.5	5	ABS-4057
4.2 × 7.5	1.4 × 4.5	5	ABS-4058

V.Dox is a trademark of Vomarix Innovations, Inc.

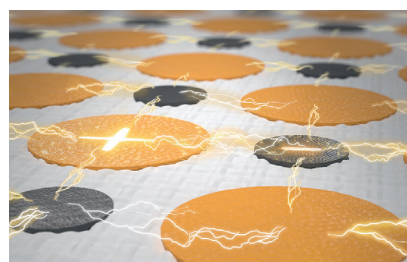
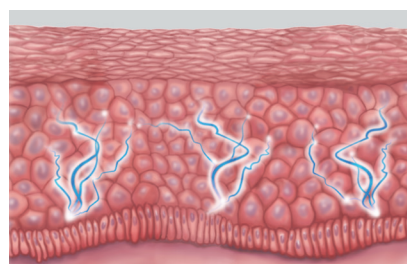
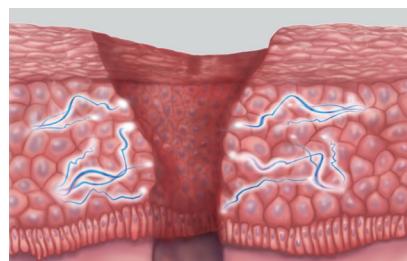
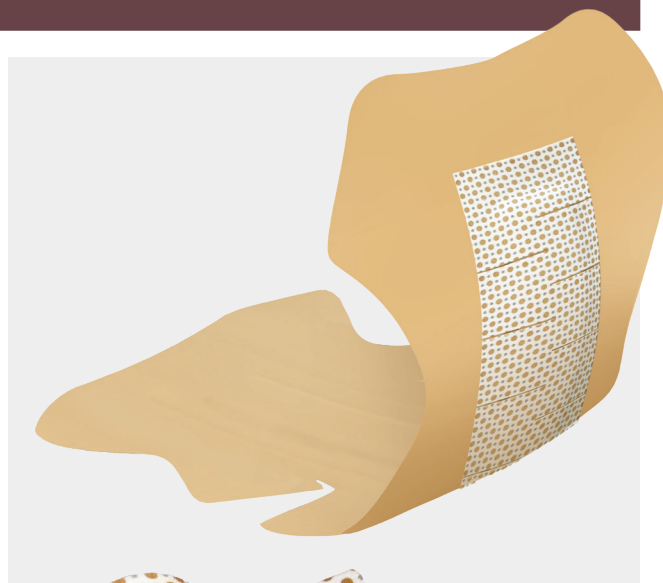

When skin is wounded, a change in electric potential occurs. The physiologic microcurrents contribute to healing.<sup>46</sup> JumpStart dressing employs embedded microcell batteries that generate an electric field designed to mimic the body's own physiologic electric fields.



## Energel® Wound Hydrogel

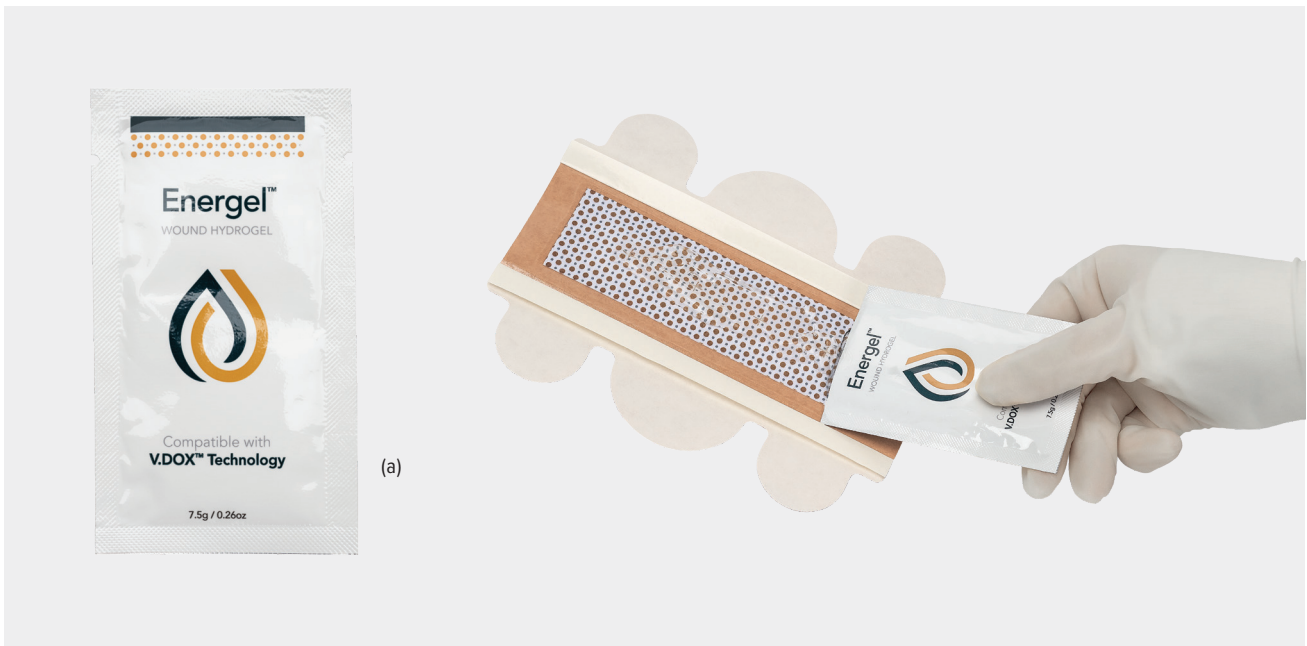

### Energel\* Wound Hydrogel Features

Use Energel wound hydrogel to activate JumpStart® dressing's microcell batteries:

- Sterile, water-soluble gel formulated to maintain a moist wound environment and provide moisture to a dry wound
- Double-packaged sterile for use in the operating room
- Optimally sized for single use (7.5 g)
- Maintains conductivity of JumpStart dressing for up to 7 days

Product Description	Item Number
Energel Wound Hydrogel (a)	AGL-L075-10



## JumpStart® FlexEFit™ Antibacterial Wound Dressing

### Three-Layer Dressing

JumpStart antibacterial wound contact layer  
powered by V.Dox™ technology

Highly absorbent middle layer

Antimicrobial barrier adhesive layer

Gentle and durable transparent film adhesive layer

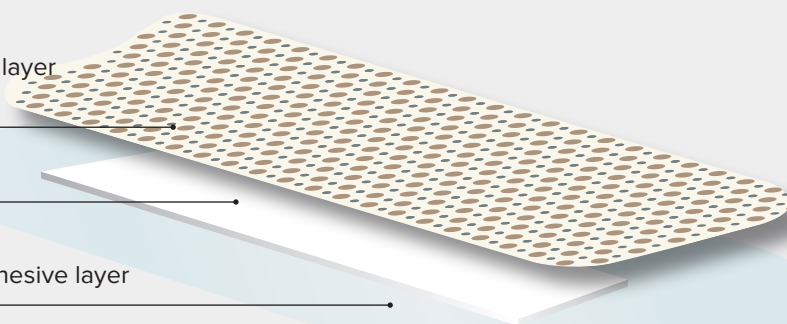

JumpStart FlexEFit antibacterial wound dressing features a patented design that enables it to link and build to universally fit virtually any incision length and curvature with just one product.

JumpStart FlexEFit dressing is exclusively powered by V.Dox technology, the only nonantibiotic, antibacterial technology that is inspired by the skin's natural electrical healing process with demonstrated antibacterial impact against a broad spectrum of bacteria, including multidrug-resistant and biofilm-forming bacteria.<sup>47-49</sup>

Reduce the risk of infection and promote wound healing with a single product that can meet virtually all postsurgical dressing needs.

### Reduce Risk of Infection

- Kills a broad spectrum of pathogens, including multidrug-resistant and biofilm-forming bacteria<sup>47-49</sup>
- In preclinical studies, disrupts existing biofilm infection and prevents biofilm from forming<sup>50</sup>
- Prevents bacterial growth, with sustained antibacterial impact for up to 7 days<sup>51</sup>
- Demonstrates improved antibacterial impact versus silver dressings<sup>50</sup>

### Promote Healing

- Improves re-epithelialization with JumpStart dressings versus standard dressings<sup>52</sup>

JumpStart FlexEFit Wound Dressings

Pad Dimensions	Adhesive Dimensions	Qty/Box	Item Number
1.5 × 4.5 (in)	2.5 × 6.3 (in)	5	ABS-4060-05
3.8 × 11.4 (cm)	6.3 × 16 (cm)	10	ABS-4060-10

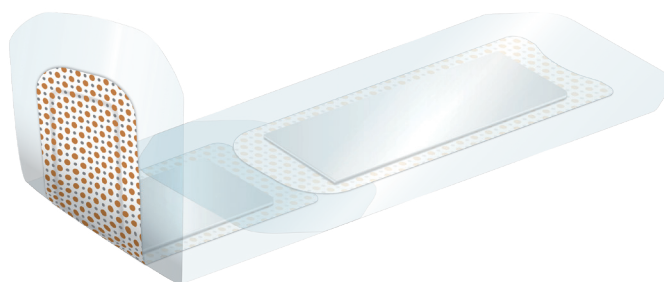

## JumpStart® Pin Site Dressing Kit



The JumpStart pin site dressing kit includes three products: one JumpStart dressing pad, one absorbent gauze, and one holding clip. The 2-in diameter JumpStart dressing is easily placed over external fixation device pins to protect against a broad spectrum of bacteria while also promoting a more natural healing process. The absorbent disk and holding clip help maintain a moist wound environment, the optimal environment for healing when using JumpStart dressing.

### Features and Benefits:

- Perfectly sized to fit around external fixation devices
- V.Dox™ technology is effective against multidrug-resistant bacteria and disrupts biofilm matrix
- Promotes healing
- Easy and simple to use
- Single use
- Can be left on for up to 7 days<sup>a</sup>

Product Description	Item Number
JumpStart Pin Site Dressing Kit	ABS-4059

<sup>a</sup>Absorbent pad can be changed if exudate levels are high

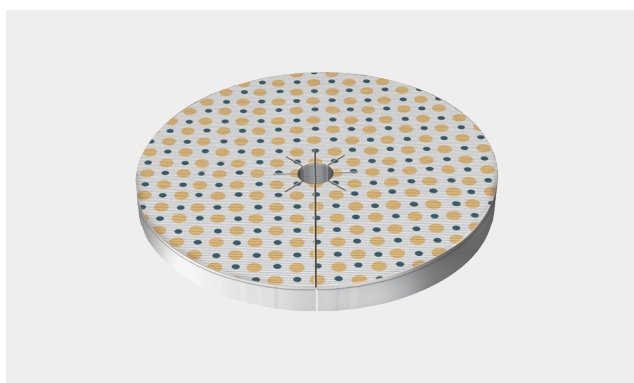



# References

1. Scott A, Khan KM, Roberts CR, Cook JL, Duronio V. What do we mean by the term “inflammation”? A contemporary basic science update for sports medicine. *Br J Sports Med.* 2004;38(3):372-380. doi:10.1136/bjism.2004.011312
2. Jiang N, Tan NS, Ho B, Ding JL. Respiratory protein-generated reactive oxygen species as an antimicrobial strategy. *Nat Immunol.* 2007;8(10):1114-1122. doi:10.1038/ni1501
3. Arthrex, Inc. Data on file (APT-5368). Naples, FL; 2021.
4. Arthrex, Inc. Data on file (APT-5535). Naples, FL; 2022.
5. Arthrex, Inc. Data on file (APT-5756). Naples, FL; 2022.
6. Knutsen G, Engebretsen L, Ludvigsen TC, et al. Autologous chondrocyte implantation compared with microfracture in the knee. *J Bone Joint Surg Am.* 2004;86-A(3):455-464.
7. Kramer J, Böhrnsen F, Lindner U, et al. In vivo matrix-guided human mesenchymal stem cells. *Cell Mol Life Sci.* 2006;63(5):616-626. doi:10.1007/s00018-005-5527-z
8. Herrigou PH, Poignard A, Beaujean F, Rouard H. Percutaneous autologous bone marrow grafting for nonunions: influence of the number and concentration of progenitor cells. *J Bone Joint Surg Am.* 2005;87(7):1430-1437. doi:10.2106/JBJS.D.02215
9. Connolly JF, Guse R, Tiedeman J, Dehne R. Autologous marrow injection as a substitute for operative grafting of tibial nonunions. *Clin Orthop Relat Res.* 1991;(266):259-270.
10. Lim JK, Hui J, Li L, Thambyah A, Goh J, Lee EH. Enhancement of tendon graft osteointegration using mesenchymal stem cells in a rabbit model of anterior cruciate ligament reconstruction. *Arthroscopy.* 2004;20(9):899-910. doi:10.1016/j.arthro.2004.06.035
11. Ouyang HW, Goh JC, Lee EH. Use of bone marrow stromal cells for tendon graft-to-bone healing: histological and immunohistochemical studies in a rabbit model. *Am J Sports Med.* 2004;32(2):321-327. doi:10.1177/0095399703258682
12. Choi LS, Ma R, Zeng Q, et al. Bone marrow aspirate with or without platelet concentrates as a bone graft substitute for posterolateral spinal fusion: a randomized, controlled study using an animal model. Paper presented at: 52nd Annual Meeting of the Orthopaedic Research Society; March 18-22, 2006.
13. Pountos I, Jones E, Tzioupis C, McGonagle D, Giannoudis PV. Growing bone and cartilage: the role of mesenchymal stem cells. *J Bone Joint Surg (Br).* 2006;88-B:421-426. doi:10.1302/0301-620X.88B4
14. Martin GJ, Boden SD, Titus L, Scarborough NL. New formulations of demineralized bone matrix as a more effective graft alternative in experimental posterolateral lumbar spine arthrodesis. *Spine.* 1999;24(7):637-645. doi:10.1097/00007632-199904010-00005
15. US Food and Drug Administration. Summary of safety and effectiveness (SSED) for SynJoynT. Accessed February 6, 2023. [https://www.accessdata.fda.gov/cdrh\\_docs/pdf17/P170016B.pdf](https://www.accessdata.fda.gov/cdrh_docs/pdf17/P170016B.pdf)
16. CellRight Technologies, LLC. Data on file (ConCelltrate® 100 histology and in-vitro alkaline phosphate induction assay). Universal City, TX; 2017.
17. Demyttenaere J, Claes S, Bellemans J. One-stage revision anterior cruciate ligament reconstruction in cases with excessive tunnel osteolysis. Results of a new technique using impaction bone grafting. *Knee.* 2018;25(6):1308-1317. doi:10.1016/j.knee.2018.08.015
18. MARS Group, Ding DY, Zhang AL, et al. Subsequent surgery after revision anterior cruciate ligament reconstruction: rates and risk factors from a multicenter cohort. *Am J Sports Med.* 2017;45(9):2068-2076. doi:10.1177/0363546517707207
19. Richter DL, Werner BC, Miller MD. Surgical pearls in revision anterior cruciate ligament surgery. When must I stage? *Clin Sports Med.* 2017;36:173-187. doi:10.1177/0363546517707207
20. Werner BC, Gilmore CJ, Hamann JC, et al. Revision ACL reconstruction: results of a single-stage approach using allograft dowel bone grafting for femoral defects. *J Am Acad Orthop Surg.* 2016;24(8):581-587. doi:10.5435/JAAOS-D-15-00572
21. Hench LL, Polak JM, Xynos ID, Buttery LDK. Bioactive materials to control cell cycle. *Mater Res Innov.* 2000;3(6):313-323. doi:10.1007/s100190000055
22. Matsuura A, Kubo T, Doi K, et al. Bone formation ability of carbonate apatite-collagen scaffolds with different carbonate contents. *Dent Mater J.* 2009;28(2):234-242. doi:10.4012/dmj.28.234
23. Ellies LG, Carter JM, Natiella JR, Featherstone JD, Nelson DG. Quantitative analysis of early in vivo tissue response to synthetic apatite implants. *J Biomed Mater Res.* 1988;22(2):137-148. doi:10.1002/jbm.820220206
24. Mataragas, N. Integra LifeSciences. Data on file (Radiographic analysis of fusion success with Integra Collagen Ceramic Matrix, as compared to autograft use, in posterolateral lumbar spine arthrodesis). Princeton, NJ; 2010.
25. Geiger M, Li RH, Friess W. Collagen sponges for bone regeneration with rhBMP-2. *Adv Drug Deliv Rev.* 2003;55:1613-1629.
26. Tanaka T, Kumagai Y, Saito M, et al. Bone formation and resorption in patients after implantation of beta-tricalcium phosphate blocks with 60% and 75% porosity in opening-wedge high tibial osteotomy. *J Biomed Mater Res B Appl Biomater.* 2008;86(2):453-459. doi:10.1002/jbm.b.31041
27. Dong J, Uemura T, Shirasaki Y, Tateishi T. Promotion of bone formation using highly pure porous beta-TCP combined with bone marrow-derived osteoprogenitor cells. *Biomaterials.* 2002;23(23):4493-4502.
28. Arthrex, Inc. Data on file (APT-03989). Naples, FL; 2019.
29. Cheng NC, Estes BT, Awad HA, Guilak F. Chondrogenic differentiation of adipose-derived adult stem cells by a porous scaffold derived from native articular cartilage extracellular matrix. *Tissue Eng Part A.* 2009;15(2):231-241. doi:10.1089/ten.tea.2008.0253
30. Chadha N, Dang A, Sampson E, et al. Porous cartilage-derived matrix scaffolds for repair of articular cartilage defects. Poster presented at: Orthopaedic Research Society Annual Meeting; February 4-7, 2012; San Francisco, CA.
31. Malinin T, Temple HT, Carpenter EM. Induction of regeneration of articular cartilage defects by freeze-dried particulate cartilage allografts. Poster presented at: International Cartilage & Joint Preservation Society Annual Meeting; 2009; Miami, FL.
32. Arthrex, Inc. and Osiris Therapeutics, Inc. LA1-00007-EN\_A. Naples, FL; 2015.
33. Chen MI, Branch TP, Hutton WC. Is it important to secure the horns during lateral meniscal transplantation? A cadaveric study. *Arthroscopy.* 1996;12(2):174-181.
34. Seiter MN, Haber DB, Ruzbarsky JJ, Arner JW, Peebles AM, Provencher MT. Segmental meniscus allograft transplantation. *Arthrosc Tech.* 2021;10(3):e697-e703. doi:10.1016/j.eats.2020.10.059
35. Kasik C, Martinkovich S, Mosier B, et al. Short-term outcomes for the biologic treatment of bone marrow edema of the knee using bone marrow aspirate concentrate and injectable demineralized bone matrix. *ASMAR.* 2019;1(1):e7-e14. doi.org/10.1016/j.asmr.2019.07.001
36. Herrigou P, Poignard A, Beaujean F, Rouard H. Percutaneous autologous bone-marrow grafting for nonunions. Influence of the number and concentration of progenitor cells. *J Bone Joint Surg Am.* 2005;87(7):1430-1437. doi:10.2106/JBJS.D.02215
37. Sánchez M, Delgado D, Sánchez P, et al. Combination of intra-articular and intraosseous injections of platelet rich plasma for severe knee osteoarthritis: a pilot study. *Biomed Res Int.* 2016;4868613. doi:10.1155/2016/4868613
38. Hartzler RU, Softic D, Qin X, Dorfman A, Adams CR, Burkhart SS. The histology of a healed superior capsular reconstruction dermal allograft: a case report. *Arthroscopy.* 2019;35(10):2950-2958. doi:10.1016/j.arthro.2019.06.024
39. Mirzayan R, Bouz G. Biologic Tuberopecty with an acellular dermal allograft for massive rotator cuff tears. *Arthrosc Tech.* 2021;10(7):e1743-e1749. doi:10.1016/j.eats.2021.03.016
40. Kim SS, Sohn SK, Lee KY, Lee MJ, Roh MS, Kim CH. Use of human amniotic membrane wrap in reducing perineural adhesions in a rabbit model of ulnar nerve neurolysis. *J Hand Surg Eur.* 2010;35(3):214-219. doi:10.1177/1753193409352410
41. Bhatia M, Pereira M, Rana H, Stout B, Lewis C, Abramson S. The mechanism of cell interaction and response on decellularized human amniotic membrane: Implications in wound healing. *Wounds.* 2007;19(8):207-217.
42. Brigid SA, Riniker ML, Protzman NM. Constant DD application of acellular amniotic scaffold following total ankle replacement: a retrospective comparison. *Clin Res Foot Ankle.* 2018; 6(275). doi:10.4172/2329-910X.1000275
43. Poehling GG, Curl WW, Lee CA, et al. Analysis of outcomes of anterior cruciate ligament repair with 5-year follow-up: allograft versus autograft. *Arthroscopy.* 2005;21(7):774-785. doi:10.1016/j.arthro.2005.04.112
44. Fanelli GC, Giannotti BF, Edson CJ. Arthroscopically assisted combined anterior and posterior cruciate ligament reconstruction. *Arthroscopy.* 1996;12(1):5-1435.
45. Klimkiewicz JJ, Samsell BJ, Rif A, DeBerardino T, Moore MA. Comparison of human tendon allografts and autografts used in knee reconstruction. *Curr Orthop Pract.* 2011;22(6):494-502. doi:10.1097/BCO.0b013e318236c466
46. Zhao M. Electrical fields in wound healing—an overriding signal that directs cell migration. *Semin Cell Dev Biol.* 2009;20(6):674-682. doi:10.1016/j.semcdb.2008.12.009
47. Kim H, Makin I, Skiba J, et al. Antibacterial efficacy testing of a bioelectric wound dressing against clinical wound pathogens. *Open Microbiol J.* 2014;8:15-21. doi:10.2174/1874285801408010015
48. Banerjee J, Ghatak P, Roy S, et al. Silver-zinc redox-coupled electrochemical wound dressing disrupts bacterial biofilm. *PLoS One.* 2015;11-15. doi:10.1371/journal.pone.0119531
49. Kim H, Izadjo M. Antibiofilm efficacy evaluation of a bioelectric dressing in mono- and multi-species biofilms. *J Wound Care.* 2015;24 Suppl 2:S10-S14. doi:10.12968/jowc.2015.24.Sup2.S10
50. Barki K, Das A, Dixit S, et al. Electric field based dressing disrupts mixed species bacterial biofilm infection and restores functional wound healing. *Ann Surg.* 2019;269(4):756-766. doi:10.1097/SLA.0000000000002504.41
51. Vomar Innovations, Inc. Data on file (SLM090512CMC01F). Tempe, AZ.
52. Blount A, Foster S, Rapp D, et al. The use of bioelectric dressings in skin graft harvest sites: a prospective case series. *J Burn Care Res.* 2012;33(3):354-357. doi:10.1097/BCR.0b013e31823356e4



This description of technique is provided as an educational tool and clinical aid to assist properly licensed medical professionals in the usage of specific Arthrex products. As part of this professional usage, the medical professional must use their professional judgment in making any final determinations in product usage and technique. In doing so, the medical professional should rely on their own training and experience and should conduct a thorough review of pertinent medical literature and the product's directions for use. Postoperative management is patient-specific and dependent on the treating professional's assessment. Individual results will vary and not all patients will experience the same postoperative activity level or outcomes.

View U.S. Patent information at [www.arthrex.com/corporate/virtual-patent-marking](http://www.arthrex.com/corporate/virtual-patent-marking)

**arthrex.com**

© 2023-02 Arthrex, Inc. All rights reserved. LB1-0804-en-US\_P



# Orthopedics - NORA