

Knee

Next Generation in
Repair and Reconstruction

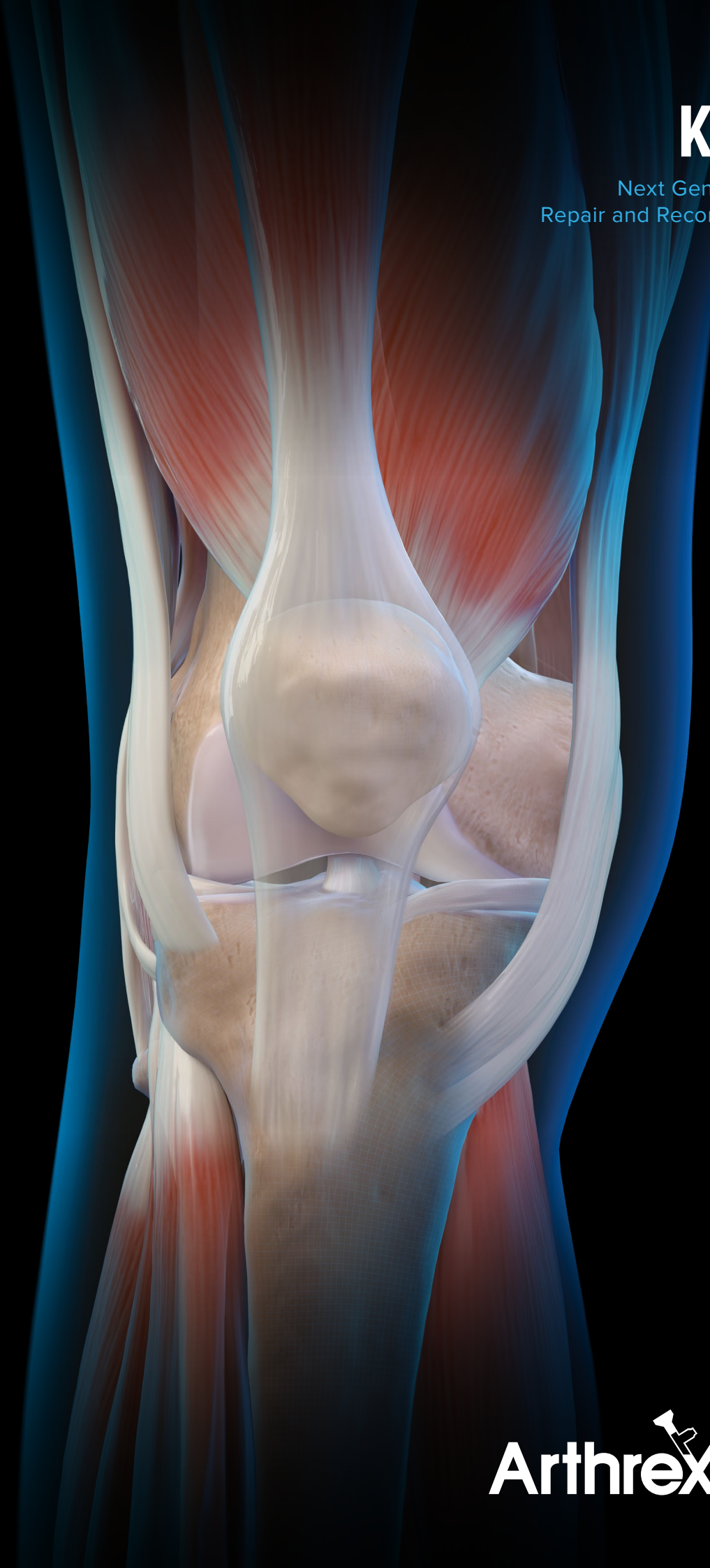

Arthrex® 

Helping Surgeons Treat Their Patients Better®

Since its inception, Arthrex has been committed to one mission: Helping Surgeons Treat Their Patients Better. We are strategically focused on constant product innovation through scientific research, surgeon collaboration, and medical education to make less invasive surgical procedures simple, safer, and more reproducible. Each year, we develop more than 1000 new innovative products and procedures to advance minimally invasive orthopedics worldwide.

Arthrex has always remained a privately held company, which allows for the rapid evaluation of new technologies and ideas and the freedom to develop products and techniques that truly make a difference. Our experienced team of dedicated professionals represents a shared passion and commitment to delivering uncompromising quality to the health care providers who use our products and the millions of patients whose lives we impact.

The medical significance of our contributions serves as our primary benchmark of success and will continue into the future as the legacy of Arthrex.

Table of Contents

ACL Repair	05
ACL Reconstruction.....	09
Tunnel and Socket Preparation and Drilling.....	13
ACL/PCL Accessories	23
Soft-Tissue Graft Harvesting.....	27
BTB Graft Harvesting.....	33
FiberWire® Suture	37
Graft Prep, Sizing, and Pretensioning.....	45
Graft Fixation.....	49
Screw Insertion and Removal.....	63
PCL Reconstruction.....	67
Collateral Ligament Reconstruction and Repair.....	73
Patellofemoral Procedures	81
Meniscal Repair	89
Meniscal Resection.....	101
Osteochondral Repair	105
Osteochondral Transplant.....	111
Opening Wedge Osteotomy.....	119
Bone Graft Harvesting.....	125

The *Internal/Brace*™ surgical technique is intended only to augment the primary repair/reconstruction by expanding the area of tissue approximation during the healing period and is not intended as a replacement for the native ligament. The *Internal/Brace* technique is for use during soft tissue-to-bone fixation procedures and is not cleared for bone-to-bone fixation.

ACL Repair

ACL Repair TightRope® System 06

SwiveLock® ACL Repair Kit..... 07

ACL Repair TightRope® System

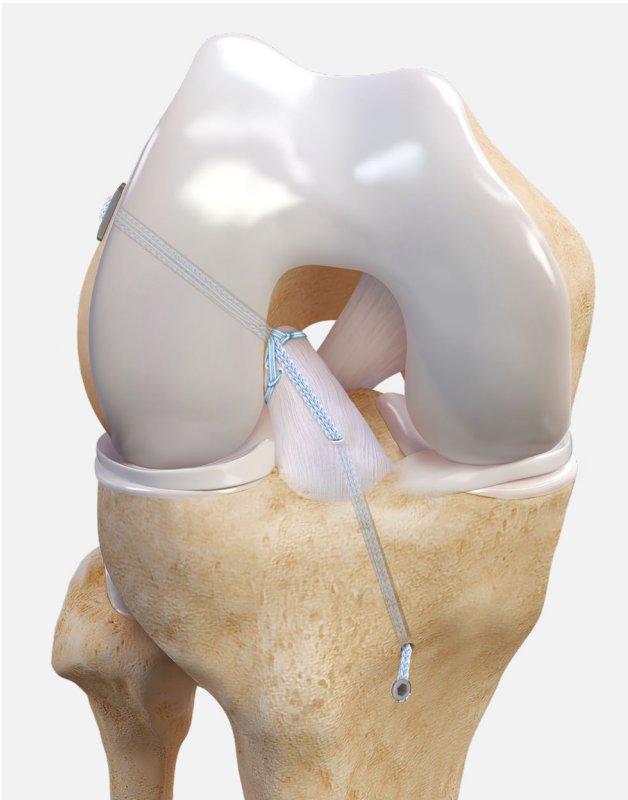

The ACL Repair TightRope system is a knotless, tensionable system designed for ACL primary repair. This implant comes preassembled with a FiberTape® suture for the *Internal/Brace*™ technique. The system uses FiberRing™ sutures to stitch the torn ligament tissue. FiberRing sutures are then connected to the ACL Repair TightRope implant, enabling precise tensioning and retensioning of the ligament after cycling the leg. Available in multiple sizes, FiberRing suture can accommodate various stitching techniques.

Product Description	Item Number
ACL Repair TightRope implant w/ FiberTape suture for <i>Internal/Brace</i> technique	AR-1588R-IB
ACL button for the <i>Internal/Brace</i> technique	AR-1588TB-IB
FiberRing suture w/ shuttle loop, 25 mm (a)	AR-7282-25
FiberRing suture w/ shuttle loop, 35 mm (b)	AR-7282-35
FiberRing suture w/ shuttle loop, 45 mm (c)	AR-7282-45
FiberRing suture w/ shuttle loop, 55 mm (d)	AR-7282-55

Additional Products

Product Description	Item Number
FlipCutter® III drill	AR-1204FF
2.4 mm cannulated drill and SutureLasso™ SD wire loop suture passer	AR-1594D-24
RetroConstruction™ drill guide system instrument	AR-1510S
ACL ToolBox instrument set	AR-1900S
#2 FiberSnare® w/ #2 FiberWire® braided polyblend suture, white/blue w/ closed loop, 26 in, one end stiffened, 12 in	AR-7209SNL
#2 FiberSnare w/ #2 FiberWire braided polyblend suture, black/white w/ closed loop, 26 in, one end stiffened, 12 in	AR-7209SNT

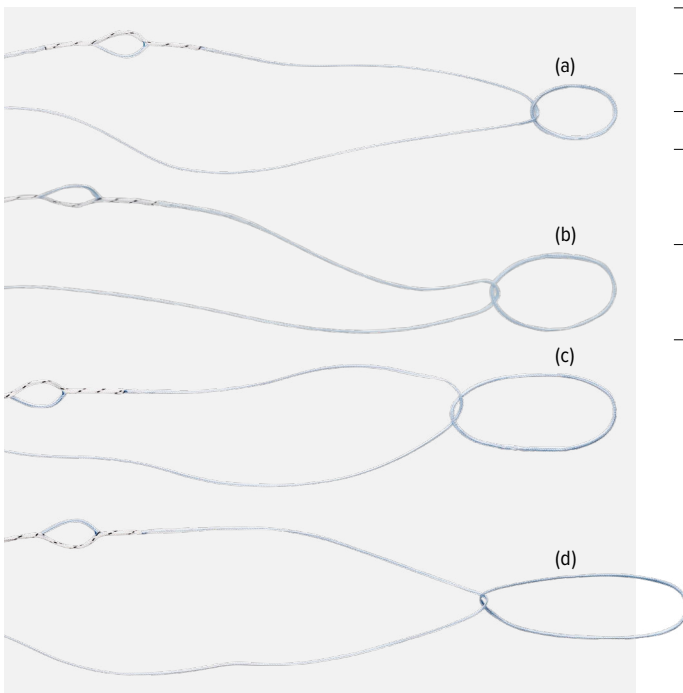

SwiveLock® ACL Repair Kit

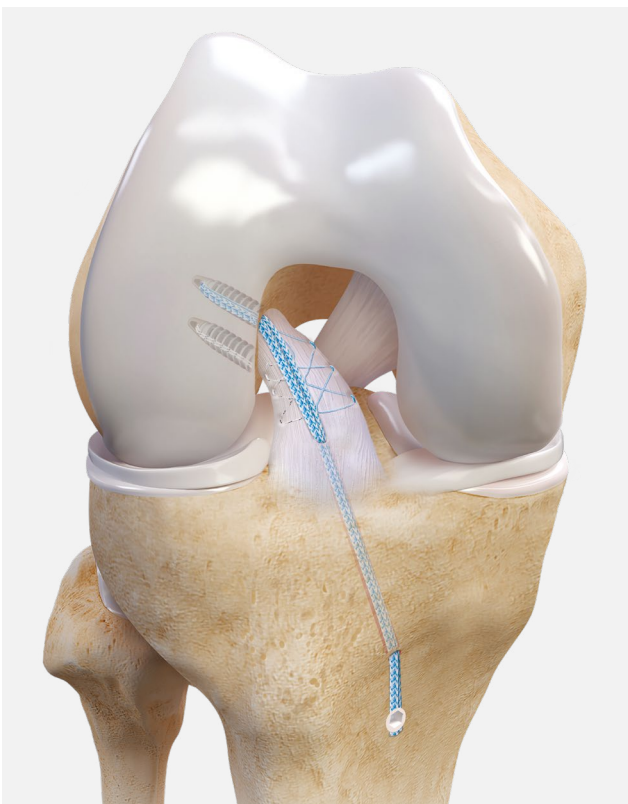
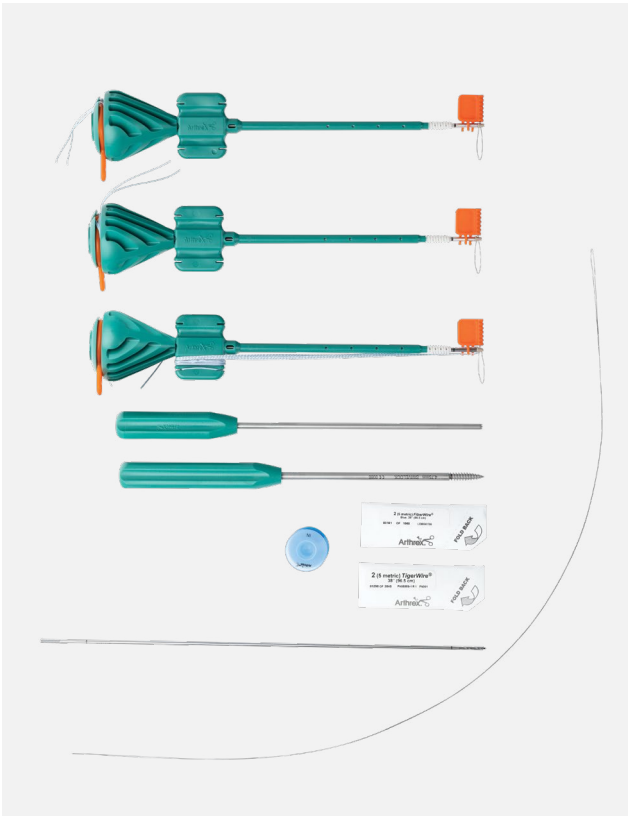

The new SwiveLock ACL repair kit allows for the preservation of native neurovascular anatomy and proprioception while eliminating graft site morbidity.¹ ACL preservation techniques have been shown to restore biomechanical strength, normal kinematics, and knee stability to improve functional outcomes.^{1,2} Adding an *Internal/Brace™* technique can protect the repair to allow natural healing and early mobilization.³

Product Description	Item Number
SwiveLock ACL Anchor Repair Kit	AR-1594
8 mm × 30 mm PassPort Button™ cannula	
2.4 mm crown-tip drill guide	
2.4 mm cannulated drill w/ SutureLasso™ suture passer	
SD loop	
#2 TigerWire® suture	
#2 FiberWire® suture	
4.75 mm SwiveLock anchor punch/tap	
(2x) BioComposite SwiveLock anchor 4.75 mm × 19.1 mm	
BioComposite SwiveLock anchor 4.75 mm × 19.1 mm w/ extended-length FiberTape® loop	
2.4 mm cannulated drill	AR-1594D-24

References

1. Gipsman AM, Trasolini N, Hatch GFR 3rd. Primary anterior cruciate ligament single-bundle repair with augmentation for a partial anterior cruciate ligament tear. *Arthrosc Tech.* 2018;7(4):e367-e372. doi:10.1016/j.eats.2017.10.006
2. Chahla J, Nelson T, Dallo I, et al. Anterior cruciate ligament repair versus reconstruction: a kinematic analysis. *Knee.* 2020;27(2):334-340. doi:10.1016/j.knee.2019.10.020
3. Heusdens CHW, Hopper GP, Dossche L, Mackay GM. Anterior cruciate ligament repair using independent suture tape reinforcement. *Arthrosc Tech.* 2018;7(7):e747-e753. doi:10.1016/j.eats.2018.03.007

ACL Reconstruction

ACL ToolBox Instrumentation Set.....	10
--------------------------------------	----

ACL ToolBox Instrumentation Set

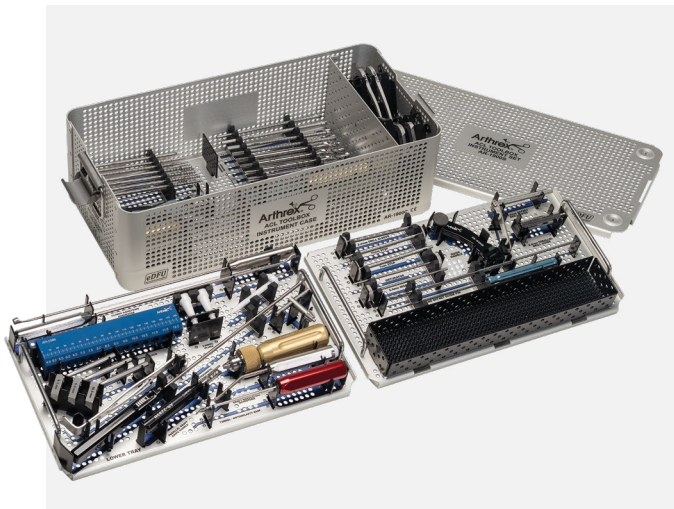

The ACL ToolBox fits the needs of most modern ACL reconstructions. The streamlined, 3-layer case contains all the reusable instruments necessary for completing most common ACLR procedures and includes an open "pin mat" area for instruments. The toolbox contains the RetroConstruction™ drill guide set with commonly used ACL marking hooks. Multiple drill sleeves are included for all techniques and can be used with standard 2.4 mm pins, 3 mm RetroDrill® pins, and 3.5 mm FlipCutter® reamers.

ACL ToolBox Set (AR-1900S)

Product Description	Item Number
Hook probe 3.4 mm tip w/ 5 mm markings	AR-10010
Side-release RetroConstruction handle	AR-1510HR
Drill sleeve for Side-Release handle, 2.4 mm, ratcheting	AR-1510FD-24
Stepped drill sleeve, 10 mm step	AR-1204FDS-10
Stepped drill sleeve, 7 mm step	AR-1510FS-7
Drill tip guide pin, 3.5 mm	AR-1250F
Cannulated drill, 8 mm	AR-1208L
Cannulated drill, 9 mm	AR-1209L
Cannulated drill, 10 mm	AR-1214L
Cannulated drill, 11 mm	AR-1217L
Parallel guide sleeve, 2.4 mm pins	AR-1245L
Offset drill guide, 3.5 mm	AR-1246-1
Offset drill guide pin, 3.5 mm	AR-1246-3
Tunnel plug for 8-12 mm drill holes	AR-1258
Semitendinosus stripper, 7 mm	AR-1278L
Tunnel/notchplasty rasp	AR-1282
Cannulated headed reamers, 8-11 mm	AR-1408 – AR-1411
Reamer handle and pin puller	AR-1415
Graft harvesting retractor	AR-1420
Femoral ACL marking hook, curved	AR-1510F-01
Footprint femoral ACL guide, left	AR-1510FL
Footprint femoral ACL guide, right	AR-1510FR
Tibial ACL marking hook for RetroConstruction drill guide	AR-1510T
RetroScrew® driver, thin	AR-1586R
Guide pin sleeve, 2.4 mm	AR-1204F-24I
Obturator, 3.5 mm	AR-1204F-OB
Transportal ACL guide, 6 mm offset	AR-1800-06
Transportal ACL guide, 7 mm offset	AR-1800-07
Transtibial femoral ACL drill guide, 7 mm	AR-1801
Transtibial femoral ACL drill guide, 6 mm	AR-1804
Reusable obturator for tibial tunnel cannula	AR-1807
Graft harvesting cutting guides, 8.5 mm, 9.5 mm, and 10.5 mm	AR-1809, 10, and 11
Notchplasty and graft harvesting osteotome, 5 mm	AR-1830
Tunnel notcher	AR-1844
Graft sizing block, 4.5-12 mm holes (0.5 mm increments)	AR-1886

ACL ToolBox (Cont)

Product Description	Item Number
Quick-connect biocomposite interference screwdriver	AR-1996CD-1
Quick-connect driver shaft, 6 mm	AR-4019D-1
Cannulated screwdriver shaft, 3.5 mm hex, Ø5.5 mm × 17 cm	AR-1998
FastThread™ screw tap, 7 mm quick connect	AR-4020T-07
FastThread screw tap, 8 mm quick connect	AR-4020T-08
FastThread screw tap, 9 mm quick connect	AR-4020T-09
FastThread screw tap, 10 mm quick connect	AR-4020T-10
SlapDriver, ratcheting quick connect	AR-1999SD
Parallel graft knife handle	AR-2285H
Chuck key	AR-8241
Atraumatic hamstring harvester	AR-10300
ACL ToolBox instrumentation case	AR-1900C

Optional

Product Description	Item Number
RetroConstruction™ marking hook for tibial ACLR, 52.5° (for RetroDrill® pin)	AR-1510R
Tibial ACL drill guide, pin tip	AR-1510GT
Universal instrument case	AR-1817C
Medial portal hook	AR-1510F-02

Tunnel and Socket Preparation and Drilling

FlipCutter® III Drill.....	14
RetroConstruction™ Drill Guide Set.....	15
Flexible Reamers for ACL Reconstruction	16
Transportal ACL Guides.....	17
Transtibial Femoral Guides.....	17
Low-Profile Reamers.....	18
Cannulated Headed Reamers	18
Coring Reamers	19
Cannulated and Sterile Cannulated Drill	20
Tunnel Dilators.....	21
Notchplasty	21

FlipCutter® III Drill



The innovative FlipCutter III drill is an adjustable, variable-size, all-in-one guide pin and reamer that allows minimally invasive inside-out socket creation. Proprietary technology allows the FlipCutter III drill unconstrained freedom of socket positioning and is ideal for difficult-to-reach applications, such as tibial socket creation for PCL reconstruction, anatomic femoral socket creation for ACL reconstruction, and socket creation for meniscal allograft transplantation or meniscal root repair. This single device drills sizes 6 mm and 7 mm to 12 mm, including half sizes.

FlipCutter III Drill (single use, sterile)

Product Description	Item Number
FlipCutter III Drill, 6-12 mm (including half sizes, except 6.5 mm)	AR-1204FF

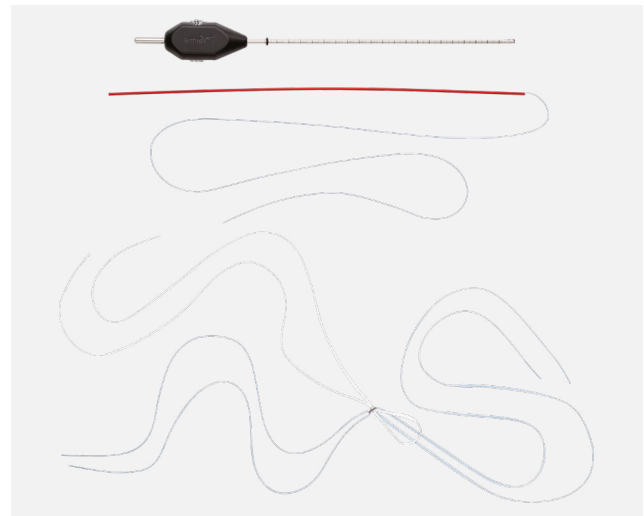

Product Description	Item Number
TightRope II RT implant, FiberTape® suture for <i>Internal/Brace™</i> technique w/ FlipCutter III drill (kit)	AR-1288RTIB-FC3

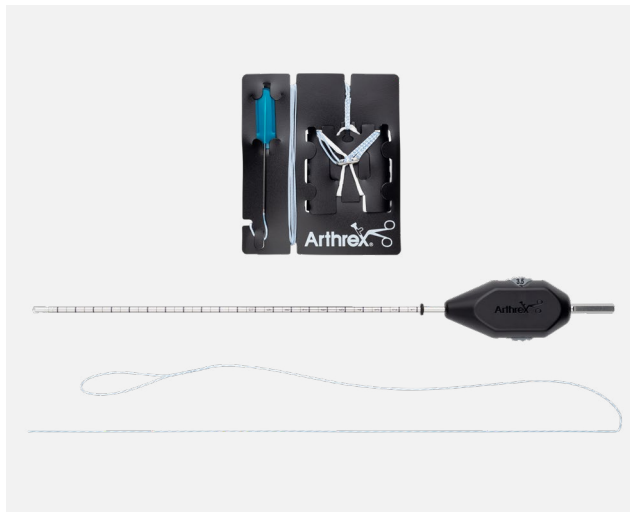

Product Description	Item Number
FiberTag® TightRope® implant, FiberTape suture for the <i>Internal/Brace</i> technique w/ FlipCutter III drill and FiberSnare® #2 FiberWire® sutures	AR-1288RTT2-FC3

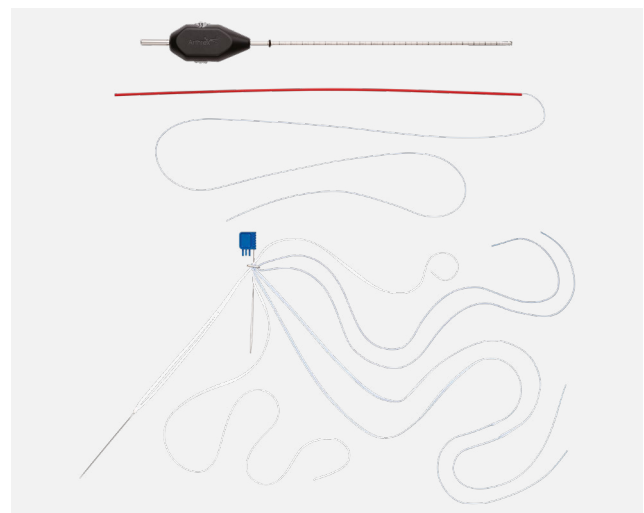

Product Description	Item Number
TightRope II BTB implant, FiberTape suture for <i>Internal/Brace</i> technique w/ FlipCutter III drill (kit)	AR-1288BTBIB-FC3

RetroConstruction™ Drill Guide Set

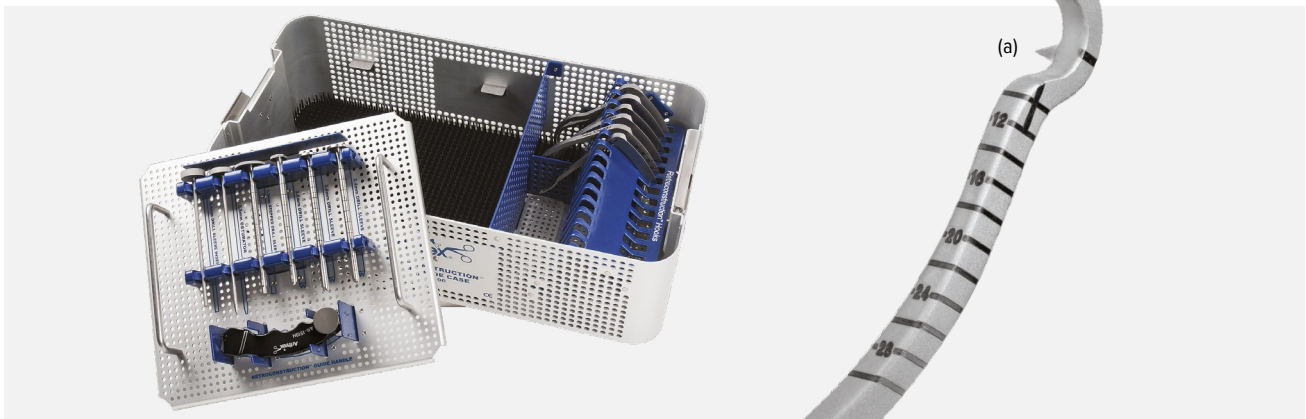

The small, easy-to-use RetroConstruction drill guide set accommodates up to 14 marking hook options for multiple applications. The adjustable C-ring allows several drilling angles without sacrificing accuracy. Multiple drill sleeves accommodate retrograde reaming with the FlipCutter® reamer and antegrade reaming with standard 2.4 mm pins. The additional stepped drill sleeve acts as a depth stop for retrograde drilling and maintains joint access during reamer removal for insertion of graft-passing sutures.

RetroConstruction Drill Guide Set (AR-1510S)

Product Description	Item Number
Side-release RetroConstruction handle	AR-1510HR
Ratchet drill sleeve, 2.4 mm	AR-1510FD-24
Stepped, ratchet drill sleeve, 10 mm step	AR-1204FDS-10
Stepped, ratchet drill sleeve, 7 mm step	AR-1510FS-7
Obturator, 3.5 mm	AR-1204F-OB
Guide pin sleeve, 2.4 mm	AR-1204F-24I
Marking hook, femoral ACL, curved	AR-1510F-01
Femoral ACL marking hook for RetroConstruction drill guide	AR-1510F
Femoral ACL marking hook, curved	AR-1510F-01

Footprint femoral ACL guide, left	AR-1510FL
Footprint femoral ACL guide, right (a)	AR-1510FR
Footprint femoral ACL guide, small angle, left	AR-1510FLS
Footprint femoral ACL guide, small angle, right	AR-1510FRS
Tibial ACL marking hook drill guide	AR-1510T
Pin tip tibial marking hook ACL guide	AR-1510GT
Pin tip tibial marking hook ACL guide, small angle	AR-1510GTS
Femoral PCL hook arm	AR-1510PF
Tibial PCL hook arm	AR-1510PT
Anatomic contour PCL guide, left	AR-1510PTL
Anatomic contour PCL guide, right	AR-1510PTR
Multiuse hook	AR-1510M
Drill tip guide pin, 3.5 mm (pre-drill pin for FlipCutter reamer)	AR-1250F
RetroConstruction marking hook for tibial ACLR, 52.5° (for RetroDrill® reamer)	AR-1510R
Footprint femoral ACL guide, w/ 7 mm offset, left	AR-1510FPL
Footprint femoral ACL guide, w/ 7 mm offset, right	AR-1510FPR

Optional

Product Description	Item Number
Medial portal hook	AR-1510F-02

Flexible Reamers for ACL Reconstruction

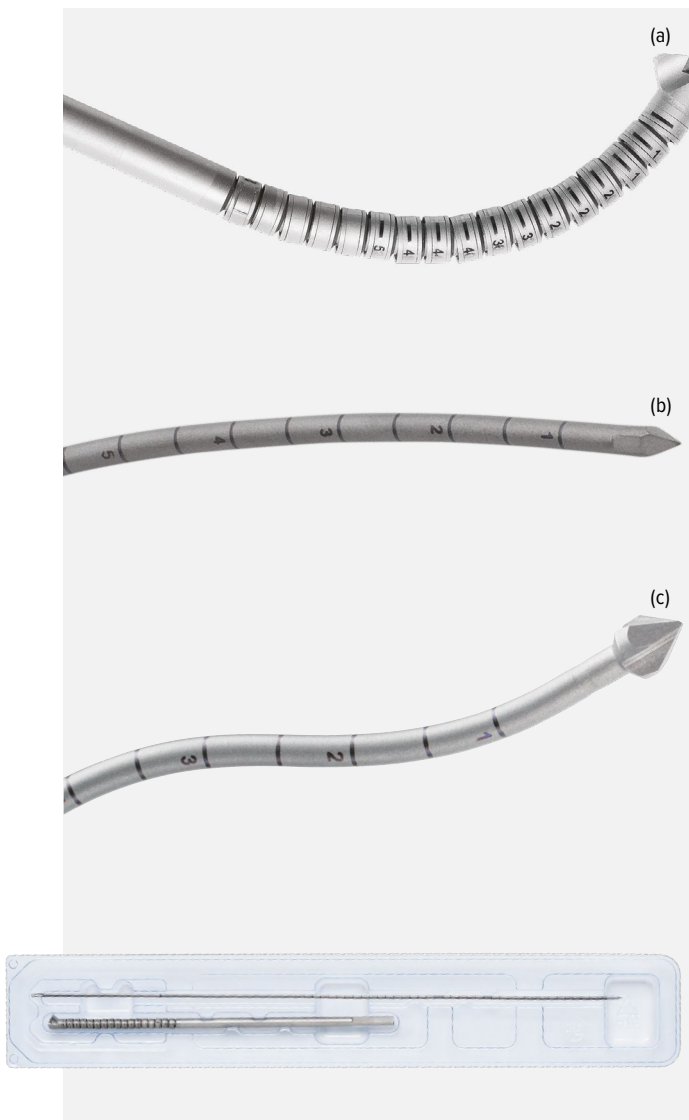

The Flexible Reamer System facilitates reproducible femoral socket creation from the medial portal without hyperflexion of the knee. An innovative, flexible-link design allows unmatched flexibility with increased strength over standard “puzzle piece” designs.¹ The adjustable curved guide, flexible guide pins, and screwdrivers give surgeons more versatility in socket placement and graft fixation options.

Flexible Reamer (a) w/ Flexible Guide Pin (b)

Product Description	Item Number
Flexible reamer w/ flexible guide pin, 7 mm	AR-1400F-70
Flexible reamer w/ flexible guide pin, 7.5 mm	AR-1400F-75
Flexible reamer w/ flexible guide pin, 8 mm	AR-1400F-80
Flexible reamer w/ flexible guide pin, 8.5 mm	AR-1400F-85
Flexible reamer w/ flexible guide pin, 9 mm	AR-1400F-90
Flexible reamer w/ flexible guide pin, 9.5 mm	AR-1400F-95
Flexible reamer w/ flexible guide pin, 10 mm	AR-1400F-100
Flexible reamer w/ flexible guide pin, 10.5 mm	AR-1400F-105
Flexible reamer w/ flexible guide pin, 11 mm	AR-1400F-110

Flexible Reamer (a) w/ Flexible TightRope® Pin (c)

Product Description	Item Number
Flexible reamer w/ flexible TightRope pin, 7 mm	AR-1401F-70
Flexible reamer w/ flexible TightRope pin, 7.5 mm	AR-1401F-75
Flexible reamer w/ flexible TightRope pin, 8 mm	AR-1401F-80
Flexible reamer w/ flexible TightRope pin, 8.5 mm	AR-1401F-85
Flexible reamer w/ flexible TightRope pin, 9 mm	AR-1401F-90
Flexible reamer w/ flexible TightRope pin, 9.5 mm	AR-1401F-95
Flexible reamer w/ flexible TightRope pin, 10 mm	AR-1401F-100
Flexible reamer w/ flexible TightRope pin, 10.5 mm	AR-1401F-105
Flexible reamer w/ flexible TightRope pin, 11 mm	AR-1401F-110

Reusable Instruments

Product Description	Item Number
Flexible screw tap, 7 mm	AR-1998CTF-07
Flexible screw tap, 8 mm	AR-1998CTF-08
Flexible screw tap, 9 mm	AR-1998CTF-09
Flexible screw tap, 10 mm	AR-1998CTF-10
Flexible screwdriver shaft for 20 mm biocomposite and PEEK screws	AR-1996FD-1
Curved guide for flexible pins	AR-1800F
Pin puller	AR-1298P

Flexible Guide Pins (w/o Reamer)

Product Description	Item Number
Flexible TightRope drill pin for flexible reamer	AR-1298FLX
Flexible guide pin for flexible reamer	AR-1400FLX

Reference

- Swiontkowski M, Resnick L. Avoiding flexible reamer breakage during anatomic ACL reconstruction. *JBJS Case Connect.* 2014;4(4):e94. doi:10.2106/JBJS.CC.N.00174

Transportal ACL Guides



The transportal ACL guides (TPGs) were designed specifically for the anteromedial portal approach and allow surgeons freedom in femoral socket placement while maintaining appropriate backwall thickness. The open-angled offset tip allows more reproducible backwall thickness and facilitates anterior trajectory of the guide pin. It is also ideal for maintaining divergence of sockets in double-bundle ACL reconstruction. The longer tip stabilizes the guide over the posterior cortex during hyperflexion.

Available in 4 mm through 8 mm sizes, the larger exit cannulation of the TPGs allows room for the spade tip of the RetroButton® pin to rotate.

Product Description	Item Number
Transportal ACL Guide (TPG), 4-8 mm	AR-1800-04 – 08

Transtibial Femoral Guides



A series of offset guides allows precise anatomical placement of femoral tunnels by referencing the over-the-top position. Five sizes (4 mm to 8 mm offsets) provide a 1 mm to 2 mm tunnel backwall when used with the appropriate size reamer. For example, a 7 mm offset transtibial femoral ACL drill guide (TTG) used with a 10 mm-diameter reamer leaves a 2 mm backwall. Disposable plastic backflow caps (in the transtibial ACL disposables kits) are designed to eliminate annoying leakage of irrigation fluid through the cannulated handle during positioning and guide pin placement. Guide pins are simply drilled through the plastic cap.

Transtibial Femoral Guides

Product Description	Item Number
Transtibial femoral ACL drill guide (TTG), 4 mm (6-7 mm tunnels)	AR-1806
Transtibial femoral ACL drill guide (TTG), 5 mm (7-8 mm tunnels)	AR-1803
Transtibial femoral ACL drill guide (TTG), 6 mm (8-9 mm tunnels)	AR-1804
Transtibial femoral ACL drill guide (TTG), 7 mm (9-10 mm tunnels)	AR-1801
Transtibial femoral ACL drill guide (TTG), 8 mm (10-11 mm tunnels)	AR-1805

Low-Profile Reamers



Low-profile reamers facilitate femoral socket preparation through the medial portal and allow greater flexibility in femoral socket placement for transtibial procedures. The reamer's extra thin shaft and "2-flute" design provide a flat profile that easily passes through the portal and avoids damaging the femoral condyle and PCL. The reduced length of the flutes allows the drill to spin without contacting PCL fibers. Low-profile reamers may be used with the Arthrex transportal ACL guides for anatomic guide pin placement through the medial portal.

Product Description	Item Number
Low-profile reamers, 5 mm	AR-1405LP
Low-profile reamers, 6 mm	AR-1406LP
Low-profile reamers, 7 mm	AR-1407LP
Low-profile reamers, 8 mm	AR-1408LP
Low-profile reamers, 9 mm (a)	AR-1409LP
Low-profile reamers, 10 mm	AR-1410LP
Low-profile reamers, 11 mm	AR-1411LP

Cannulated Headed Reamers

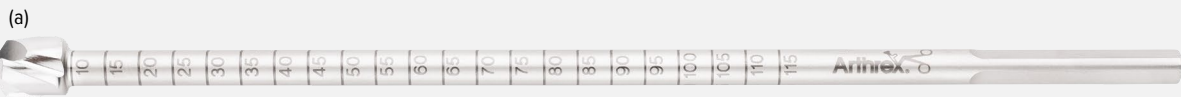

A series of offset guides allows precise anatomical placement of femoral tunnels by referencing the over-the-top position. Five sizes (4 mm to 8 mm offsets) provide a 1 mm to 2 mm tunnel backwall when used with the appropriate size reamer. For example, a 7 mm offset transtibial femoral ACL drill guide (TTG) used with a 10 mm-diameter reamer leaves a 2 mm backwall. Disposable plastic backflow caps (in the transtibial ACL disposables kits) are designed to eliminate annoying leakage of irrigation fluid through the cannulated handle during positioning and guide pin placement. Guide pins are simply drilled through the plastic cap.

Product Description	Item Number
Cannulated headed reamer, 5 mm	AR-1405
Cannulated headed reamer, 6 mm	AR-1406
Cannulated headed reamer, 7 mm	AR-1407
Cannulated headed reamer, 8 mm	AR-1408
Cannulated headed reamer, 9 mm	AR-1409
Cannulated headed reamer, 10 mm (a)	AR-1410
Cannulated headed reamer, 11 mm	AR-1411
Cannulated headed reamer, 12 mm	AR-1412
Cannulated headed reamer, 13 mm	AR-1413
Cannulated headed reamer, 14 mm	AR-1414

Coring Reamers



The Coring Reamer System is designed to harvest a cylinder of cancellous bone while simultaneously creating the tibial tunnel. The harvested core can be used to fill the patellar tendon harvest site or to fill tunnels during ACL/PCL revision procedures.

Before inserting the collared pin, drill the distal tunnel up to a depth of 10 mm with a cannulated drill that is 1 mm larger in diameter than the selected coring reamer. The pin positioner facilitates simplified collared pin exchange. Drill the coring reamer over the collared pin for directional control and subsequent bone core removal.

Coring reamers are also available in 13 mm- and 14 mm-diameters for retightening intact ACL graft, which is executed by cutting around the tibial insertion of the graft. Pull the tibial bone core distally and secure with an interference screw.

Product Description	Item Number
Coring reamer and collared pin set, 7 mm	AR-1220S
Coring reamer and collared pin set, 8 mm	AR-1222S
Coring reamer and collared pin set, 9 mm	AR-1223S
Coring reamer and collared pin set, 10 mm	AR-1224S
Coring reamer and collared pin set, 11 mm	AR-1226S
Coring reamer and collared pin set, 12 mm	AR-1227S
Coring reamer and collared pin set, 13 mm	AR-1229S
Coring reamer and collared pin set, 14 mm	AR-1231S

Cannulated and Sterile Cannulated Drill



Full-thickness cannulated drills with graduated depth marks are designed specifically for ACL tibial tunnels, PCL tibial and femoral tunnels, and standard 2-incision ACL reconstruction procedures. The optional drill sleeves help protect soft tissue during drilling.

Cannulated Drills

Product Description	Item Number
Cannulated drill, 4 mm	AR-1204L
Cannulated drill, 5 mm	AR-1205L
Cannulated drill, 6 mm	AR-1206L
Cannulated drill sleeve, 6 mm	AR-1206S
Cannulated drill, 7 mm	AR-1207L
Cannulated drill sleeve, 7 mm	AR-1207S
Cannulated drill, 8 mm	AR-1208L
Cannulated drill sleeve, 8 mm	AR-1208S
Cannulated drill, 9 mm	AR-1209L
Cannulated drill sleeve, 9 mm	AR-1209S
Cannulated drill, 10 mm	AR-1214L
Cannulated drill sleeve, 10 mm	AR-1214S
Cannulated drill, 11 mm	AR-1217L
Cannulated drill sleeve, 11 mm	AR-1217S
Cannulated drill, 12 mm	AR-1221L
Cannulated drill sleeve, 12 mm	AR-1221S
Cannulated drill, 15 mm	AR-1215L
Cannulated drill sleeve, 15 mm	AR-1215S
Drill tip guide pin, 2.4 mm, qty. 6	AR-1250L

For customers who prefer single-use instrumentation, Arthrex offers full-thickness cannulated drills that are packaged sterile.

Sterile Cannulated Drills

Product Description	Item Number
Cannulated drills, 4-15 mm (including half sizes)	AR-1218-40 – 150

Tunnel Dilators

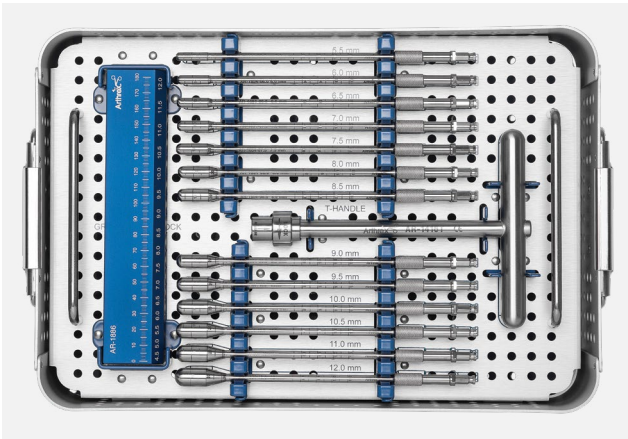

For surgeons who prefer bone compaction versus removal, the cannulated tunnel dilators provide guidewire-directed tunnel dilation in half-millimeter increments. The quick connect T-handle easily attaches to dilators, allowing for fast changes from one dilator size to the next.

ACL Tunnel Preparation Instrumentation Set (AR-1856S)

Product Description	Item Number
Quick-connect T-handle	AR-1416T
Tunnel dilators, 5.5-12 mm (0.5 mm increments)	AR-1854-05.5 – 12.0
ACL tunnel preparation instrumentation case	AR-1856
Graft sizing block	AR-1886

Notchplasty



The curved tunnel/notchplasty rasp is ideal for completing the notchplasty and chamfering of the tibial and femoral tunnel rim. Designed specifically for rasping or smoothing tunnel rims after drilling to reduce graft abrasion or laceration, the rasp fits easily through the tibial tunnel cannula in an 8 mm tunnel. The offset shaft of the notchplasty osteotome provides easy access to the lateral wall of the intercondylar notch from the anteromedial portal for anatomical widening of the notch. The open ring curette, which is sharp on both sides, will help to perform the soft-tissue notchplasty to identify the over-the-top position.

Product Description	Item Number
Tunnel/notchplasty rasp (a)	AR-1282
Notchplasty and graft harvesting osteotome, 5 mm (b)	AR-1830
Ring curette, 5.4 mm, one side cut (c)	AR-20010
Ring curette, 5.4 mm, both sides cut	AR-20020

ACL/PCL Accessories

ACL Disposables Kits	24
ACL/PCL Graft Passing Forceps	25

ACL Disposables Kits

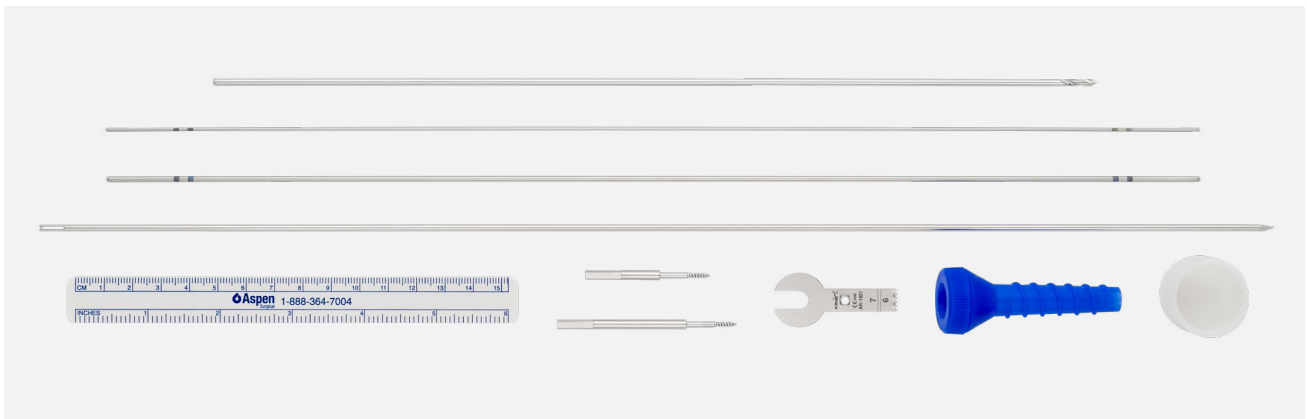

The single-use ACL disposables kits and convenience packs provide a convenient, sterile, and complete set of the guide pins and disposables required for ACL reconstruction.

Transtibial ACL Disposables Kit w/ Hall Style Saw Blade, qty. 5

Product Description	Item Number
Graft Harvesting Kit	AR-1897S
<ul style="list-style-type: none"> ■ 2.4 mm guide pin w/ suture eye ■ 2.4 mm drill tip guide pin ■ 1.1 mm nitinol guide pin for Bio-Interference screw ■ 2.0 mm nitinol guide pin w/ 25 mm and 30 mm depth markings ■ Tibial tunnel cannula, backflow cap, 153 mm marking ruler 	

Transtibial ACL Disposables Kit w/o Saw Blade, qty. 5

Product Description	Item Number
Transtibial ACL Disposables Kit	AR-1898S
<ul style="list-style-type: none"> ■ 2.4 mm guide pin w/ suture eye ■ 2.4 mm drill tip guide pin ■ 1.1 mm nitinol guide pin for Bio-Interference screw ■ 2.0 mm nitinol guide pin w/ 25 mm and 30 mm depth markings ■ Tibial tunnel cannula, backflow cap, 153 mm marking ruler 	

ACL All-Inside Disposables Kit

Product Description	Item Number
ACL All-Inside Disposables Kit	AR-1587S
<ul style="list-style-type: none"> ■ Shoehorn cannula ■ RetroButton® drill pin ■ #2 FiberStick™ and #2 TigerStick® suture ■ #2 FiberLoop® and #2 TigerLoop™ suture ■ Suture passing wire ■ 1.1 mm nitinol guide pin for Bio-Interference screw ■ 153 mm marking ruler ■ ACL TightRope® drill pin, closed eyelet 	

ACL/PCL Graft Passing Forceps



The ACL/PCL graft forceps are designed for atraumatic manipulation of the graft intra-articularly during graft passing. The smooth, curved jaws provide excellent rotational control of the graft during insertion into femoral tunnels and also for large loose body removal.

The SR series graspers feature a self-releasing lock mechanism that can be easily disengaged by simply moving the handles apart. The NR series graspers have nonlocking handles for easy use in difficult hand positions encountered during surgery.

Graft Passing Forceps

Product Description	Item Number
ACL/PCL graft passing forceps w/ SR handle	AR-13400SR
ACL/PCL graft passing forceps w/ NR handle	AR-13400NR

Soft-Tissue Graft Harvesting

QuadPro™ Tendon Harvester	28
Minimally Invasive Quad Tendon System.....	29
Atraumatic Hamstring Harvester	30
Hamstring Tendon Strippers	30
Minimally Invasive Hamstring Harvesting Set.....	31
Hamstring Donor Site Delivery Tube	31

QuadPro™ Tendon Harvester



Developed from Arthrex's commitment to Helping Surgeons Treat Their Patients Better™ the QuadPro tendon harvester was engineered to allow for efficient, minimally invasive graft harvesting while reducing the morbidity and challenges associated with traditional harvesting techniques.

Quadricep tendon grafts offer unique benefits for cruciate ligament reconstruction, such as a predictably larger diameter, low morbidity,¹ and a preferable stiffness profile.²

Reproducible Graft Sizing

- Available in various sizes for appropriate graft diameter (8 mm, 9 mm, 10 mm, and 11 mm)
- Sharp cylindrical tip harvests a round, true-to-size graft
- Clear handle with graduations to determine graft length

Minimally Invasive Technique

- Minimal incision and dissection required
- Reduces procedure time and graft site morbidity

Graft Amputation

- Graft retrieved through amputation window in device after harvesting
- Sharp cutting edge in window amputates graft when push rod is completely deployed

QuadPro Tendon Harvester Kit

Product Description	Item Number
QuadPro tendon harvester, 8 mm	AR-2386-08
QuadPro tendon harvester, 9 mm	AR-2386-09
QuadPro tendon harvester, 10 mm	AR-2386-10
QuadPro tendon harvester, 11 mm	AR-2386-11

QuadPro Tendon Harvester and FiberTag® TightRope® Implant System Kit

Product Description	Item Number
ACL FiberTag TightRope implant system, 8 mm	AR-1288QT-80
ACL FiberTag TightRope implant system, 9 mm	AR-1288QT-90
ACL FiberTag TightRope implant system, 10 mm	AR-1288QT-100
ACL FiberTag TightRope implant system, 11 mm	AR-1288QT-110

QuadLink™ Implant Systems

Product Description	Item Number
Each QuadLink Kit includes: QuadPro Tendon Harvester, FiberTag TightRope implant, FiberTag TightRope ABS implant, 11 mm round concave ABS button, FlipCutter® III drill, PassPort Button™ cannula, FiberStick™ and TigerStick® sutures, and FiberWire® and TigerWire® sutures	
QuadLink implant system, 8 mm	AR-1288QIS-80
QuadLink implant system, 9 mm	AR-1288QIS-90
QuadLink implant system, 10 mm	AR-1288QIS-100
QuadLink implant system, 11 mm	AR-1288QIS-110

References

1. Buescu CT, Onutu AH, Lucaciu DO, Todor A. Pain level after ACL reconstruction: a comparative study between free quadriceps tendon and hamstring tendons autografts. *Acta Orthop Traumatol Turc.* 2017;51(2):100-103. doi:10.1016/j.aott.2017.02.011
2. Shani RH, Umpierrez E, Nasert M, Hiza EA, Xerogeanes J. Biomechanical comparison of quadriceps and patellar tendon grafts in anterior cruciate ligament reconstruction. *Arthroscopy.* 2016;32(1):71-75. doi:10.1016/j.arthro.2015.06.051

Minimally Invasive Quad Tendon System



Designed based on published anatomic studies, the Minimally Invasive Quad Tendon Harvest System allows surgeons to efficiently harvest a graft of a desired length and diameter through a small incision. The system has the versatility to create grafts that meet surgeons' soft-tissue, bone-soft tissue, all-inside, and transtibial needs.

Minimally Invasive Quad Tendon Set (AR-2382S)

Product Description	Item Number
Quad tendon graft cutting guide	AR-2383
Quad tendon stripper/cutter (a)	AR-2384
Instrument case	AR-2382C

Disposable Blades for Quad Tendon Graft Cutting Guide

Product Description	Item Number
Quad tendon graft cutting blade, 9 mm	AR-2385-09
Quad tendon graft cutting blade, 10 mm	AR-2385-10
Quad tendon graft cutting blade, 11 mm	AR-2385-11

Atraumatic Hamstring Harvester



The new atraumatic tendon harvester facilitates minimally invasive harvesting from an anterior or posterior incision. Easily load hamstring tendons with the opening/closing tip. The smooth edge bluntly dissects the tendon away from muscle, limits the chance of premature tendon amputation, and potentially decreases patient morbidity.

Product Description	Item Number
Atraumatic hamstring harvester	AR-10300

Hamstring Tendon Strippers

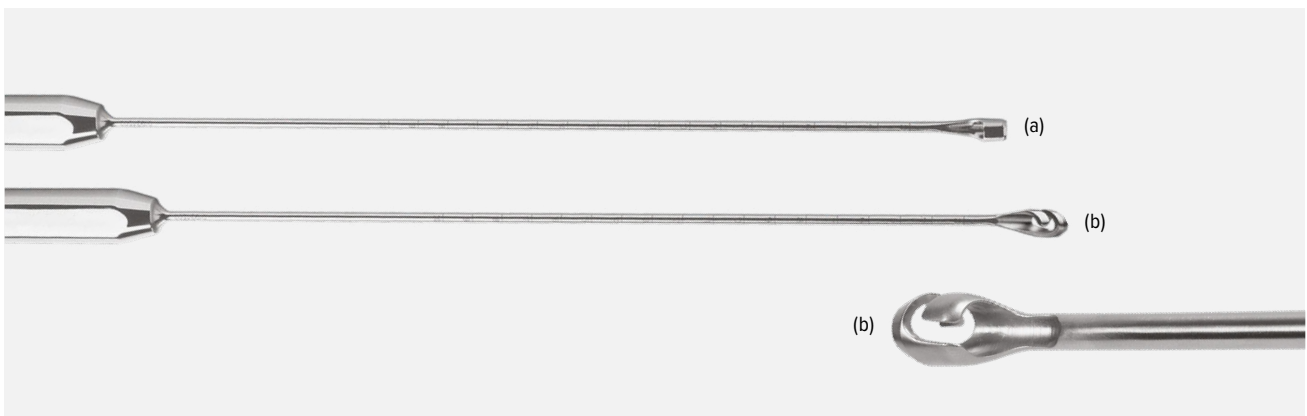

The 5 mm and 7 mm-diameter hamstring tendon strippers provide maximum tendon length with less soft-tissue trauma through a small incision just medial to the tibial tubercle. While harvesting, use the graduations on the shaft to determine graft length. The spiral end of the “pigtail” facilitates capture of distally attached tendons for proximal subcutaneous stripping of hamstring grafts.

Product Description	Item Number
Semitendinosus stripper, 5 mm diameter	AR-1278
Semitendinosus stripper, 7 mm diameter (a)	AR-1278L
Pigtail hamstring tendon stripper, 5 mm diameter, open end (b)	AR-1278P
Pigtail hamstring tendon stripper, 7 mm diameter, open end	AR-1278PL

Minimally Invasive Hamstring Harvesting Set

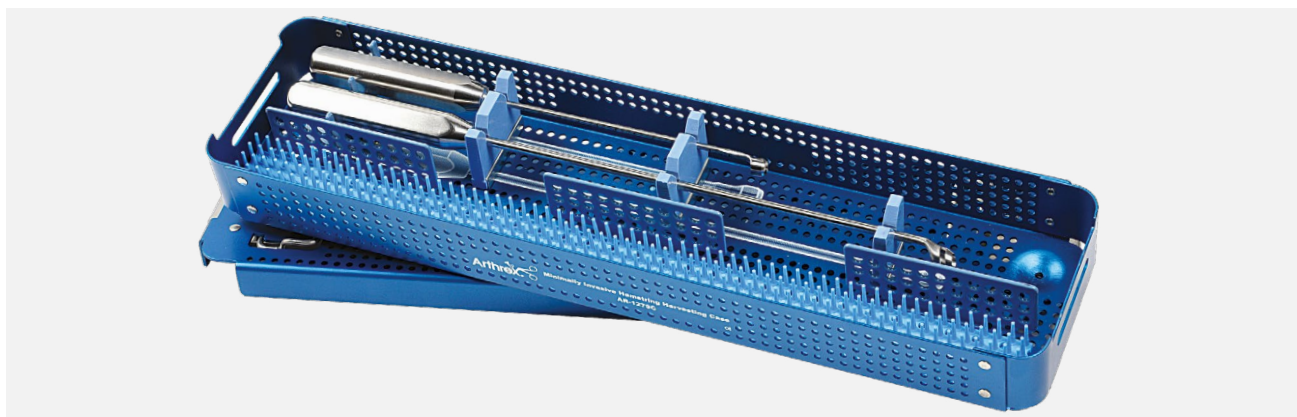

The minimally invasive hamstring harvest technique enables removal of the hamstring tendons through a small posteromedial incision. Because the hamstring tendons lie more superficial in the popliteal crease, they are easily exposed and released from proximal attachments. The small incision required also improves cosmesis and may decrease post-op morbidity.¹ The set includes two harvesters made especially for this minimally invasive technique. The shorter, stiff shaft facilitates harvesting from the posteromedial incision. The open harvester is large enough to load the thicker, more proximal portion of the hamstring tendons. The closed distal harvester is slightly sharper, permitting elevation of the tendons off the tibial insertion.

Keeping the knee flexed and the hip externally rotated, perform the mini hamstring harvest without changing position from the standard preparation for ACLR.

Minimally Invasive Hamstring Harvesting Set (AR-1279S)

Product Description	Item Number
Minimally invasive graft harvester, open	AR-1278PL
Semitendinosus tendon stripper, 150 mm	AR-1279L
Instrument case	AR-1279C

Reference

1. Franz W, Ulbrich J. A new technique for harvesting the semitendinosus tendon for cruciate ligament reconstruction. Article in German. *Arthroskopie*. 2004;17(2):104-107. doi:10.1007/s00142-004-0255-1

Hamstring Donor Site Delivery Tube

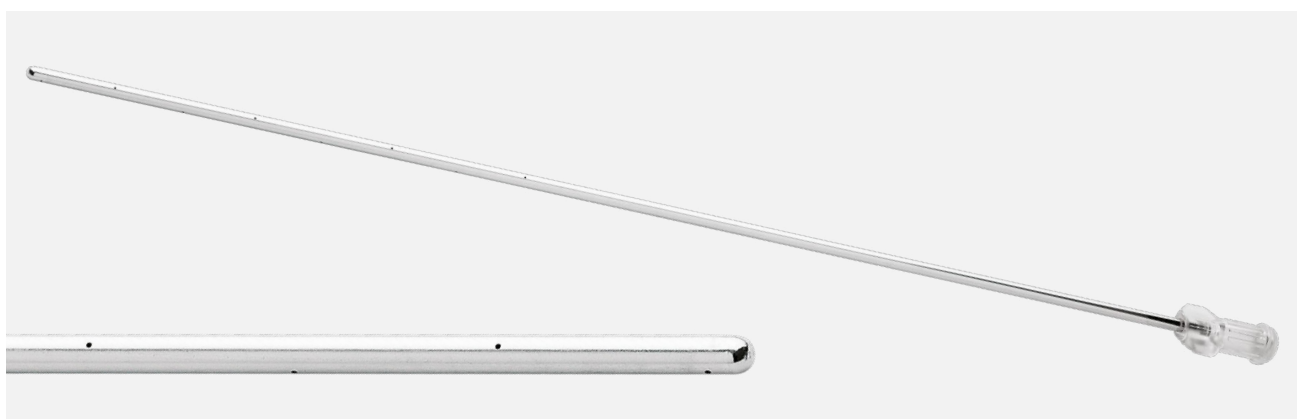

The hamstring donor site delivery tube, which is used while harvesting a hamstring during autograft ACL surgery, allows delivery of an anesthetic to the donor site. The overall length of the tube is 247 mm. The distal 90 mm section features 16 fenestrations in an offset pattern to effectively deliver anesthetic over a wide area. The Luer lock accepts a standard syringe.

Product Description	Item Number
Hamstring donor-site delivery tube, single pack	AR-1280-01
Hamstring donor-site delivery tube, 5/pack	AR-1280

BTB Graft Harvesting

Parallel Graft Knife for Patella Tendon Harvest.....	34
Graft Harvesting Cutting Guides and Saw Blades	34
Graft Harvesting Osteotome.....	35
Graft Harvesting Retractor.....	35
ACL Graft Shaper.....	35

Parallel Graft Knife for Patella Tendon Harvest

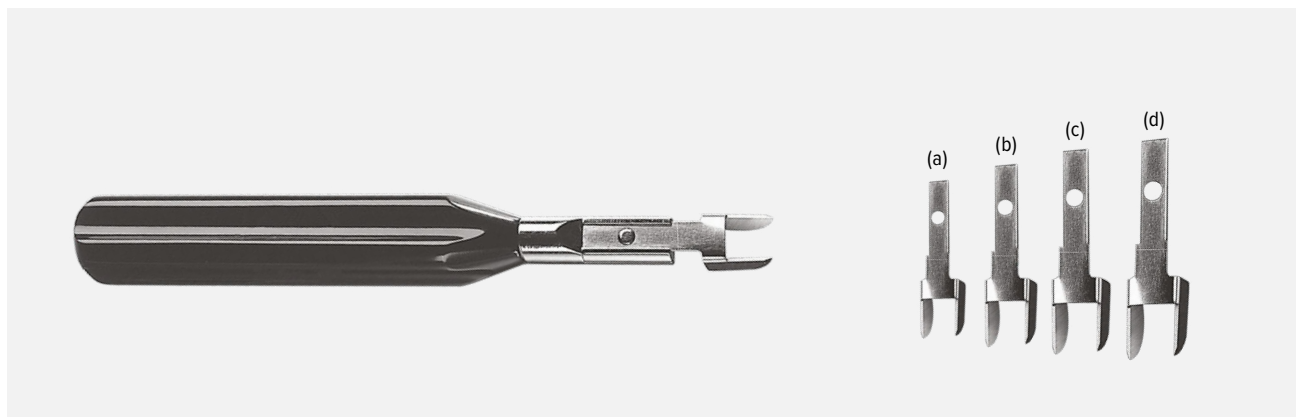

The parallel graft knife is designed for harvesting the patellar or quadriceps tendon for use during ACL/PCL reconstruction. The parallel blades create a precise cut in a single pass. The reusable handle provides a convenient, cost-effective alternative to disposable devices. Special single-use blade packaging allows easy, safe blade attachment and removal.

Product Description	Item Number
Parallel Graft Knife Handle	AR-2285H
Parallel Graft Knife Blades, 8 mm (a)	AR-2285-08
Parallel Graft Knife Blades, 9 mm (b)	AR-2285-09
Parallel Graft Knife Blades, 10 mm (c)	AR-2285-10
Parallel Graft Knife Blades, 11 mm (d)	AR-2285-11

Graft Harvesting Cutting Guides and Saw Blades



Used to harvest an ideal trapezoidal-shaped bone plug with predrilled suture holes from both the patella and the tibia, the cutting guides provide consistent, reproducible results during tendon harvest. Arthrex saw blades have the ideal width and tooth configuration for BTB graft harvesting. A mechanical depth stop provides a secure 7 mm depth control when used in conjunction with the graft harvesting cutting guide. Laser-etched graduations of 6 mm and 7 mm provide visual depth control during freehand saw harvesting.

Product Description	Item Number
Graft harvesting cutting guide, 8.5-10.5 mm width (1 mm increments)	AR-1809 – 11
Saw blade, Hall-style (3M-, Dyonics-, and Stryker-style blades also available)	AR-1821
Graft harvesting kit w/ Hall-style sagittal saw blade and 2 ea. threaded fixation pins, short and long	AR-1821S

Graft Harvesting Osteotome



The 8 mm-wide, offset osteotome is ideal for final harvesting of the patellar and tibial bone block from an inferior approach under the tendon after cortical bone resection.

Product Description	Item Number
Notchplasty and graft harvesting osteotome, 8 mm	AR-1830L

Graft Harvesting Retractor



When harvesting the central third of the patellar tendon, the graft harvesting retractor provides excellent exposure of the anterior aspect of the patella through a minimal incision of less than 6 cm. Hook the retractor's forked end over the superior pole of the patella and lever it to securely retract the surrounding skin and subcutaneous tissue.

The graft harvesting retractor can also be used for retraction of skin and soft tissue when drilling the tibial tunnel.

Product Description	Item Number
Graft harvesting retractor	AR-1420

ACL Graft Shaper



The ACL graft shaper is a unique bone “press” that shapes and compresses cancellous bone to accommodate a precise graft-fit into predrilled tibial and femoral tunnels during ACL/PCL reconstruction. The smooth, semicircular jaws compress the bone corners and edges, which inhibit smooth graft passing. An adjustable spacer in the handle provides controlled size compression of bone plugs to 8 mm, 9 mm, 10 mm, and 11 mm diameters. Side holes provide accurate placement of holes for graft-passing sutures with a 2 mm-diameter drill.

Product Description	Item Number
ACL graft shaper	AR-1234

FiberWire® Suture

FiberLoop® and TigerLoop™ Sutures	38
SutureTape Graft Preparation and Tissue Repair	39
FiberLink™ and TigerLink™ SutureTape.....	40
FiberSnare® Suture	40
FiberLink™ and TigerLink™ Suture.....	41
FiberTape® Suture	41
FiberLoop® With FiberTag® Suture.....	42
Suture Tensioner With Tensiometer.....	43

FiberLoop® and TigerLoop™ Sutures

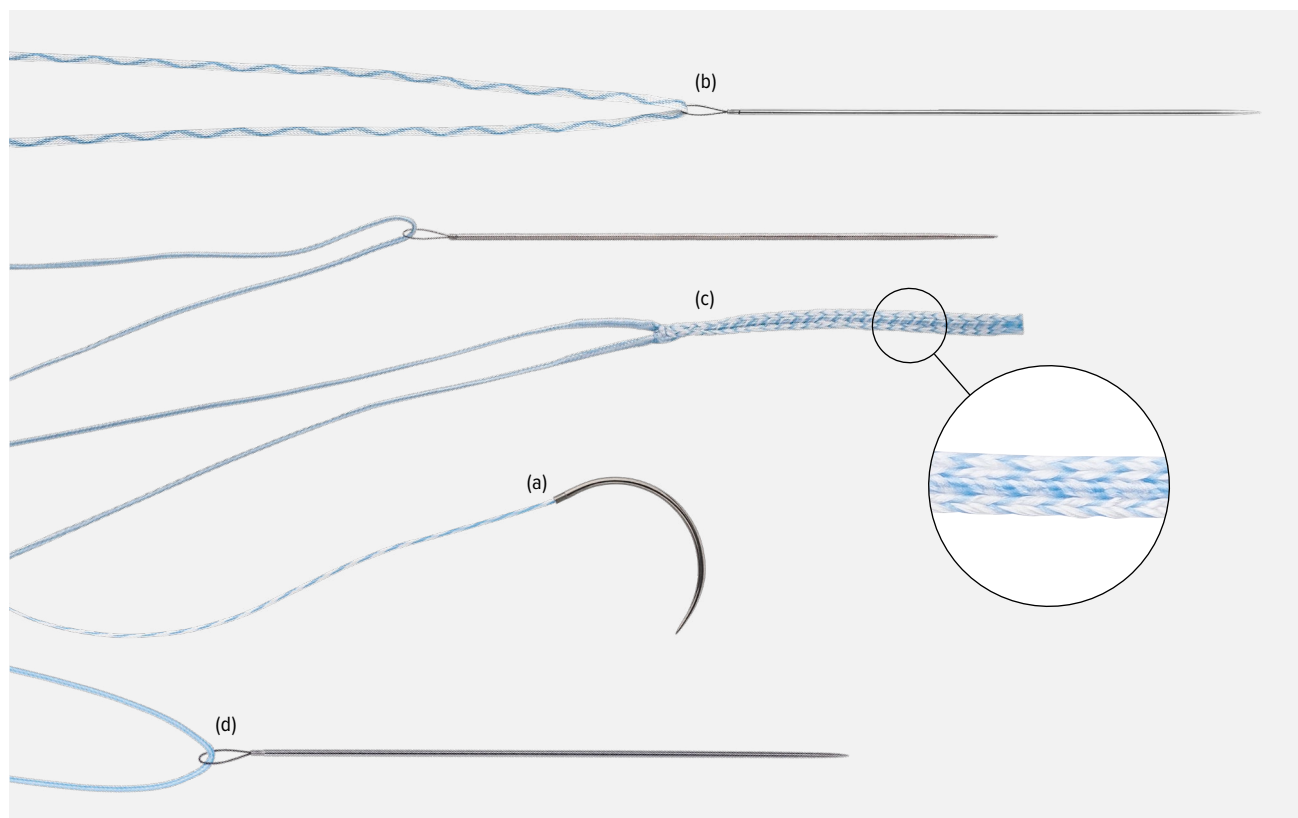

More than a decade ago, Arthrex launched the innovative FiberLoop suture and SpeedWhip™ technique that revolutionized graft preparation, making it simpler, faster, and stronger than standard whipstitching techniques.¹ Since then, more than 2 million grafts have been prepared with FiberLoop suture.² The FiberWire® suture graft preparation product line has grown to more than a dozen different options for varying applications and surgeon preferences.

LoopLink Suture

Product Description	Item Number
LoopLink suture (a)	AR-7524C

SutureTape FiberLoop Suture

Product Description	Item Number
SutureTape FiberLoop, 0.9 mm, with one straight tapered needle, (White/Blue)	AR-7524
FiberLoop SutureTape, 1.3 mm, 20 in loop (white/blue) w/ 76 mm straight needle, 12/box (b)	AR-7534
TigerLoop SutureTape, 1.3 mm, 20 in loop (white/black) w/ 76 mm straight needle, 12/box	AR-7534T

FiberLoop With FiberTag® Suture

Product Description	Item Number
FiberLoop w/ FiberTag® suture, looped straight needle (c)	AR-7264
FiberLoop w/ FiberTag suture, swaged-on straight needle	AR-7266

#2 FiberLoop Suture

Product Description	Item Number
#2 FiberLoop suture w/ straight needle, 20 in (blue), 76 mm needle w/ 7 mm loop, collagen coated	AR-7234B
#2 FiberLoop suture w/ straight needle (blue) (d)	AR-7234
#2 TigerLoop suture w/ straight needle, w/ TigerWire® suture	AR-7234T
#2 FiberLoop suture w/ curved needle, 20 in (blue), ½ circle	AR-7234C
#2 FiberLoop suture w/ swaged straight needle	AR-7284

#0 FiberLoop Suture

Product Description	Item Number
0 FiberLoop suture w/ straight needle, 13 in (blue), 76 mm needle w/ 7 mm loop	AR-7253
0 TigerLoop suture w/ straight needle, 13 in (white/black), 76 mm needle w/ 7 mm loop	AR-7253T

Reference

- Ostranderv RV 3rd, Saper MG, Juelson TJ. A biomechanical comparison of modified Krackow and locking loop suture patterns for soft-tissue graft fixation. *Arthroscopy*. 2016;32(7):1384-1388. doi:10.1016/j.arthro.2016.01.054
- Arthrex, Inc. Data on file (sales data as of September 17, 2018). Naples, FL; 2018.

SutureTape Graft Preparation and Tissue Repair

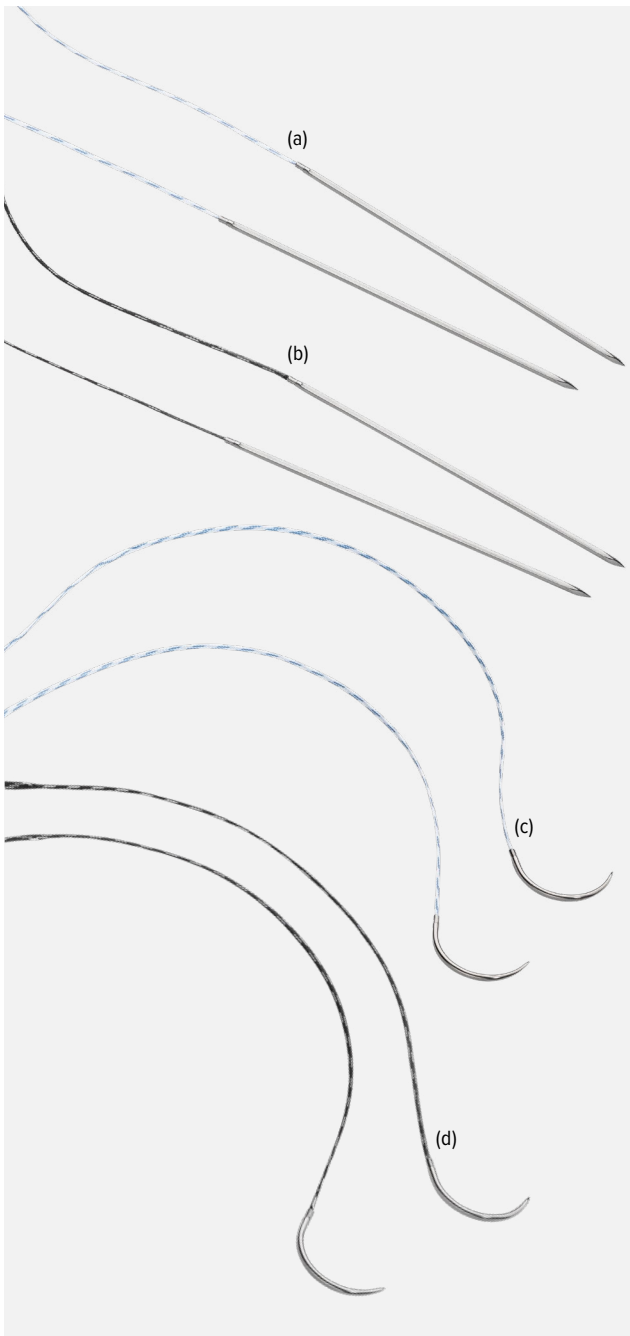

SutureTape FiberLoop and TigerLoop sutures are continuous loops of either 0.9 mm or 1.3 mm SutureTape with tapered straight needles. After passing through tissue and facilitating even tension, the easy-to-handle straight needle moves freely on the suture to reset itself.

Product Description	Item Number
SutureTape, 0.9 mm	AR-7521
SutureTape, 0.9 mm, w/ two 36.6 mm half-curved tapered needles, (white/blue)	AR-7571-02
SutureTape, 1.3 mm, w/ two straight needles, (white/blue) (a)	AR-7546-02
SutureTape, 1.3 mm, w/ two straight needles, (black/white) (b)	AR-7546TT-02
SutureTape, 1.3 mm, w/ two 26.5 mm half-curved tapered needles, (white/blue) (c)	AR-7505
SutureTape, 1.3 mm, w/ two 26.5 mm half-curved tapered needles, (black/white) (d)	AR-7505TT-02
SutureTape, 1.3 mm, w/ two 36.6 mm half-curved tapered needles, (white/black)	AR-7531-02

FiberLink™ and TigerLink™ SutureTape



FiberLink and TigerLink SutureTape includes a 0.9 mm SutureTape link with a 24 in tail of 2-0 FiberWire® suture. FiberLink SutureTape is solid blue and TigerLink SutureTape is white with black stripes to aid with suture management. Each product is packaged in a box of 12.

Product Description	Item Number
FiberLink SutureTape	AR-7559
TigerLink SutureTape	AR-7559T

FiberSnare® Suture

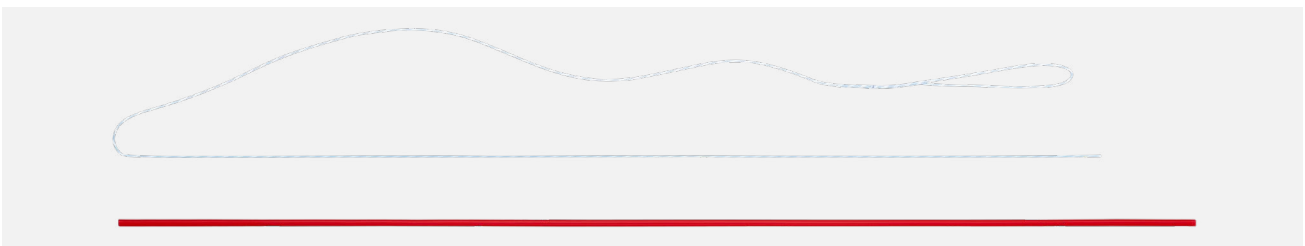

The new larger loop FiberSnare suture was specifically engineered for convenience and ease of use when shuttling sutures during ligament reconstruction and repair procedures. The FiberSnare suture has an overall working length of 26 inches and the construct consists of a #2 FiberWire® suture with a 2 in loop on one end while the opposite end is stiffened 12 in. FiberSnare sutures can be used for both retrograde (outside-in) or antegrade (inside-out) drilling techniques as a shuttling suture. The new unique color patterns (black/white and white/blue striped suture) also allow for easier suture identification and management.

Product Description	Item Number
#2 FiberSnare w/ #2 FiberWire braided polyblend suture, white/blue w/ closed loop, 26 in, one end stiffened, 12 in	AR-7209SNL
#2 FiberSnare w/ #2 FiberWire braided polyblend suture, black/white w/ closed loop, 26 in, one end stiffened, 12 in	AR-7209SNT

FiberLink™ and TigerLink™ Suture



The 0 FiberLink suture construct includes an overall length of 24 in of blue FiberWire® suture with a 1.5 in closed loop. A 0 TigerLink suture, white with black stripes, is also available. Each product is packaged in a box of 12.

Product Description	Item Number
0 FiberLink suture, FiberWire suture w/ 1.5 in closed loop at one end (blue)	AR-7258
0 TigerLink suture, TigerWire® suture w/ 1.5 in closed loop at one end (white/black)	AR-7258T

FiberTape® Suture



FiberTape suture is an ultrahigh-strength, 2 mm-wide tape using the long-chain polyethylene structure of FiberWire suture. FiberTape suture's broad footprint is appropriate for repairs of degenerative tissue where tissue pull-through may be a concern.

Product Description	Item Number
FiberTape suture, 2 mm, 38 in (blue), each end tapered to #2 FiberWire suture, 8 in (total length 54 in)	AR-7237

FiberLoop® With FiberTag® Suture



The SpeedWhip™ rip-stop technique eliminates the weak link in graft preparation by reinforcing the suture-tissue interface with FiberTag suture. The FiberTag suture acts as a ripstop when placing each needle pass with the FiberLoop suture, incorporating both the graft and suture. This construct has been shown to increase the strength over standard stitching alone.¹

Product Description	Item Number
FiberLoop w/ FiberTag suture	AR-7264
#2 FiberLoop w/ FiberTag suture w/ swaged-on straight needle	AR-7266

Reference

1. Arthrex, Inc. LA1-00005-EN. Naples, FL; 2015.

Suture Tensioner With Tensiometer

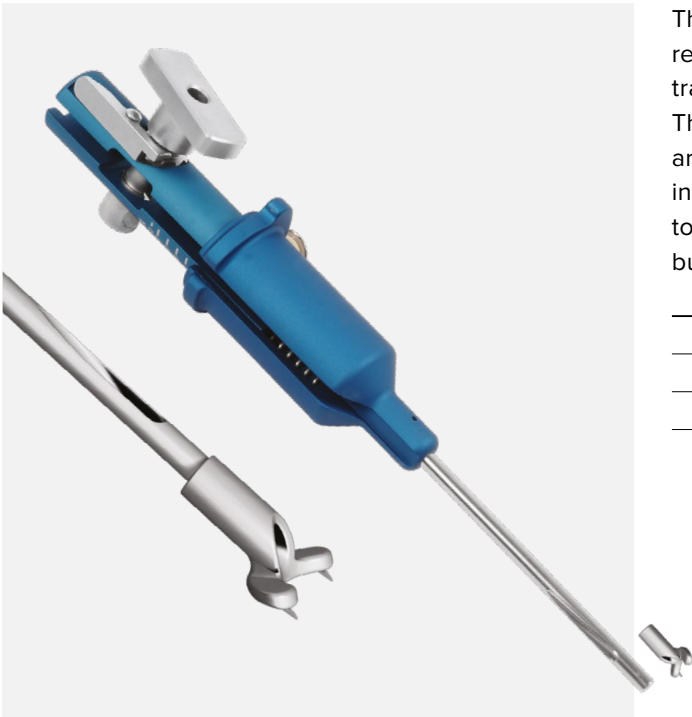

The suture tensioner with tensiometer allows simple, reproducible graft tensioning intraoperatively for both transtibial and all-inside ACL/PCL reconstruction. The footpiece may be used to secure the tensioner around the tibial tunnel, allowing placement of an interference screw during tensioning. Remove the foot to simultaneously tension and tie graft sutures over a button or suture post.

Product Description	Item Number
Suture tensioner w/ tensiometer	AR-1529
Tensiometer foot	AR-1530

Graft Prep, Sizing, and Pretensioning

GraftPro® Graft Preparation System	46
Graft Tubes	47

GraftPro® Graft Preparation System

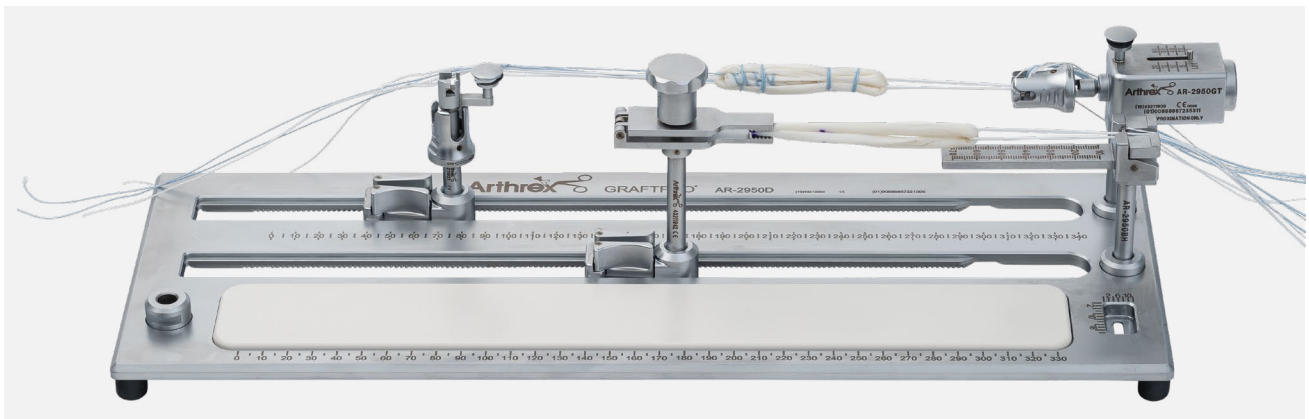

The GraftPro system brings graft preparation and tensioning to a new level of simplicity and convenience. The unique ratcheting adjustment track system allows one-handed movement of attachments along the length of the board and locks them into place automatically.

All attachments are interchangeable from the adjustable tracks to the fixed positions. Two parallel rails allow simultaneous preparation and tensioning of two grafts at a time or a single double-bundle graft.

The BTB well facilitates stable cutting of patella tendon bone blocks to size and drilling of suture holes through the board. Enhanced attachments hold a variety of implants and grafts in place firmly and atraumatically.

GraftPro Graft Preparation Set (AR-2950DS)

Product Description	Item Number
GraftPro case	AR-2950DC
GraftPro board	AR-2950D
GraftPro posts, qty. 2 (a)	AR-2950AP
GraftPro GraftLink tensioner (b)	AR-2950GT
GraftPro GraftLink holder (c)	AR-2950GH
GraftPro button holder (d)	AR-2950BH
GraftPro soft-tissue clamps, qty. 2 (e)	AR-2950SC
Graft sizing block	AR-1886

Optional

Product Description	Item Number
Cutting board clamp	AR-2950CBC

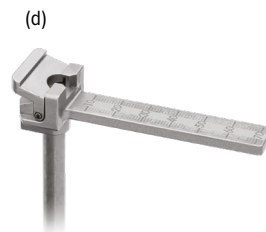
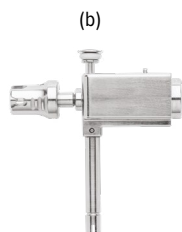
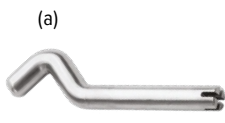

Graft Tubes

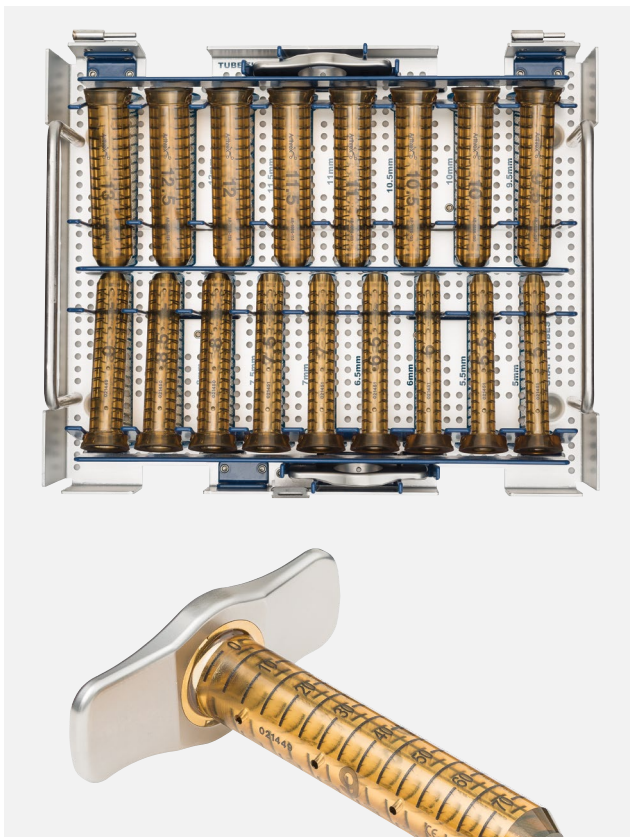

The full-circumference, full-length, clear graft tubes facilitate graft compression, sizing, and preparation. These unique transparent tubes with an etched ruler allow visualization of the graft during diameter and length sizing. The funneled entrance and attachable handle ease the entry of grafts into the sizer for up to 2 mm of compression. Small holes in the graft tubes allow hydration of the graft or injection of biologics along the entire length. Use the tapered tip to deliver the graft directly into the tibial tunnel or medial portal. The graft tube set comes in diameters of 6 mm to 13 mm, including half-sizes. The low-profile instrumentation tray can be processed independently or placed inside the RetroConstruction™ drill guide instrument set.

Graft Tube Set (AR-1886-S)

Product Description	Item Number
Graft tubes, 5-13 mm	AR-1886-050 – 130
Graft tube flange	AR-1886-001
Graft tube instrumentation case	AR-1886C

Graft Fixation

FiberTag® TightRope® II Implant.....	50
ACL TightRope® II RT Implant	51
GraftLink® Implant System.....	52
ACL TightRope® II BTB Implant	53
ACL TightRope® II ABS and ABS Buttons.....	54
TightRope Button Extender.....	54
FastThread™ BioComposite Interference Screw	55
FastThread™ PEEK Interference Screw.....	56
GraftBolt® Implant.....	57
Suture Buttons.....	58
RetroButton® XL Implant	58
RetroButton® Implant.....	58
ACL Backup Fixation Kits	59
ACL/PCL Cortical Fixation Set.....	60

FiberTag® TightRope® II Implant

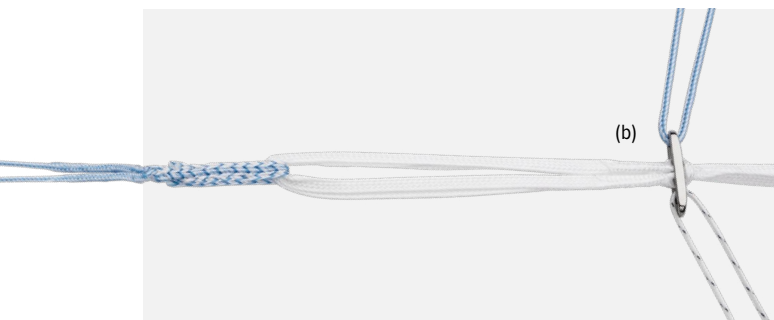
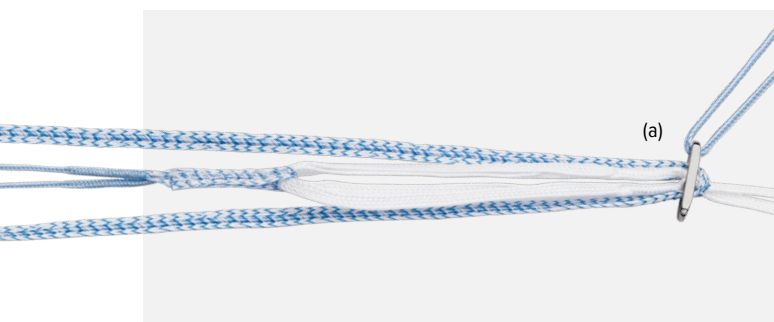

The FiberTag TightRope II implant adds optimized features to the revolutionary FiberTag TightRope implant design. New shorter locking splices create a shorter minimum loop length to maximize the amount of graft in the socket. A flat-tape loop and tensioning strands improve strength, feel, and handling.¹

Additionally, the FiberTag TightRope II implant is available with a preloaded FiberTape® suture for the *InternalBrace™* technique, which peer-reviewed research associates with lower graft retear rates,² less pain, improved patient-reported outcomes, and a faster and higher rate of return to preinjury level of activity.³

The redesigned cortical button includes a proprietary knotless fifth locking mechanism for increased strength and resistance to cyclic displacement, allowing for precise, incremental retensioning of the construct after final fixation.⁴ Finally, the enhanced design of the packaging card improves suture management during implant assembly.

FiberTag TightRope II Implant

Product Description	Item Number
FiberTag TightRope II implant w/ FiberTape suture for the <i>InternalBrace</i> technique (a)	AR-1588RTT2-IB
FiberTag TightRope II implant (b)	AR-1588RTT2
FiberTag TightRope II ABS implant	AR-1588TNT2
GraftClamp graft preparation instrument	AR-2386T
FiberTag TightRope II implant w/ FlipCutter® III drill	AR-1288RTT2-FC3
FiberTag TightRope II implant w/ <i>InternalBrace</i> suture, ACL TightRope drill pin, and FiberLink™ suture	AR-1288RTT2-IBS
FiberTag TightRope II implant w/ <i>InternalBrace</i> suture, Flexible ACL TightRope drill pin, and FiberLink suture	AR-1288RTT2-IBSF

FiberTag TightRope I Implant Kits

Product Description	Item Number
ACL FiberTag TightRope implant system, 8-11 mm (kit includes: FiberTag TightRope RT implant and a QuadPro™ tendon harvester)	AR-1288QT-80 to 110
QuadLink™ implant system, 8-11 mm (kit includes: QuadPro harvester, FiberTag TightRope RT and ABS implants, 11 mm concave ABS button, a FlipCutter® III drill, FiberStick™ and TigerStick® sutures, FiberWire® and TigerWire® sutures, and a 12 mm × 3 mm PassPort Button™ cannula)	AR-1288QIS-80 to 110

References

- Arthrex, Inc. LA1-00038-EN_B. Naples, FL; 2017.
- Daniel AV, Wijdicks CA, Smith PA. Reduced incidence of revision anterior cruciate ligament reconstruction with internal brace augmentation. *Orthop J Sports Med.* 2023;11(7):23259671231178026. doi:10.1177/23259671231178026
- Bodendorfer BM, Michaelson EM, Shu HT, et al. Suture augmented versus standard anterior cruciate ligament reconstruction: a matched comparative analysis. *Arthroscopy.* 2019;35(7):2114-2122. doi:10.1016/j.arthro.2019.01.054
- Arthrex, Inc. Data on file (APT-G01155). Munich, Germany; 2020.

ACL TightRope® II RT Implant

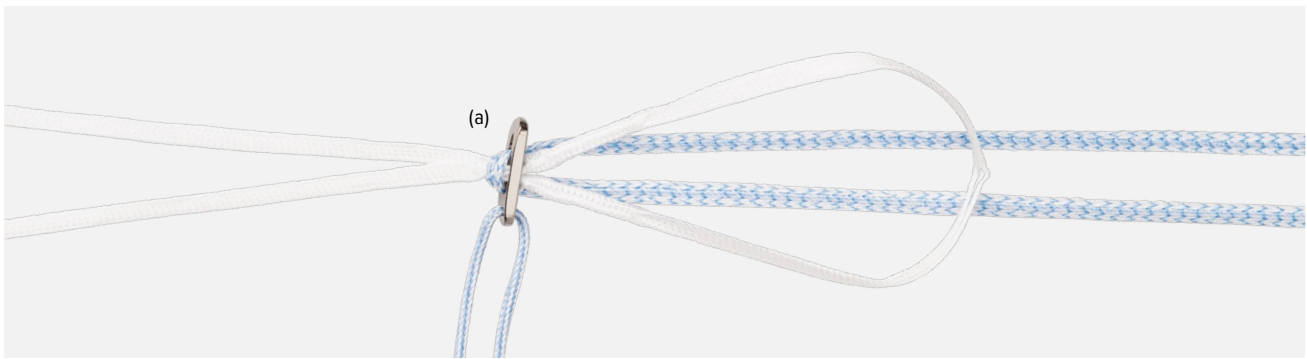

The new ACL TightRope II Implant is the first adjustable-loop cortical suspensory fixation implant to use a flat-tape design. The flat tape offers better handling characteristics and is more resistant to graft abrasion or tissue pull-through than traditional round sutures.¹

The redesigned cortical button now incorporates a proprietary 5-point locking design that resists cyclic displacement.² Engineered for precise graft tensioning, the adjustable-loop mechanism allows for incrementally retensioning of the graft construct after the implants have been secured on the cortex.

To accommodate various graft types and techniques, TightRope II implants are available in RT and BTB configurations loaded with an additional flipping suture or preloaded with FiberTape® suture for *Internal/Brace*™ technique. Available options for the ABS implant include standard or open.

TightRope II RT Implants

Product Description	Item Number
TightRope II RT implant w/ deploying suture	AR-1588RT-2J
TightRope II RT implant w/ FiberTape suture for the <i>Internal/Brace</i> technique (a)	AR-1588RT-IB
TightRope II RT implant w/ FiberTape suture for the <i>Internal/Brace</i> technique w/ FlipCutter® III drill	AR-1288RTIB-FC3
TightRope II RT implant system w/ 4 mm TightRope drill pin, #2 FiberLink suture, and 2 mm FiberTape suture for the <i>Internal/Brace</i> technique	AR-1588RT2-IBS
TightRope II RT implant system w/ flexible 4 mm TightRope drill pin, #2 FiberLink suture, and 2 mm FiberTape suture for the <i>Internal/Brace</i> technique	AR-1588RT2-IBSF
Autograft GraftLink implant system w/ FiberTape suture for the <i>Internal/Brace</i> technique	AR-1588AU-CP2

Reference

1. Arthrex, Inc. LA1-00038-EN_B. Naples, FL; 2017.
2. Arthrex, Inc. Data on file (APT-G01155). Munich, Germany; 2020.

GraftLink® Implant System

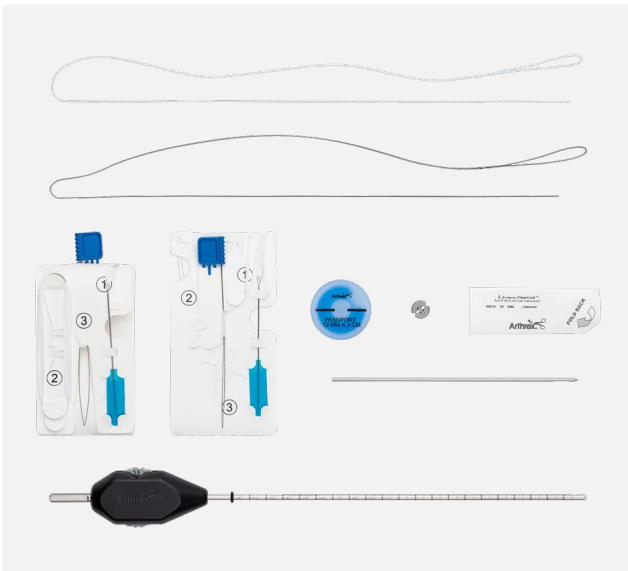
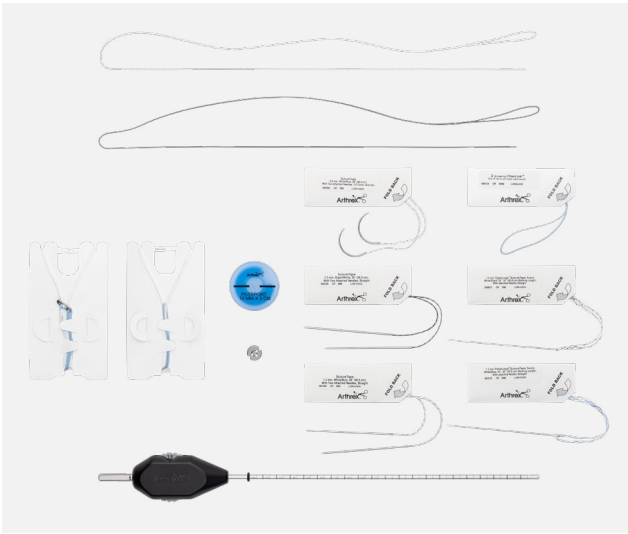

The comprehensive GraftLink implant systems optimize efficiency and streamline inventory by conveniently packaging all the implants and disposables required to perform a GraftLink procedure with the *Internal/Brace*™ technique.

Available for both autograft and allograft options, each implant system features the latest technology, including the TightRope II implant preloaded with FiberTape® suture for the *Internal/Brace* technique, TightRope® ABS 3-hole button, FlipCutter® III drill, FiberSnare® sutures, and new SutureTape options for optimized graft prep.

Autograft GraftLink® Implant System

Product Description	Item Number
Autograft GraftLink Implant System for the <i>Internal/Brace</i> Technique (a)	AR-1588AU-CP2
<ul style="list-style-type: none"> ■ TightRope® II RT implant w/ FiberTape® suture for the <i>Internal/Brace</i> technique ■ TightRope II ABS implant ■ TightRope ABS 3-hole button, 11 mm concave ■ FlipCutter® III drill ■ PassPort™ button cannula, 12 mm ID × 3 cm ■ #2 FiberSnare® suture, 26 in length w/ 2 in closed loop (white/blue) ■ #2 FiberSnare suture, 26 in length w/ 2 in closed loop (black/white) ■ 0.9 mm SutureTape 38 in, white/blue, w/ 2½, 36.6 mm curved tapered needles ■ 1.3 mm SutureTape 38 in, black/white, w/ 2 straight diamond-point needles, 64.8 mm ■ 1.3 mm SutureTape 38 in, white/blue, w/ 2 straight diamond-point needles 64.8 mm ■ #2 FiberLink™ suture w/ closed loop, 26 in (blue) ■ TigerLoop™ SutureTape, 1.3 mm, 20 in loop (white/black) w/ 76 mm straight needle ■ FiberLoop® SutureTape, 1.3 mm, 20 in loop (white/blue) w/ 76 mm straight needle 	

Allograft GraftLink Implant System

Product Description	Item Number
Allograft GraftLink Implant System for the <i>Internal/Brace</i> Technique (b)	AR-1588AL-CP2
<ul style="list-style-type: none"> ■ TightRope II BTB implant w/ FiberTape suture for the <i>Internal/Brace</i> technique ■ TightRope II ABS implant, open ■ TightRope ABS 3-hole button, 11 mm concave ■ FlipCutter III drill ■ PassPort button cannula, 12 mm ID × 3 cm ■ #2 FiberSnare suture, 26 in length w/ 2 in closed loop (white/blue) ■ #2 FiberSnare suture, 26 in length w/ 2 in closed loop (black/white) ■ #2 FiberLink suture w/ closed loop, 26 in (blue) ■ Guidewire w/ trocar tip, Ø.075 × 5.910 in 	

ACL TightRope® II BTB Implant

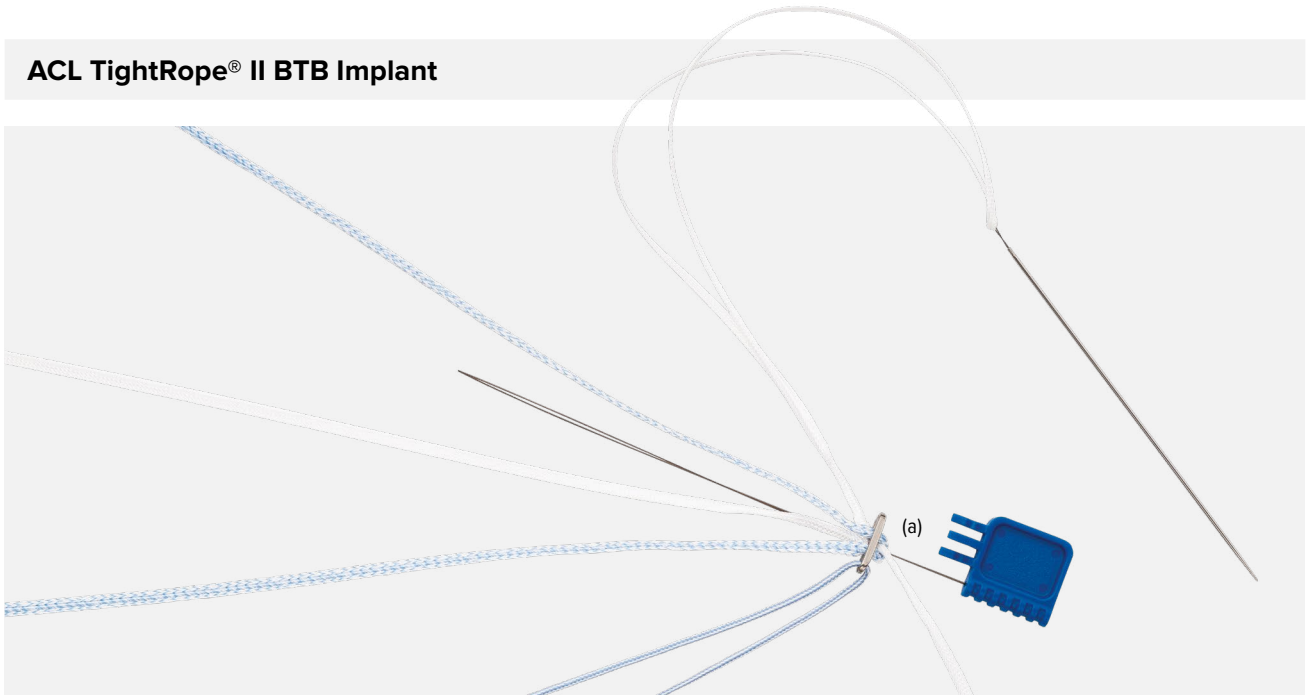

The bone-tendon-bone (BTB) TightRope II implant offers the same adjustable, 5-point locking system as the TightRope II RT implant, but the BTB implant can be placed through a small drill hole in the cortical bone block of the BTB, BQT, or Achilles graft. To improve the graft preparation process, the implant is loaded on a convenient and efficient assembly card, while the button facilitates dependable cortical fixation, and the adjustable SutureTape loop allows the graft to be pulled into the femoral socket as deeply as needed for ideal graft tunnel-matching. The BTB TightRope II implant also allows fixation of BTB/Achilles grafts into anatomic femoral sockets that can be difficult to reach with traditional interference screws.

TightRope II BTB Implants

Product Description	Item Number
TightRope II BTB implant w/ deploying suture	AR-1588BTB-2J
TightRope II BTB implant w/ FiberTape® suture for the <i>Internal/Brace</i> ™ technique (a)	AR-1588BTB-IB
TightRope II BTB implant, FiberTape suture for the <i>Internal/Brace</i> technique w/ FlipCutter® III drill	AR-1288BTBIB-FC3
TightRope II BTB-IB Implant System, w/ 4 mm TightRope drill pin, #2 FiberLink suture, and 2 mm FiberTape suture for the <i>Internal/Brace</i> technique	AR-1588BTB2-IBS
TightRope II BTB-IB Implant System, w/ flexible 4 mm TightRope drill pin, #2 FiberLink suture, and 2 mm FiberTape suture for the <i>Internal/Brace</i> technique	AR-1588BTB2-IBSF
Allograft GraftLink Implant System, for <i>Internal/Brace</i> technique	AR-1588AL-CP2

ACL TightRope® II ABS and ABS Buttons

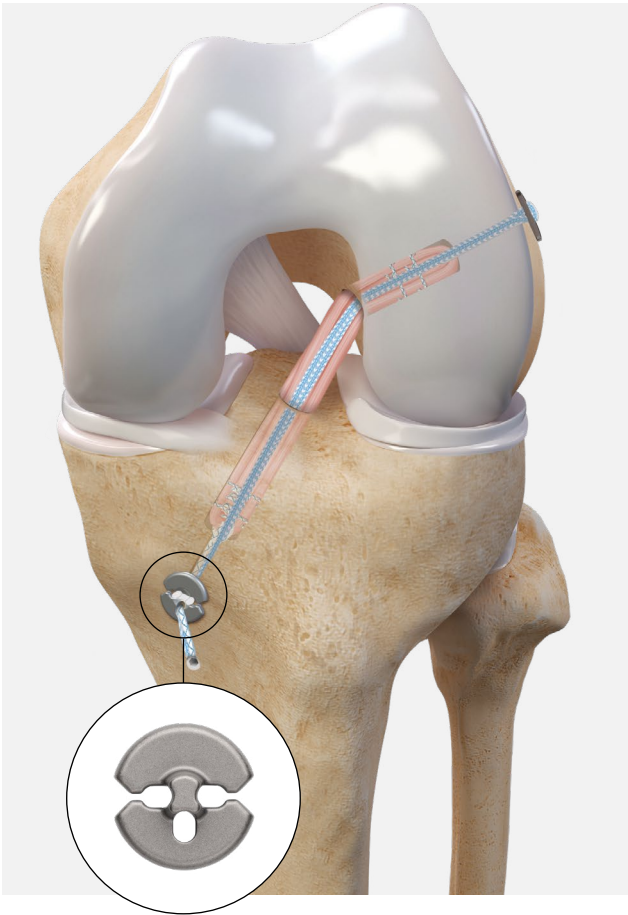

The unique TightRope ABS allows the ACL TightRope implant to be passed through a small bone tunnel without a button. Once passed through the tunnel, a large slotted button may be assembled to the TightRope implant. The concave ABS buttons provide a larger footprint for full tunnels from 4 mm through 13 mm. The center of the button is concave, which countersinks the suture, and it has a posterior collar to keep the button centered and stable in the tunnel.

TightRope II ABS Implants

Product Description	Item Number
TightRope II ABS implant	AR-1588TN-20
TightRope II ABS implant, open	AR-1588TN-21
FiberTag™ TightRope II ABS implant	AR-1588TNT2

TightRope ABS Buttons

Product Description	Item Number
TightRope ABS button, round, concave, 11 mm, for <i>Internal/Brace</i> technique	AR-1588TB-3IB
TightRope ABS button, round, concave, 14 mm	AR-1588TB-4
TightRope ABS button, round, concave, 17 mm	AR-1588TB-17
TightRope ABS button, round, concave, 20 mm	AR-1588TB-5
TightRope ABS button, 8 mm × 12 mm	AR-1588TB
TightRope ABS button, round, 14 mm	AR-1588TB-1
TightRope ABS button, oblong 3.4 mm × 13 mm	AR-1588TB-2

TightRope Button Extender

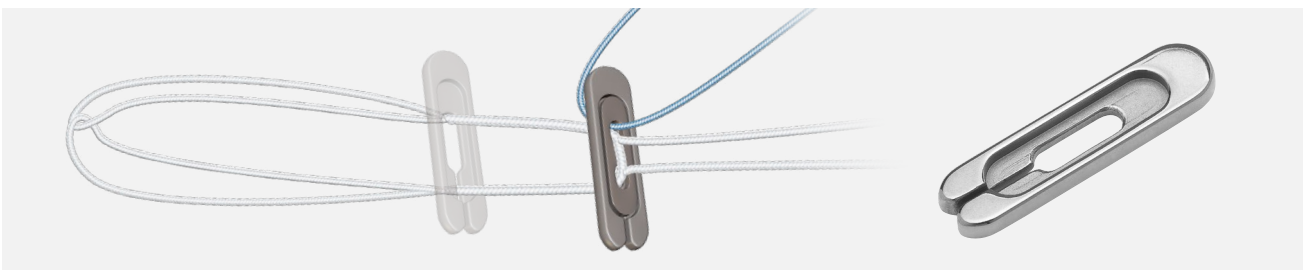

Ideal for cortical blowouts, revisions, and full tunnels, the TightRope button extender easily loads onto a TightRope button without removing the graft. A large 20 mm × 5 mm footprint maximizes button-to-bone contact against the cortex.

Product Description	Item Number
TightRope button extender	AR-1589RT

FastThread™ BioComposite Interference Screw

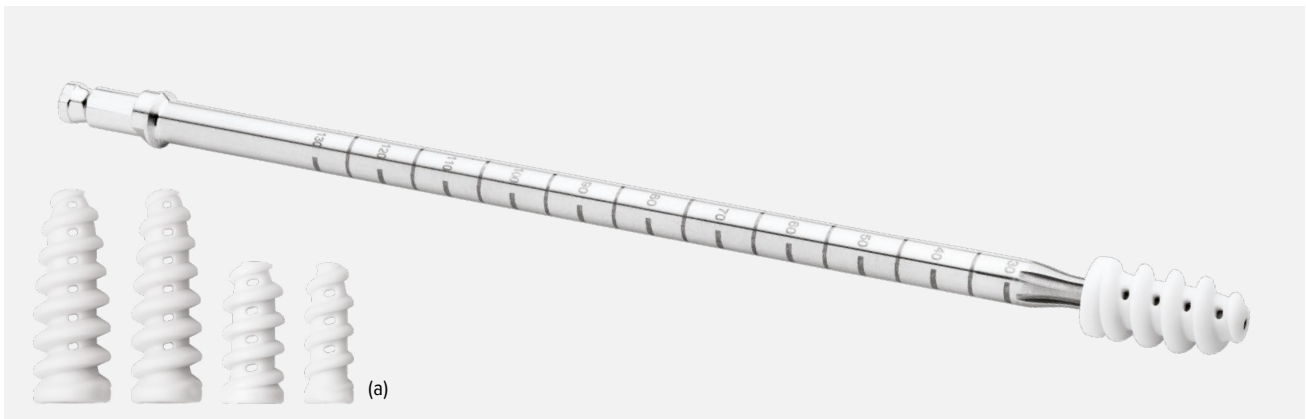

FastThread BioComposite interference screws feature a prominent leading and large thread pitch to facilitate screw engagement and advancement. Vented sidewalls and screw geometry decrease material by 22% without losing insertion or fixation strength.¹ The cannulation and fenestrations in the screw design allow for bony ingrowth and channeling of biologic growth factors during healing.¹

The screws, which come in 20 mm and 30 mm lengths, offer excellent strength on insertion and have been biomechanically tested.²

FastThread BioComposite Interference Screws

Product Description	Item Number
6 mm × 20 mm screws (used with 6 mm driver)	AR-4020C-06
7 mm-10 mm × 20 mm screws	AR-4020C-07 – 10
7 mm-12 mm × 30 mm screws (a)	AR-4030C-07 – 12

Drivers for 6 mm × 20 mm Screws

Product Description	Item Number
Fixed-handle driver	AR-4019SD
Quick-connect driver shaft	AR-4019D-1

Drivers for 7 mm-12 mm Screws

Product Description	Item Number
Fixed-handle driver for 20 mm and 30 mm screws	AR-19996SD
Quick-connect driver for 20 mm and 30 mm screws	AR-1996CD-1
Fixed-handle driver for 20 mm screws only	AR-4020SD
Quick-connect driver for 20 mm screws only	AR-4020D-1
Flexible-shaft quick-connect driver for 20 mm screws only	AR-4020DF
Nonratcheting screwdriver handle	AR-1999NR
Ratcheting screwdriver handle	AR-1999SD

Taps

Product Description	Item Number
Fixed-handle taps, 6-10 mm	AR-4020HT-06 – 10
Quick-connect tap shafts, 6-10 mm	AR-4020T-06 – 10
Flexible quick-connect tap shafts, 6-10 mm	AR-4020TF-06 – 10

References

1. Arthrex, Inc. LA1-00096-EN. Naples, FL; 2018.
2. Arthrex, Inc. LA1-00097-EN. Naples, FL; 2018.

FastThread™ PEEK Interference Screw

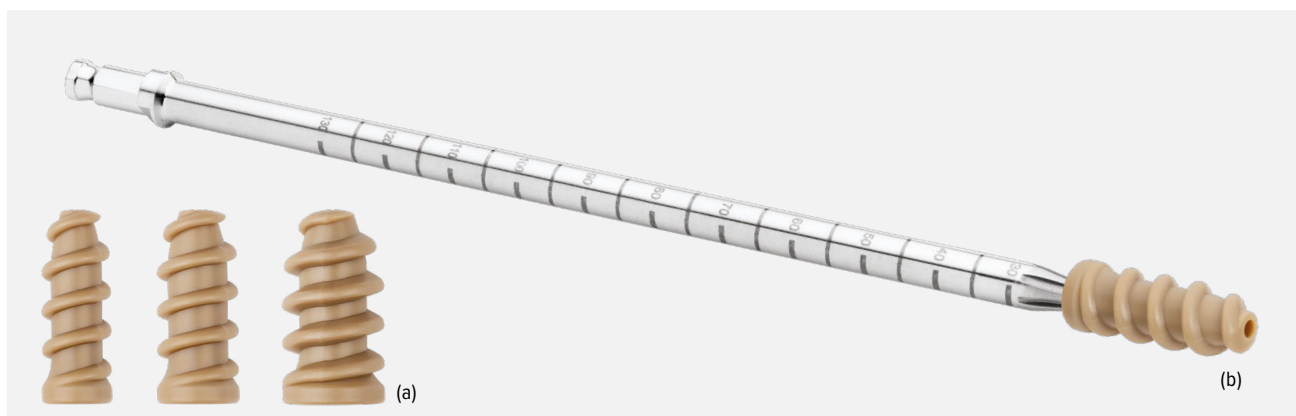

The PEEK family of FastThread interference screws allows for insertion similar to metal screws by eliminating the need to tap.

- **Faster insertion:** Prominent leading thread and large thread pitch facilitate screw engagement and advancement
- **Strength:** Optimized screw threads improve pullout strength compared to longer screws of the same diameter¹
- **Graft protection:** Thread design minimizes friction against the graft while the rounded end protects the graft at the aperture (20 mm screws are packaged with an insertion sheath)
- **PEEK-OPTIMA® material:** Affords advantages of metal screw insertion qualities but without visible hardware on imaging²

FastThread PEEK Interference Screws

Product Description	Item Number
6 mm × 20 mm screws (used with 6 mm driver)	AR-4020P-06
7-10 mm × 20 mm screws (a)	AR-4020P-07 – 10
7-12 mm × 30 mm screws	AR-4030P-07 – 12

Drivers for 6 mm × 20 mm Screws

Product Description	Item Number
Fixed-handle driver	AR-4019SD
Quick-connect driver shaft	AR-4019D-1

Drivers for 7 mm-12 mm Screws

Product Description	Item Number
Fixed-handle driver for 20 mm and 30 mm screws	AR-1996SD
Quick-connect driver for 20 mm and 30 mm screws	AR-1996CD-1
Fixed-handle driver for 20 mm screws only	AR-4020SD
Quick-connect driver for 20 mm screws only (b)	AR-4020D-1
Flexible-shaft quick-connect driver for 20 mm screws only	AR-4020DF
Nonratcheting screwdriver handle	AR-1999NR
Ratcheting screwdriver handle	AR-1999SD

Taps

Product Description	Item Number
Fixed-handle taps, 6 mm-10 mm	AR-4020HT-06 – 10
Quick-connect tap shafts, 6 mm-10 mm	AR-4020T-06 – 10
Flexible quick-connect tap shafts, 6 mm-10 mm	AR-4020TF-06 – 10

Screw Insertion Kit

Product Description	Item Number
Interference Screw Insertion Kit w/ dilator and 1.1 mm trocar-tip guidewire	AR-1249TK
Trocar-tip guidewire, 1.1 mm, w/o dilator	AR-1249T

References

1. Arthrex, Inc. LA1-00099-EN_A. Naples, FL; 2018.
2. Wilde J, Bedi A, Altchek DW. Revision anterior cruciate ligament reconstruction. *Sports Health*. 2014;6(6):504-518. doi:10.1177/1941738113500910

GraftBolt® Implant



The GraftBolt implant is designed for tibial fixation of soft-tissue grafts during cruciate ligament reconstruction procedures. The PEEK implant consists of a sheath and mating screw, packaged together. Both are fully cannulated. The GraftBolt instrument set includes dilators and sheath insertion and removal tools as well as a hexalobe driver for screw insertion.

GraftBolt Implants

Product Description	Item Number
GraftBolt sheath w/ screw, 7 mm	AR-5100-07
GraftBolt sheath w/ Screw, 8 mm	AR-5100-08
GraftBolt sheath w/ screw, 9 mm	AR-5100-09
GraftBolt sheath w/ screw, 10 mm	AR-5100-10

Transtibial Fixation Device Instrument Set (AR-5100S)

Product Description	Item Number
Quick-connect T-handle	AR-1416T
GraftBolt removal tool	AR-5102
GraftBolt inserter, 7 mm	AR-5103
GraftBolt inserter, 8-9 mm	AR-5104
GraftBolt inserter, 10 mm	AR-5101
GraftBolt dilator, 6 mm	AR-5106
GraftBolt dilator, 7 mm	AR-5107
GraftBolt dilator, 8 mm	AR-5108
GraftBolt dilator, 9 mm	AR-5109
GraftBolt dilator, 10 mm	AR-5110
Graft spreader	AR-1842
Ratcheting screwdriver handle	AR-1999
Hexalobe driver shaft	AR-1996CD-1
GraftBolt instrument case	AR-5100C

Implants

Product Description	Item Number
Suture tensioner w/ tensiometer	AR-1529
Foot for suture tensioner	AR-1530

Suture Buttons



Two- and four-hole titanium suture buttons are ideal for primary or backup FiberWire® fixation of ACL/ PCL grafts and augmenting bone bridges. Suture buttons come sterile and ready for use.

Product Description	Item Number
Suture button, 3.5 mm and 12 mm, round	AR-8920 and AR-8922
Suture button inserter	AR-8923

RetroButton® XL Implant

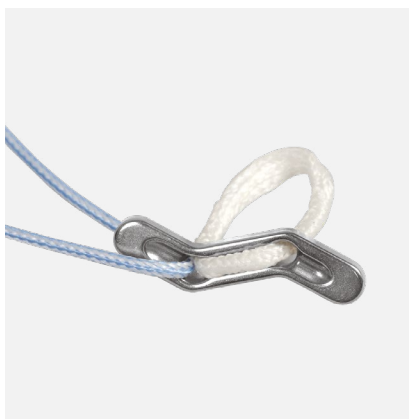

The RetroButton XL implant's unique button provides better coverage over cortical bone while minimizing the distance the button must travel past the cortex to flip. The "Z"-shaped button covers 20 mm of bone with only 18 mm of overall length. This facilitates flipping and decreases the chance of catching soft tissue under the button. The short 11 mm loop allows the graft to be positioned directly under the button, maximizing soft-tissue fill in short tunnels. Use the RetroButton XL implant when the femoral cortex is inadvertently damaged during drilling, for revision ACLR, or when the femoral condyle is too small for a socket.

Product Description	Item Number
RetroButton XL implant, 20 mm long, 11 mm loop	AR-1592

RetroButton® Implant



The RetroButton implant is the fastest way to obtain strong suture-button fixation on cortical bone. The 12 mm and 15 mm long titanium buttons pass through a small cortical pinhole without overdrilling. The GraftPro® button holder attachment allows graft tensioning with the RetroButton implant in place and confirms proper loop length.

Product Description	Item Number
RetroButton implants, 12 mm, 15-30 mm loop	AR-1588-15 – AR-1588-30
RetroButton drill pin II	AR-1595
RetroButton drill pin, 3 mm	AR-1590
RetroButton depth guide	AR-1270
GraftPro button holder	AR-2950BH

ACL Backup Fixation Kits



ACL SwiveLock® BioComposite Fixation Kit

Product Description	Item Number
ACL SwiveLock BioComposite Fixation Kit	AR-1593-BC



ACL SwiveLock PEEK Fixation Kit

Product Description	Item Number
ACL SwiveLock PEEK Fixation Kit	AR-1593-P

The ACL Backup Fixation System includes implants and instruments that support backup fixation of ACL graft sutures and FiberTape® suture for *InternalBrace™* technique for ACL reconstructions and primary repairs. The kit contains a 4.75 mm SwiveLock implant as well as a spade-tipped drill and disposable tap. This system provides a reliable and reproducible augment to ACL tibial fixation.

ACL/PCL Cortical Fixation Set

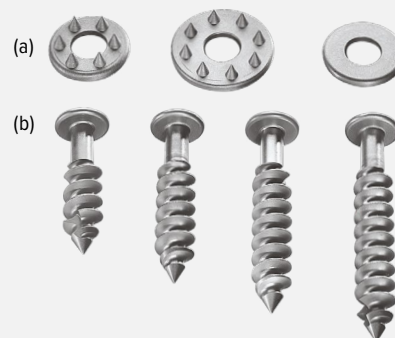
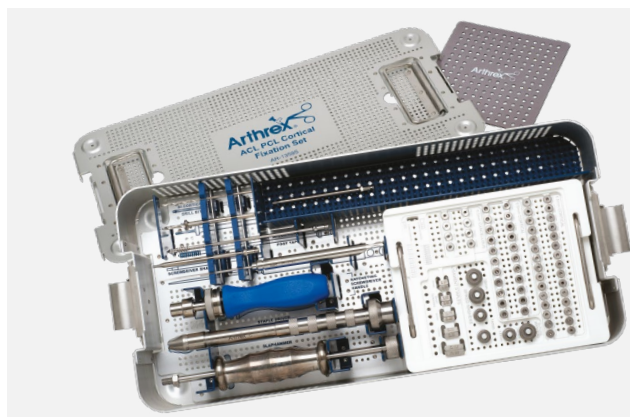

The ACL/PCL Cortical Fixation Set combines low-profile instruments from the bicortical post set (AR-1365S), the ligament staple driver set (AR-1005S), and the cancellous screw and washer set (AR-1359). The set also includes an implant caddy to hold the screws, washers, and staples (sold separately).

The system includes the 4.5 mm- and 6.5 mm-diameter bicortical post and 6.5 mm cancellous screws. Low-profile spiked and unspiked washers as well as ligament staples are also included.

ACL/PCL Cortical Fixation Set (AR-1359S)

Product Description	Item Number
Staple driver	AR-1005
Replacement jaw set for staple driver	AR-1005-01
Slap hammer/extractor	AR-1005H
Drill, cancellous screw, 25 mm length	AR-1355D
Drill for bicortical post	AR-1365D
Tap for bicortical post	AR-1365T
Bicortical post tap, 6.5 mm	AR-1366T
Bicortical Bio-Post® fixation drill bit	AR-1367D
Short screwdriver shaft, 2.5 mm hex, noncannulated	AR-1995SHN
Short screwdriver shaft, 3.5 mm hex, cannulated	AR-1998SH
Ratcheting screwdriver handle	AR-1999
Depth device, large	AR-4167
Instrumentation case	AR-1359C

Bicortical posts, 4.5 mm × 25-60 mm, sterile (2.5 mm increments)	AR-1365-25 – 60
Bicortical posts, 4.5 mm × 25-60 mm, nonsterile (2.5 mm increments)	AR-1365NS-25 – 60
Bicortical posts, 6.5 mm × 30-50 mm, sterile (2 mm increments)	AR-1366-30 – 50
Bicortical posts, 6.5 mm × 30-50 mm, nonsterile (2 mm increments)	AR-1366NS-30 – 50
Spiked washers for cancellous screws, 14 mm and 18 mm, sterile (a)	AR-1349 and AR-1349L
Spiked washers for cancellous screws, 14 mm and 18 mm, nonsterile	AR-1349NS and AR-1349LNS
Suture washers for cancellous screws, 14 mm and 18 mm, sterile (a)	AR-1349M and AR-1349LM
Suture washers for cancellous screws, 14 mm and 18 mm, nonsterile	AR-1349MNS and AR-1349LMNS
Spiked ligament staple, 6 mm width, sterile	AR-1006
Spiked ligament staple, 6 mm width, nonsterile	AR-1006NS
Spikeless ligament staple, 6 mm width, sterile	AR-1006M
Spikeless ligament staple, 6 mm width, nonsterile	AR-1006MNS
Spiked ligament staple, 8 mm width, sterile	AR-1008
Spiked ligament staple, 11 mm width, sterile	AR-1011
Spiked ligament staple, 16 mm width, sterile	AR-1016
Spiked ligament staple, 8 mm width, nonsterile	AR-1008NS
Spiked ligament staple, 11 mm width, nonsterile	AR-1011NS
Spiked ligament staple, 16 mm width, nonsterile	AR-1016NS
Low-profile cancellous screw, 6.5 mm × 25-40 mm, sterile (5 mm increments) (b)	AR-1355 – AR-1358
Low-profile cancellous screw, 6.5 mm × 25-40 mm, nonsterile (5 mm increments)	AR-1355NS – AR-1358NS

Screw Insertion and Removal

- SlapDriver Interference Screwdriver 64
- Tunnel Notchers..... 64
- Interference Screw Insertion Kit..... 65
- FastThread™ Interference Screw Instrument Set..... 65

SlapDriver Interference Screwdriver



The SlapDriver interference screwdriver family was designed to combine the technology and reliability of our hexalobe, trilobe, and quick connect ratcheting screwdrivers with the convenience of a built-in slap-hammer mechanism to make driver removal easier and faster.

SlapDrivers

Product Description	Item Number
SlapDriver, ratcheting quick connect handle	AR-1999SD
SlapDriver, fixed, for 20 mm and 30 mm lengths only (hexalobe)	AR-1996SD
SlapDriver, fixed, for 6 mm-diameter screws only (trilobe)	AR-4019SD
SlapDriver, fixed, for 20 mm-length screws only (hexalobe)	AR-4020SD

Quick Connect Driver

Product Description	Item Number
Quick-connect driver, for 20 mm and 30 mm screws (hexalobe)	AR-1996CD-1
Quick-connect driver, for 20 mm-length screws only (hexalobe)	AR-4020D-1
Quick-connect driver, extended-length shaft (hexalobe)	AR-1996CDL-1
Flexible quick-connect driver, for 20 mm-length screws only (hexalobe)	AR-4020DF
Quick-connect driver, for 6 mm-diameter screws only (trilobe)	AR-4019D-1

Tunnel Notchers

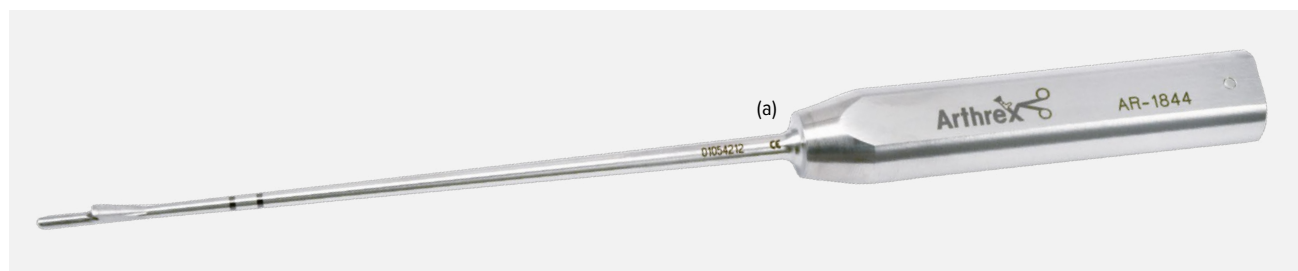

The tunnel notcher creates a perfectly sized “keyhole” in the anterior wall of the femoral tunnel to facilitate guide pin and interference screw insertion. The wider tunnel notcher for the bio-interference screw creates a broader “keyhole” in the anterior wall of the femoral tunnel to facilitate insertion of a bio-interference screw.

Product Description	Item Number
Tunnel notcher (a)	AR-1844
Tunnel notcher for bio-interference screw	AR-1845
RetroScrew® tunnel notcher	AR-1843BT

Interference Screw Insertion Kit



The Interference Screw Insertion Kit was developed to improve screw trajectory and stability. This new tunnel-notching system is offered as a disposable kit for convenience and reliability during anterior cruciate ligament (ACL) reconstruction.

Interference Screw Insertion Kit, w/ dilator and 1.1 mm trocar-tip guidewire (AR-1249TK)

Product Description	Item Number
Trocar-tip guidewire, 1.1 mm, w/ dilator	AR-1249T

FastThread™ Interference Screw Instrument Set

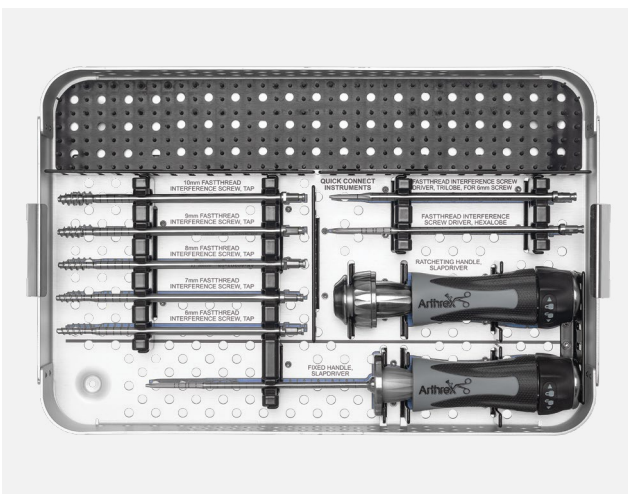

FastThread Interference Screw Instrumentation Set (AR-1996S)

Product Description	Item Number
SlapDriver, ratcheting quick connect handle	AR-1999SD
SlapDriver, fixed, for 20 mm and 30 mm lengths only (hexalobe)	AR-1996SD
Quick-connect driver, for 20 mm and 30 mm screws (hexalobe)	AR-1996CD-1
FastThread interference screw driver, 6 mm	AR-4019D-1
FastThread interference screw tap, 6 mm	AR-4020T-06
FastThread interference screw tap, 7 mm	AR-4020T-07
FastThread interference screw tap, 8 mm	AR-4020T-08
FastThread interference screw tap, 9 mm	AR-4020T-09
FastThread interference screw tap, 10 mm	AR-4020T-10
FastThread interference screw case	AR-1996C

PCL Reconstruction

PCL ToolBox Instrumentation Set.....	68
Knee Obturator for Posterior Portal.....	69
PCL Suture Passer.....	69
Double-Bundle PCL Technique.....	70

PCL ToolBox Instrumentation Set



The PCL ToolBox addresses most modern PCL reconstruction techniques. The streamlined case includes the side-release RetroConstruction™ handle, marking hooks and drill sleeves for FlipCutter® and RetroDrill® reamers, and standard 2.4 mm guide pins. Additionally, the set also includes all additional instruments needed for the procedure. The first level of the tray holds the RetroConstruction handle, drill sleeves, drill sleeve inserts, parallel guides, and probe; femoral and tibial PCL marking hooks are also accessible from the first level. In addition to the standard femoral and tibial PCL marking hooks, the kit includes the new anatomic contour PCL tibial guides. The top level has an open pin mat area for adding other items specific to surgeons' preferences. The middle level holds curettes, rasps, a suture pusher, a popliteal protector cap, a knee obturator, tunnel plugs, an obturator for the cannulated tunnel plug, and a graft sizing block. The bottom tray holds the double-bundle PCL guides, drills, reamers, a ratcheting screwdriver handle, 3 screwdriver shafts, a Jacob's chuck handle, and a chuck key.

PCL Cruciate Reconstruction ToolBox Set (AR-1269S)

Product Description	Item Number
Hook probe, 3.4 mm	AR-10010
Side-release RetroConstruction handle	AR-1510HR
Ratchet drill sleeve, 2.4 mm	AR-1510FD-24
Stepped, ratchet drill sleeve, 7 mm step	AR-1510FS-7
Stepped, ratchet drill sleeve, 10 mm step	AR-1204FDS-10
Obturator, 3.5 mm	AR-1204F-OB
Insert, 2.4 mm	AR-1204F-24i
Cannulated drill, 9 mm	AR-1209L
Cannulated drill, 10 mm	AR-1214L
Cannulated drill, 11 mm	AR-1217L
Parallel guide sleeve, 2.4 mm pins	AR-1245L
Offset drill guide, 3.5 mm	AR-1246-1
Offset drill guide, 3.5 mm pins	AR-1246-3
Tunnel plug	AR-1258
PCL suture pusher	AR-1263
PCL rasp	AR-1264
Knee obturator for posterior portal	AR-1266
PCL popliteal protector cap	AR-1267
Cannulated headed reamers, 8-11 mm	AR-1408 – AR-1411
Jacob's chuck handle	AR-1415
Anatomic contour PCL guide, left	AR-1510PTL
Anatomic contour PCL guide, right	AR-1510PTR
Tibial PCL marking hook for RetroConstruction drill guide	AR-1510PT
Femoral PCL marking hook for RetroConstruction drill guide	AR-1510PF
Obturator for AR-1802D	AR-1807
Tunnel notcher	AR-1845
Graft sizing block	AR-1886
BioComposite driver, quick connect	AR-1996CD-1
Cannulated screwdriver shaft for delta bio-interference screw	AR-1997D
Cannulated screwdriver shaft, 3.5 mm hex	AR-1998
SlapDriver, ratcheting quick-connect handle	AR-1999SD
Double bundle PCL guides, 6-11 mm	AR-5015-06 – 11
PCL curved curette, closed end	AR-5013
PCL straight curette, closed end	AR-5014
Chuck key	AR-8241
PCL Cruciate ToolBox instrumentation case	AR-1269C

Knee Obturator for Posterior Portal



The knee obturator was specially designed to simplify the location and creation of posterior knee portals as well as the introduction of a cannula. Posterior portals are often necessary for several common procedures, such as loose body removal, PCL reconstruction, meniscal root avulsion repair, and popliteal cyst debridement. Current outside-in techniques can be time-consuming and put posterior structures at risk of damage with sharp spinal needles and scalpels.

The knee obturator lets surgeons quickly create the portal from the inside-out. The unique curvature fits around the cruciate ligaments and around the back of the femoral condyles. The tapered eyelet tip facilitates insertion of a PassPort Button™ cannula with a traction suture or it acts as a switching stick for cannula insertion.

Product Description	Item Number
Knee obturator for posterior portal	AR-1266

PCL Suture Passer



The PCL curving suture passer is designed to carry graft-passing sutures through the tibial tunnel into the intercondylar notch. As the wire loop and suture exit the tube, the wire curves into the notch for easy viewing and suture retrieval through the femoral tunnel. Place a graft-passing suture no more than 1 inch through the wire loop and pull both the suture and loop into the tube.

After passing the tube through the tibial tunnel, advance the wire loop with suture, transporting the suture loop into the notch. Retrieve the suture from the wire loop with

a grasper from an anterior portal to retract and remove the suture passer. Insert a grasper that is compatible with full tibial tunnels and FlipCutter® sockets, then pass the suture through the femoral tunnel.

Product Description	Item Number
Curving suture passer, disposable	AR-1268D

Double-Bundle PCL Technique



The double-bundle PCL guides were developed to create accurate and reproducible femoral tunnels, which are necessary in arthroscopic double-bundle PCL reconstructions. The guides simplify guide pin placement for anterolateral and posteromedial femoral tunnel sockets drilled endoscopically from an anterolateral portal.

During anterolateral tunnel placement, a guide can be used either to reference and offset the tunnel 2 mm from the articular cartilage margin or as a visual aid that simulates exact tunnel position and size. The guides will mimic the subsequent drill hole and, therefore, make exact tunnel placement possible.

Double-Bundle PCL Set (AR-5015SS)

Product Description	Item Number
Double-bundle PCL guides, 6-12 mm	AR-5015-06 – 12
Double-bundle PCL guide instrument case	AR-5015C

Collateral Ligament Reconstruction and Repair

Knee FiberTak® Anchors	74
Collateral Ligament Reconstruction Set	76
Medial Collateral Ligament (MCL) <i>InternalBrace</i> ™ Procedure Kit.....	77
Anterolateral Ligament Reconstruction Set.....	78
Collateral Ligament Reconstruction With FiberTag® TightRope® Implants	79

Knee FiberTak® Anchors

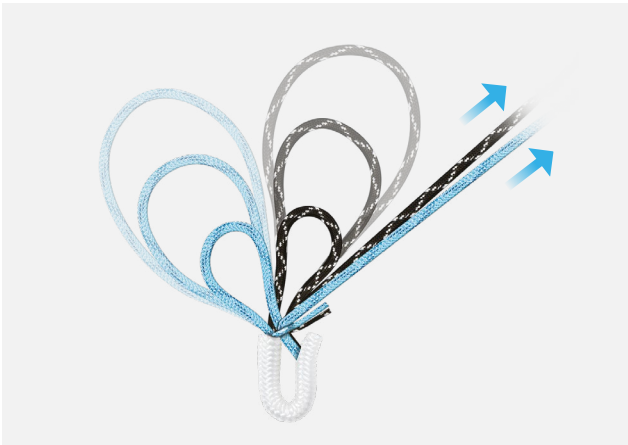

Knee FiberTak anchors are the first suture anchors that use SutureTape in a tensionable knotless mechanism, combining the benefits of SutureTape with retensionability. The SutureTapes feature vibrant new blue-and-black braid designs that make suture identification and management easier in an open surgical environment. For additional efficiency, the knotless implants feature preconverted tensionable loops, eliminating the need to shuttle the repair suture through the splice. Disposable and reusable, the instrumentation was ergonomically designed with a short working length to allow the surgeon to get close to the anatomy. The surgeon can prep a pilot hole using a calibrated drill, an awl, or even a self-punch in appropriate bone density.



Knee FiberTak Anchors

Product Description	Item Number
Double Knotless Knee FiberTak anchor	AR-3740SP
Hybrid Knotless Knee FiberTak anchor	AR-3770SP
Double Knotted Knee FiberTak anchor	AR-3730SP
Knee FiberTak button	AR-3780SP
Knee FiberTak anchor for the <i>InternalBrace</i> ™ technique (a)	AR-3750

Instrumentation

Product Description	Item Number
Disposable guide	AR-3710
2.6 mm drill (sold in a kit or separately)	AR-3712
Reusable punch	AR-3714
Reusable guide	AR-3711



Anchor Platform

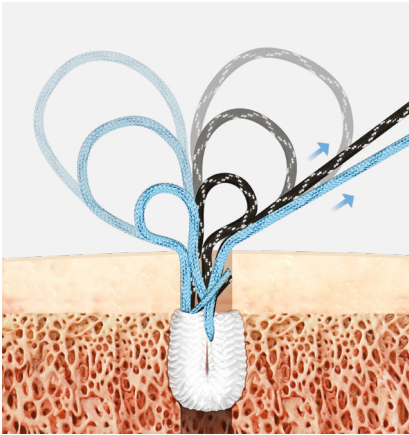

Double Knotless Knee FiberTak® Anchor | Features: 2 preconverted knotless tensionable 1.3 mm SutureTape loops (a great option for LET and ALL fixation)

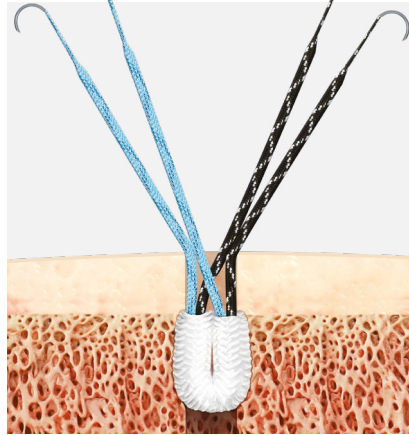

Double Knotted Knee FiberTak Anchor | Features: 2 sliding 1.3 mm SutureTapes with swaged-on needles (a great option for any application that requires knots)

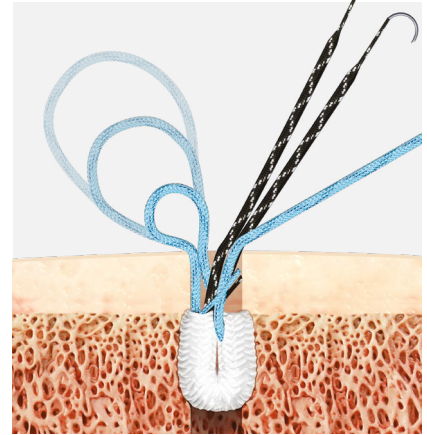

Hybrid Anchor Knee FiberTak Anchor | Features: 1 preconverted tensionable knotless SutureTape loop and a sliding 1.3 mm SutureTape with swaged-on needles (perfect for onlay MPFL reconstruction)

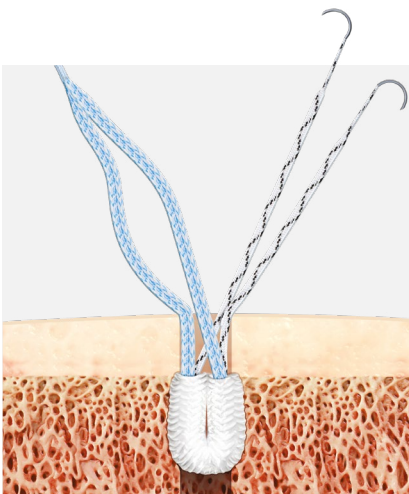

Knee FiberTak Anchor for the InternalBrace™
Technique | Features: 1 sliding 1.3 mm SutureTape with swaged-on needles and a low-profile 1.7 mm FiberTape® loop swaged to a single tail for easy passage and loading (revolutionary for collateral repair using the *InternalBrace* technique)

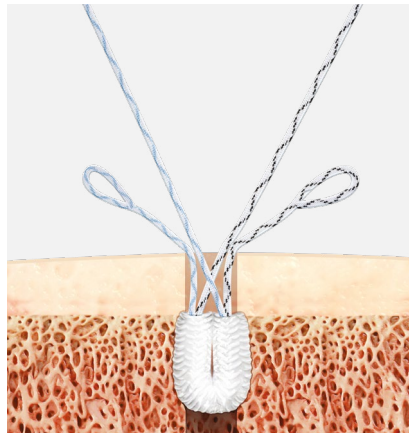

Knee FiberTak Button | Features: 2 passing links for fixation of independent tension-slide constructs (an excellent option for MCL and LCL tension slide)

Collateral Ligament Reconstruction Set



The Collateral Ligament Reconstruction Set allows for precision-based, biomechanically validated anatomic reconstructions of individual components and main structures of the posterolateral and medial knee. For minimally invasive and open techniques performed during fibular-based reconstructions, use the unique fibular marking hook, which tightly contours the fibular head and enables surgeons to get around anatomic structures while placing the 8 mm-diameter paddle. This marking hook was designed specifically to fit onto the fibular attachment of the popliteofibular ligament (PFL).

The tibial marking hook was designed for posterolateral and medial/posteromedial tibia-based reconstructions. The ergonomic, 8 mm-diameter paddle provides tactile feedback upon entry into the posterior popliteal sulcus and confirms the zebra guide pin's exit point during posterolateral corner reconstructions.

Increase the efficiency of anatomic tunnel drilling using the parallel drill guide, which reduces divergent tunnels and allows precision placement at multiple incremental distances for medial and lateral femoral-based reconstructions.

Collateral Ligament Reconstruction Set (AR-5500S)

Product Description	Item Number
Collateral Ligament Reconstruction Set	AR-5500S
Fibular marking hook	AR-5500
Tibial collateral marking hook	AR-5501
Femoral collateral marking hook	AR-5502
Parallel drill guide	AR-5503
Collateral ligament retractor	AR-5504
Collateral ligament rasp	AR-5506
Graft sizing block	AR-1886
RetroConstruction™ side release drill guide handle	AR-1510HR

10 mm RetroConstruction drill sleeve drill guide, stepped, long tip	AR-1204FDS-10
2.4 mm ratcheting drill sleeve	AR-1510FD-24
2.4 mm zebra pin for isometry testing	AR-1250Z
GraftClamp graft preparation instrument	AR-2386T
6 mm cannulated drill	AR-1206L
7 mm cannulated drill	AR-1207L
8 mm cannulated drill	AR-1208L
9 mm cannulated drill	AR-1209L
10 mm cannulated drill	AR-1214L

Accessories

Product Description	Item Number
Zebra Guide Pin, 2.4 mm, open eyelet	AR-1250Z
ACL TightRope® drill pin II, 4 mm, open eyelet	AR-1595T
Tunnel notcher for bio-interference screw	AR-1845
#2 FiberLoop® suture w/ straight needle	AR-7234
#2 FiberStick™ suture, 50 in (blue), one end stiffened, 12 in	AR-7209

Implants

Product Description	Item Number
FiberTag® TightRope II implant	AR-1588RTT2
FiberTag TightRope II ABS implant	AR-1588TNT2
TightRope II RT implant w/ deploying suture	AR-1588RT-2J
TightRope II RT implant w/ FiberTape® suture for the <i>Internal/Brace</i> ™ technique	AR-1588RT-IB
ACL BioComposite SwiveLock® fixation kit	AR-1593-BC
ACL PEEK SwiveLock fixation kit	AR-1593-P
TightRope II ABS implant	AR-1588TN-20
TightRope II ABS implant, open	AR-1588TN-21
TightRope ABS button, round, concave, 11 mm	AR-1588TB-3

FastThread™ BioComposite Interference Screws

Product Description	Item Number
6 mm × 20 mm screws (used with 6 mm driver)	AR-4020C-06
7-10 mm × 20 mm screws	AR-4020C-07 – 10
7-12 mm × 30 mm screws	AR-4030C-07 – 12

Literature

Brochure	Reference Number
Collateral Ligament Brochure	LB1-0127-EN

Medial Collateral Ligament (MCL) *Internal/Brace*™ Procedure Kit



MCL *Internal/Brace* technique is comprised of SwiveLock® anchors and FiberTape® suture, which are intended for fixation of soft tissue to bone and for approximation of soft tissue. FiberTape sutures have been used for 10 years in more than 1.5 million tendon or ligament-bridging repairs.¹

Product Description	Item Number
MCL Repair Kit	AR-5511-CP
<ul style="list-style-type: none"> ■ BioComposite SwiveLock anchor, 4.75 mm × 15 mm, qty. 2 ■ Shoehorn cannula ■ Cannulated drill bit, 4.5 mm ■ Guide pins, 2.4 mm × 8 in, qty. 2 ■ SwiveLock punch/Tap, 4.75 mm, disposable ■ FiberTape suture, 17 in ■ #2 FiberWire® suture, qty. 2 	

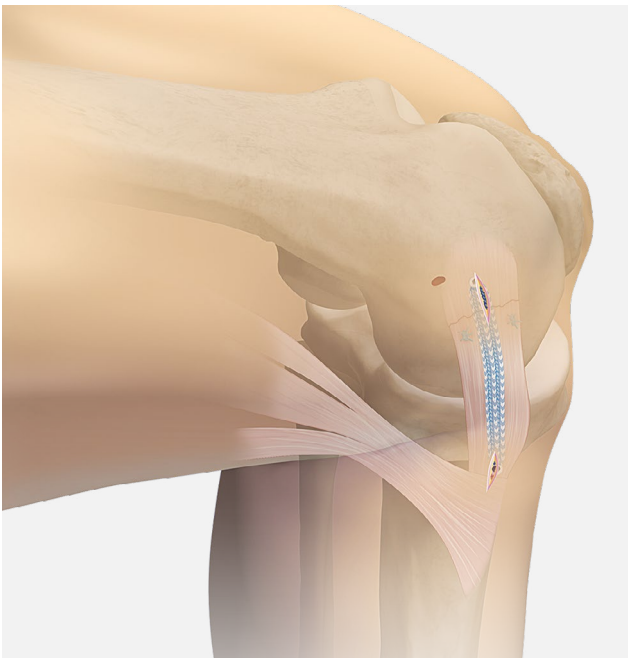

Reference

1. Arthrex, Inc. LA1-0237-EN. Naples, FL; 2009.

Anterolateral Ligament Reconstruction Set



Anterolateral ligament reconstruction is aimed at augmenting rotational stability in the ACL-reconstructed knee. Because combined injuries to both the ACL and ALL or deep iliotibial (IT) band act as a prerequisite for the occurrence of an IKDC grade III pivot-shift, ACL-injured patients with a high-grade pivot-shift might benefit from an additional anterolateral reconstruction in order to avoid persistent rotational laxity. Hyperlax females with excessive recurvatum and physiologic joint laxity are potentially appropriate candidates for combined ACL reconstruction and extra-articular stabilization.¹ Furthermore, in ACL-injured pivoting athletes who require absolute stability, anterolateral reconstruction should be contemplated if only an IKDC grade II pivot-shift is present.

Finally, revision ACL reconstruction cases commonly exhibit significant rotational laxity due to a tendency for increased joint laxity from previous meniscus removal or resultant laxity of secondary ligamentous restraints. Especially in the absence of frank re-trauma or obvious technical errors that explain graft failure, concomitant ALL reconstruction should always be considered as a means of improving stability in these complex cases. The technique can be performed with a single-strand graft and two points of fixation or as a two-stranded construct using a transosseous tunnel on the tibia.

Anterolateral Ligament Reconstruction Kit (AR-5522)

Product Description	Item Number
Implants	
BioComposite SwiveLock® C anchor, 4.75 mm × 19.1 mm, vented w/ closed eyelet	AR-2324BCC
PEEK SwiveLock tenodesis anchor, 7 mm × 19.5 mm	AR-1662PSL-7
Disposables	
#2 FiberWire® suture	AR-7233
#2 FiberLoop® suture w/ straight needle (blue)	AR-7234
#2 TigerLoop™ suture w/ straight needle, w/ TigerWire® suture	AR-7234T
Drill pin, 2.4 mm	AR-1250L
Cannulated drill, 4.5 mm	AR-1204.5L
Cannulated drill, 7 mm	AR-1207L

Reference

- Jesani S, Getgood A. Modified Lemaire lateral extra-articular tenodesis augmentation of anterior cruciate ligament reconstruction. *JBJS Essent Surg Tech*. 2019;9(4):e41.1-7. doi:10.2106/JBJS.ST.19.00017

Collateral Ligament Reconstruction With FiberTag® TightRope® Implants

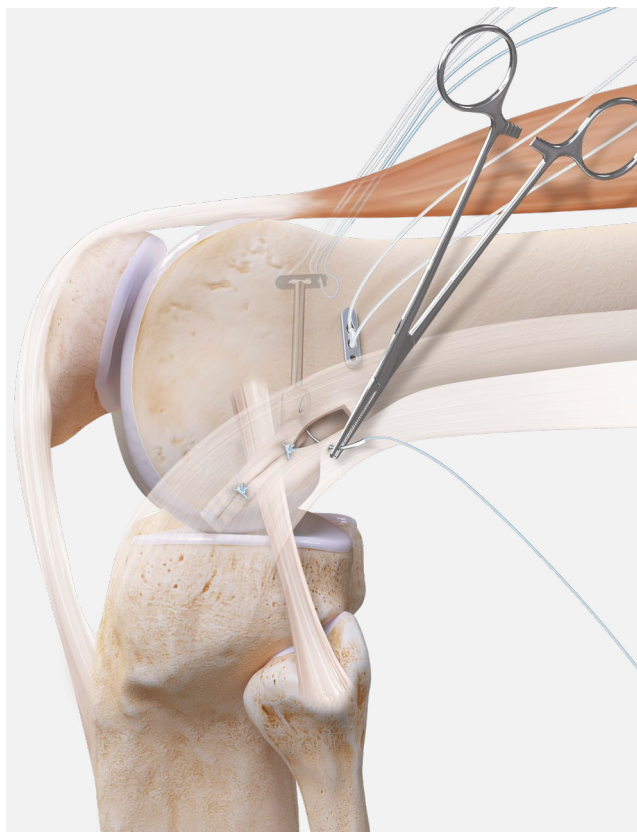

The FiberTag TightRope implant facilitates the attachment of single-stranded grafts to an ACL TightRope implant. FiberTag suture is integrated into the TightRope implant for a strong, consistent connection between the suture and TightRope loop. A simplified suturing technique, along with an innovative suture management card and the new GraftClamp graft preparation instrument, make preparing single-stranded grafts faster and more reproducible than ever.

The FiberTag TightRope implant offers several distinct advantages when compared to other fixation devices:

- Allows for precise, incremental tensioning of the graft
- Minimizes the length and size of the graft required
- Allows for smaller socket size to reduce chance of tunnel convergence with an ACL tunnel
- Allows for circumferential healing of the graft within the socket
- Cortical fixation eliminates the risk of graft laceration from an interference screw

Product Description	Item Number
MPFL TightRope implant, w/ straight needle	AR-1588PF
MPFL TightRope implant, w/ curved needle	AAR-1588PFC
Collateral TightRope implant, w/ curved needle	AR-1588CL
Collateral TightRope implant, w/ straight needle	AR-1588CLS
4 mm ACL TightRope drill pin, open eyelet	AR-1595T
6 mm low-profile reamer, sterile	AR-1406LP
GraftClamp graft preparation instrument	AR-2386T

Literature

Surgical Technique Guide	Reference Number
Iliotibial Band Tenodesis w/ FiberTag TightRope implant	LT1-000185-en-US

Patellofemoral Procedures

Medial Patellofemoral Ligament (MPFL)	82
Deepening Trochleoplasty System	83
T3 AMZ Instrument System	84
Patella Fracture Set.....	85
Quadriceps Tendon PARS Technique	86

Medial Patellofemoral Ligament (MPFL)

The MPFL convenience pack was developed for reconstruction of the MPFL in cases of acute patellar dislocation or chronic patellofemoral instability. These convenience packs allow the MPFL reconstruction to be accomplished in an anatomic fashion, replicating the native MPFL in position and function. The MPFL convenience pack provides a complete solution for MPFL reconstruction procedures. The pack includes implants, instruments, and an intraoperative radiographic template for identifying the femoral origin of the MPFL for properly positioning the graft in the femur.

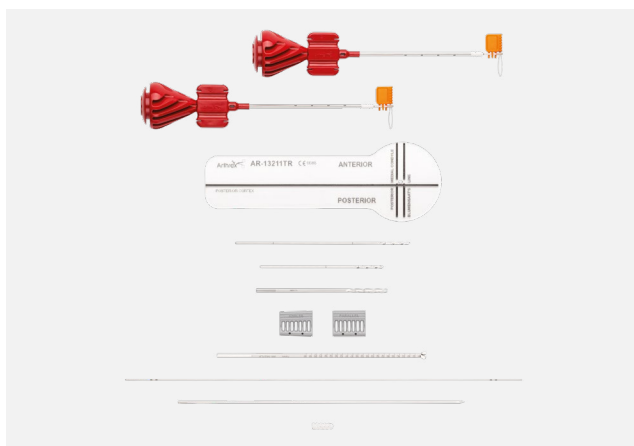

Product Description	Item Number
MPFL Implant System w/ Interference Screw	AR-1360FT-BC
<ul style="list-style-type: none"> ■ Parallel drill guide ■ Angled drill guide ■ 2.4 mm × 120 mm drill tip guide pin ■ 2.4 mm × 170 mm drill tip guide pin ■ 4.0 mm cannulated drill ■ 3.9 mm BioComposite SwiveLock® anchor, qty. 2 ■ MPFL template ■ 2.4 mm guide pin, w/ eyelet ■ 7 mm low-profile reamer ■ 1.1 mm nitinol guidewire ■ 6 mm × 20 mm FastThread™ BioComposite screw 	

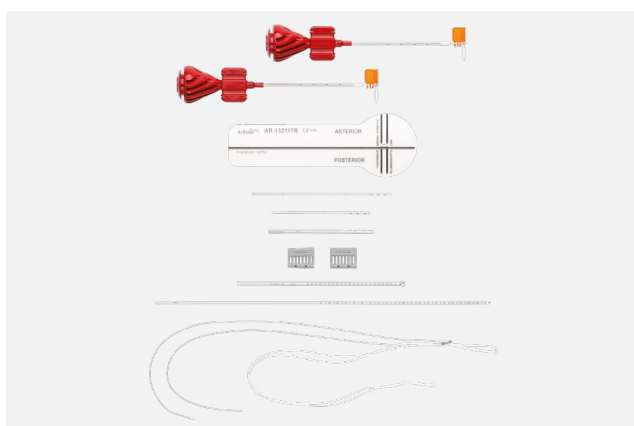

Product Description	Item Number
MPFL Implant System w/ TightRope® Implant	AR-1360TR-BC
<ul style="list-style-type: none"> ■ Parallel drill guide ■ Angled drill guide ■ 2.4 mm × 120 mm drill tip guide pin ■ 2.4 mm × 170 mm drill tip guide pin ■ 4.0 mm cannulated drill ■ 3.9 mm BioComposite SwiveLock anchor, qty. 2 ■ MPFL template ■ 4 mm spade-tip pin ■ 6 mm low-profile reamer ■ ACL TightRope implant 	

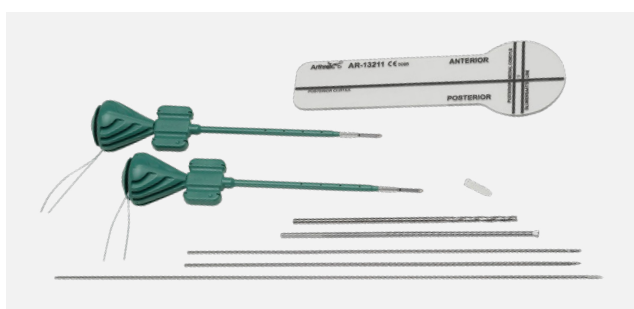

Product Description	Item Number
MPFL Implant System w/ Interference Screw	AR-1360C-CP
<ul style="list-style-type: none"> ■ MPFL template ■ 4.75 mm BioComposite SwiveLock anchor, qty. 2 ■ 6 mm BioComposite interference screw ■ 2.4 mm guide pin, 2.4 mm, qty. 2 ■ 2.4 mm drill-tip guide pin, qty. 2 ■ 7 mm low-profile reamer 	



Product Description	Item Number
MPFL Implant System w/ TightRope Implant	AR-1360CST-CP
<ul style="list-style-type: none"> ■ MPFL template ■ 3.5 mm BioComposite SwiveLock anchor, qty. 2 ■ ACL TightRope implant ■ 4 mm ACL TightRope drill pin, closed eyelet, spade tip ■ 1.1 mm drill-tip guide pin, qty. 2 ■ 6 mm low-profile reamer ■ 3.5 mm cannulated drill 	

Deepening Trochleoplasty System

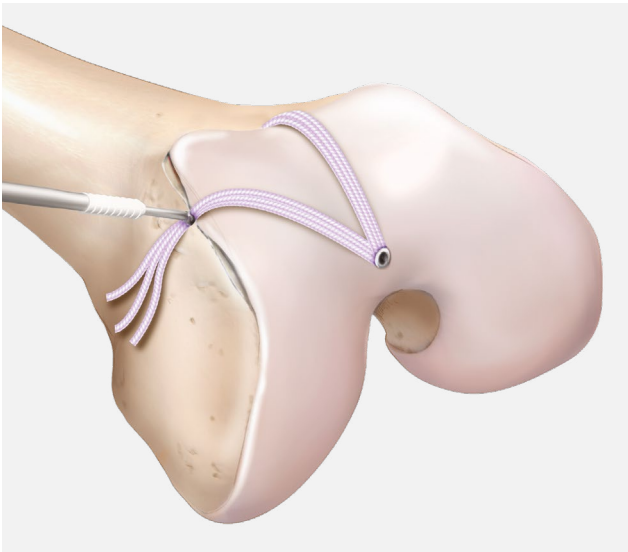

One of the most frequent causes of patellofemoral dysfunction is habitual patella dislocation or subluxation. This system is designed to solve structural causes of patellar instability through a reproducible, deepening trochleoplasty.¹ This instrumentation allows the cartilage layer to be released using a marking hook and burr, at which point the trochlea is deepened to a more natural groove. The cartilage is reattached using a PushLock® or SwiveLock® suture anchor and resorbable sutures. The use of the instrumentation is detailed in the surgical technique (LT1-00004-EN).

Instruments

Product Description	Item Number
Marking hook for trochleoplasty, 3 mm offset	AR-1510TP-03
Marking hook for trochleoplasty, 5 mm offset (a)	AR-1510TP-05

Additional Instruments

Product Description	Item Number
BioComposite PushLock anchor, 3.5 × 19.5 mm	AR-1926BC
Punch for 3.5 mm PushLock anchor	AR-1926P
Side-release RetroConstruction™ handle	AR-1510HR

Product Description	Item Number
Disposable Kit	AR-300-B301S
<ul style="list-style-type: none"> ■ Drill sleeve for trochleoplasty, inner diameter 4.5 mm ■ Burr, 2.9 mm × 162 mm, straight 	

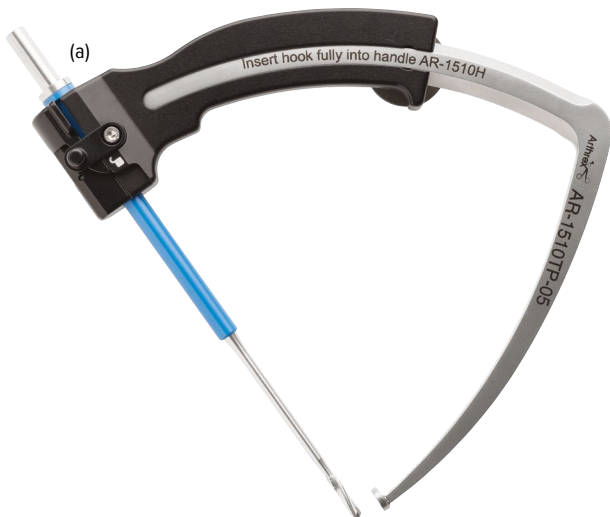

Reference

1. Ryzek DF, Schöttle P. Patellofemoral dysfunction in sports trochleoplasty: indications and techniques. *J Knee Surg.* 2015;28(4):297-302. doi:10.1055/s-0034-1398374

T3 AMZ Instrument System



The T3 AMZ Instrument System was designed to facilitate tibial tubercle osteotomy and transfer in a reproducible manner for extensor mechanism realignment and patellar unloading. The instrument set and disposables kit consists of 3 cutting guide arms, set to 45°, 60°, and 90°. The arms rigidly connect to the tubercle pin and cutting block post, placing the cutting block at specific angles on the tibial tubercle according to the most common cut angles needed.

T3 AMZ Instrument Set (AR-13216S)

Product Description	Item Number
45° horizontal guide, T3 AMZ, 45°, 60°, 90° (a)	AR-13216-01, 02, 03
Saw blade exit indicator, T3 AMZ	AR-13216-04
Tuberosity pin guide, T3 AMZ	AR-13216-05
Soft-tissue retractor, T3 AMZ	AR-13216-06
Cutting block post, T3 AMZ	AR-13216-07
Pin extractor	AR-14016PE
T3 AMZ instrument case	AR-13216C

Product Description	Item Number
T3 AMZ Disposable System	AR-13217
<ul style="list-style-type: none"> ■ Collared breakaway pin, T3 AMZ ■ Tuberosity pin, T3 AMZ ■ Cutting block, T3 AMZ ■ Breakaway pins, T3 AMZ, qty. 2 	

Patella Fracture Set

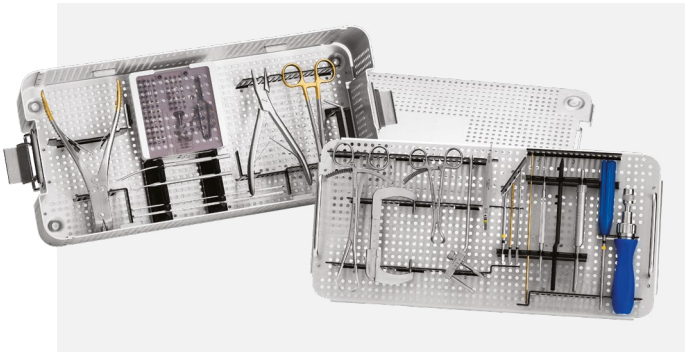

The innovative Patella Fracture Set comprehensively addresses patella fractures. Once the 4.0 mm blunt tip cannulated lag screws are placed, FiberTape® suture on a specially designed 5 in needle can easily be passed through the screws, allowing tension-band fixation. The screw's smooth tip was specifically designed to avoid cutting the suture. This construct has been shown to be stronger than traditional K-wire with cerclage wire constructs.¹

This convenient set also includes the tools needed to perform traditional repairs with K-wires and cerclage wire as well as sternal wire drivers, Weber clamps, drill guides, and stout wire cutters. Unique to this set is an adjustable parallel offset guide, a C-ring drill guide with an incorporated measurement device, and a cerclage wire passer to effectively pass wire through the quad and patellar tendons.

Patella Fracture Set (AR-5050S)

Product Description	Item Number
Patella fracture set case	AR-5050C
4.0 mm blunt-tip cannulated lag screws, 24-60 mm	AR-5051-24 – 60
FiberTape suture w/ needle, 17 in	AR-7237-17LN

Reference

1. Arthrex, Inc. Data on file (APT-03733). Naples, FL; 2018.

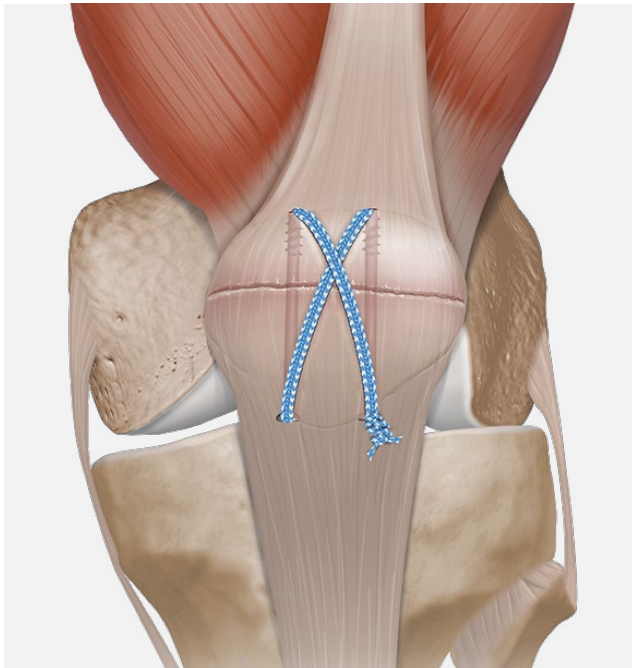

Quadriceps Tendon PARS Technique

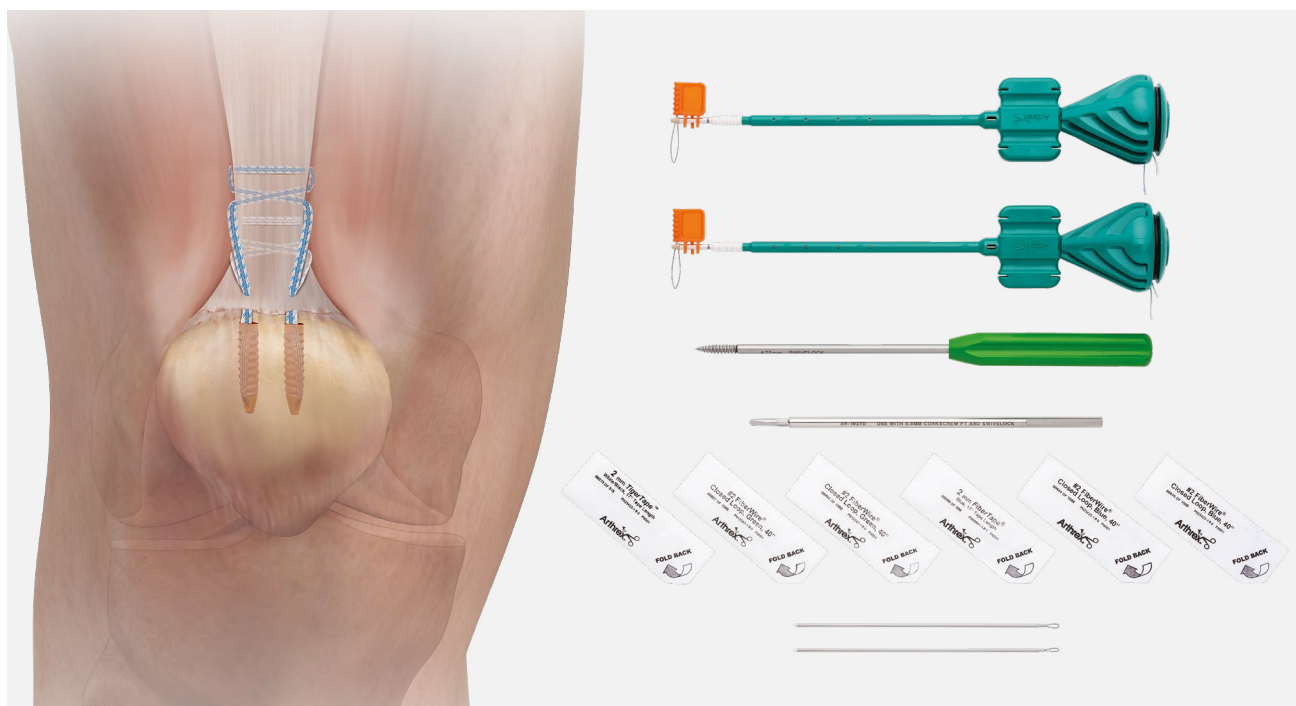

Ruptures of the quadriceps and patellar tendons are common in elite and recreational athletes. Most surgeons treat these injuries surgically to lessen the risk of long-term disability and morbidity. Historically, open techniques have been used for rupture repairs but may be complicated by wound-healing issues and infection. The minimally invasive Percutaneous Achilles Repair System (PARS) technique can be used to treat quadriceps, patellar, and Achilles tendon ruptures.

The PARS system helps facilitate consistently reliable capture of the distal aspect of the quadriceps tendon and includes color-coded FiberWire® and FiberTape® sutures. The anatomically contoured guide is reusable, while the suture and passing needles come packaged in a convenient kit. The PARS system provides the option of using transverse or locking sutures or both. The colored FiberWire sutures offer a more organized approach to identifying and securing matched pairs.

PARS Jig Instrument Set (AR-8860S)

Product Description	Item Number
PARS jig	AR-8860J
PARS tendon elevator	AR-8860J-01
Driver handle w/ AO connection, cannulated	AR-13221AOC
PARS repair instrument case	AR-8860C

Product Description	Item Number
PARS Quad Suture Kit	AR-8929
<ul style="list-style-type: none"> ■ One #2 FiberTape suture, 38 in, blue ■ One #2 FiberTape suture, 38 in, white/black ■ Two #2 FiberWire suture, w/ loops, 40 in, blue ■ Two #2 FiberWire suture, w/ loops, 40 in, green ■ Two 1.6 mm straight needles w/ nitinol loops ■ One spade-tip drill ■ One punch/tap ■ Two 4.75 mm BioComposite SwiveLock® anchors 	

Meniscal Repair

FiberStitch™ 1.5 All-Inside Meniscal Repair.....	90
ZoneNavigator™ System.....	91
Knee Scorpion™ Suture Passer	91
Meniscal Root Marking Hook.....	92
SutureLoc™ Implant.....	93
Meniscal Root Repair.....	94
Meniscus Repair and Resection Set	95
Meniscal Extrusion	96
RAMP Lesion Meniscus Repair.....	97
Suture/Mini SutureTape	97
Meniscal Repair Accessories	98
Micro SutureLasso™ Instrument.....	98

FiberStitch™ 1.5 All-Inside Meniscal Repair



The FiberStitch 1.5 implant is a product of relentless innovation. A low-profile delivery needle results in less tissue morbidity and smaller implants, providing stronger fixation compared to previous FiberStitch implants.¹ The proven superiority of FiberStitch all-suture anchors for all-inside meniscal repair is evident when compared to traditional PEEK implant systems.² Made with 2-0 coreless FiberWire® suture, soft anchors provide secure arthroscopic all-inside knotless meniscal repair.

In addition to a traditional curved delivery device, the FiberStitch 1.5 implant system offers multiple delivery configurations, including a 24° curve, a reverse curve, and a straight needle. All options can be customized for specific curvatures, and the ergonomic handle is designed for single-handed implant delivery. Active implant-deployment technology minimizes needle exposure beyond the meniscus, eliminating the need to past-point the needle.

- **Tissue-sparing, low-profile needle diameter:** A low-profile 1.5 mm-diameter needle creates an atraumatic perforation in the meniscus to deliver smaller all-suture anchors.
- **Multiple delivery options:** The FiberStitch 1.5 implant is available in 4 different needle tip configurations: a standard 12° up curve, a 24° up curve, a 12° reverse curve, and a straight needle. Each needle tip can be bent to unique angles for meniscal penetration. Use the enhanced 24° up curve to reach posterior areas of the meniscus or, when placed on its side, the larger curve can access the anterior meniscus through the contralateral portal.
- **Low-profile suture implants:** The low-profile suture implants replace traditional hard PEEK plastic anchors. Low-profile 2-0 coreless FiberWire suture prevents tissue cut-through and minimizes friction against articular cartilage.¹

- **One-handed deployment:** The ergonomic handle and easy implant deployment wheel allows true one-handed implant delivery.
- **Active implant deployment:** The implants are deployed from the tip of the needle, reducing needle exposure beyond the meniscus and the need to past point the delivery needle.
- **Adjustable depth stop:** The integrated depth stop can be set with a single hand. Convenient markings in 2 mm increments allow setting adjustments from a minimum of 10 mm to a maximum of 18 mm.
- **Flexibility:** The FiberStitch needle is flexible and can be bent to meet unique tear patterns.

Product Description	Item Number
FiberStitch 1.5 implant, 24° up curve (a)	AR-4580-24
FiberStitch 1.5 implant, 12° up curve (b)	AR-4580
FiberStitch 1.5 implant, straight (c)	AR-4580S
FiberStitch 1.5 implant, reverse curve (d)	AR-4580R
Knot pusher/suture cutter w/ portal skid	AR-5845
Knot pusher/suture cutter	AR-5815
Portal skid	AR-4505
Meniscal Viper™ sizing probe	AR-13920P
2-0 Suture cutter, straight	AR-11790
2-0 Suture cutter, 15° up curve	AR-11791

Reference

1. Bisson LJ, Manohar LM, Wilkins RD, et al. Influence of suture material on the biomechanical behavior of suture-tendon specimens: a controlled study in bovine rotator cuff. *Am J Sports Med.* 2008;36(5):907-912. doi:10.1177/0363546508314793
2. Bachmaier S, Krych AJ, Smith PA, et al. Primary fixation and cyclic performance of single-stitch all-inside and inside-out meniscal devices for repairing vertical longitudinal meniscal tears. *Am J Sports Med.* 2022;50(10):2705-2713. doi:10.1177/03635465221107086

ZoneNavigator™ System

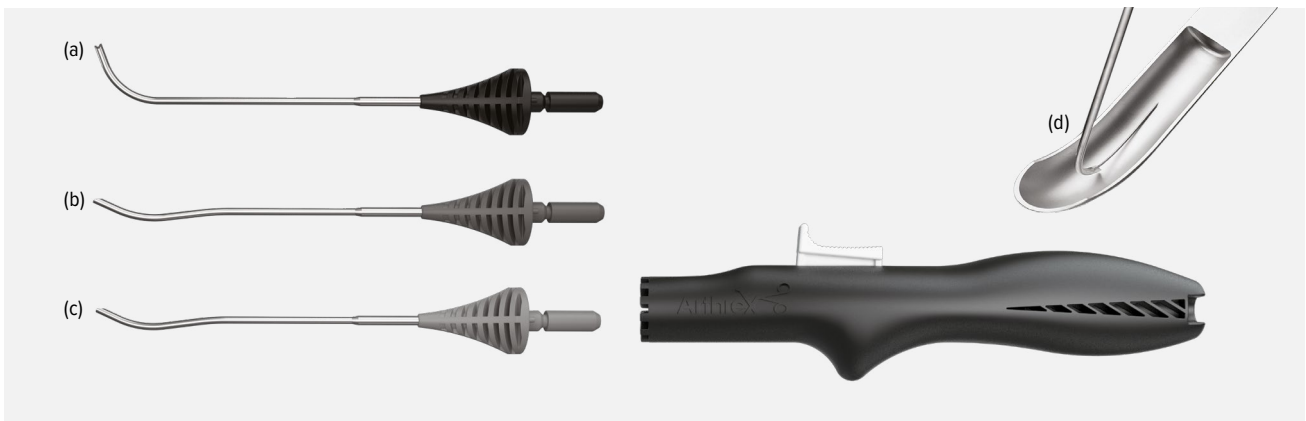

The ZoneNavigator system precisely places suture for inside-out meniscus repair. Three interchangeable cannulas are available to reach any portion of the meniscus for passing vertical or horizontal mattress sutures on the superior or inferior aspect of the meniscus. The ergonomic handle controls needle advancement in 1 cm increments.

Product Description	Item Number
ZoneNavigator system handle	AR-7900
ZoneNavigator system anterior cannula (a)	AR-7905
ZoneNavigator system cannula, left posterior (b)	AR-7910L
ZoneNavigator system cannula, right posterior (c)	AR-7910R
Needle catcher (d)	AR-6660

Suture

Product Description	Item Number
2-0 Mini SutureTape meniscus repair needles, qty. 2	AR-7523
2-0 FiberWire suture meniscus repair needles, small, qty. 2	AR-7223SM

Knee Scorpion™ Suture Passer



The low-profile Knee Scorpion suture passer allows access in tight recesses of the knee for passing 0 or 2-0 FiberWire® suture or 0.9 mm Mini SutureTape. Ergonomically designed for one-handed use, the Knee Scorpion suture passer adds simplicity to suture passing, efficiently passing and retrieving suture in one step. Achieve a variety of suture configurations for soft-tissue repair and fixation using the Knee Scorpion suture passer.

Product Description	Item Number
Knee Scorpion suture passer	AR-12990
Knee Scorpion needle	AR-12990N

Product Description	Item Number
Knot pusher/suture cutter (disposable)	AR-5815
Measurement probe	AR-13920P
2-0 Knot pusher	AR-1296D

Meniscal Root Marking Hook

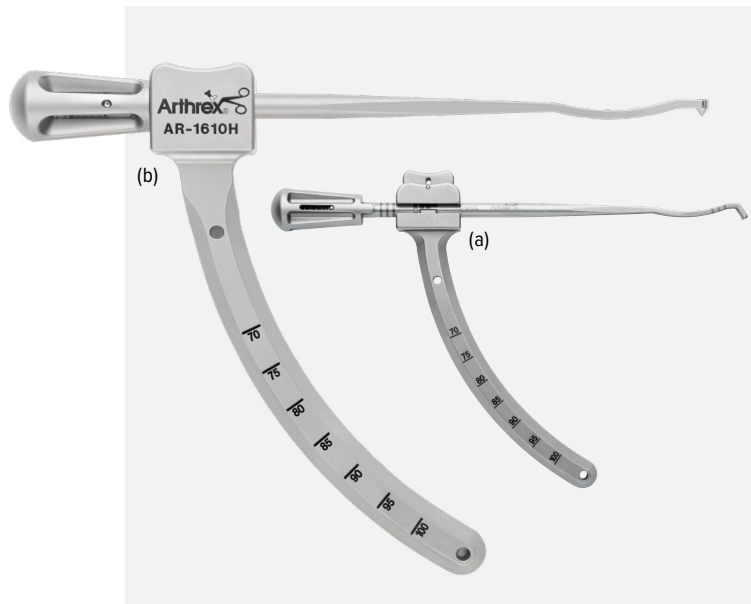

Based on surgeon preference, Arthrex offers 2 meniscal root marking hooks. The over-the-back marking hook **(a)** sits securely over the back of the tibia for stable drilling using a 6 mm FlipCutter® II reamer for socket preparation. The over-the-back hook and ratcheting drill sleeve provide 2-point fixation and guided stability during drilling.

The locking mechanism aids insertion into the joint, and the low-profile design avoids intact anatomy while allowing arthroscopic visualization of the repair site. Choose from 3 offsets for bone socket preparation: 5 mm, 7.5 mm, or 10 mm from the posterior tibia.

The point-to-point guide **(b)** allows surgeons to directly target their drill location at the meniscal root. Laser markings at the distal tip of the guide allow for accurate targeting, while the small cone helps secure the surgeon's position while drilling. With the spring-loaded system, surgeons can dial in their angle of approach and lock the guide in place at 10°, 20°, 30°, and 40° in either direction.

Meniscal Root Marking Hooks

Product Description	Item Number
Locking guide	AR-1610LG
Over-the-back meniscal root marking hook	AR-1610MR
Point-to-point meniscal root marking hook	AR-1610H

SutureLoc™ Implant

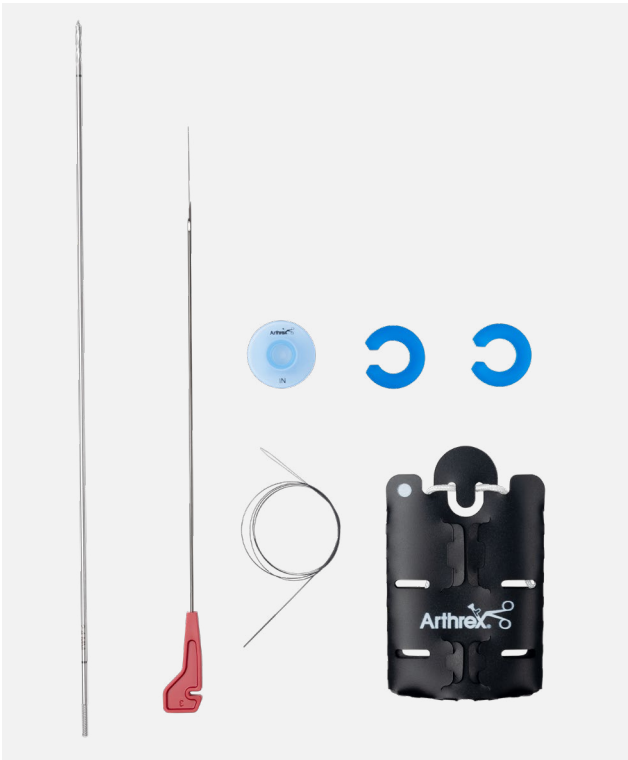

The SutureLoc implant is an all-suture, knotless anchor specifically designed for joint-line fixation of the meniscal root. This revolutionary anchor eliminates the need for a posterior medial portal, which is commonly used in direct tibial fixation techniques, making the repair more reproducible. The 2.4 mm cannulated drill pin leaves more bone intact while delivering the SutureLasso™ wire directly to the footprint of the meniscal root. Once the anchor has been passed, the 2 repair sutures can be passed through the tissue in a variety of stitch patterns. The knotless technology is retensionable, allowing surgeons to dial in their repair.

Features and Benefits

- 237 N of pull-out strength and 0.34 mm of cyclic displacement¹
- Double-loaded knotless mechanism allows for 2 repair stitches with only 1 anchor pass, reducing steps from previous techniques
- Soft, all-suture implant
- Minimal bone removal with a smaller, 2.4 mm drill pin and no need to decorticate
- Simple, reproducible suture passing
- Suture tension can be controlled and adjusted under direct visualization
- Repair suture converted inline, eliminating the “killer curve” and allowing for a smooth conversion

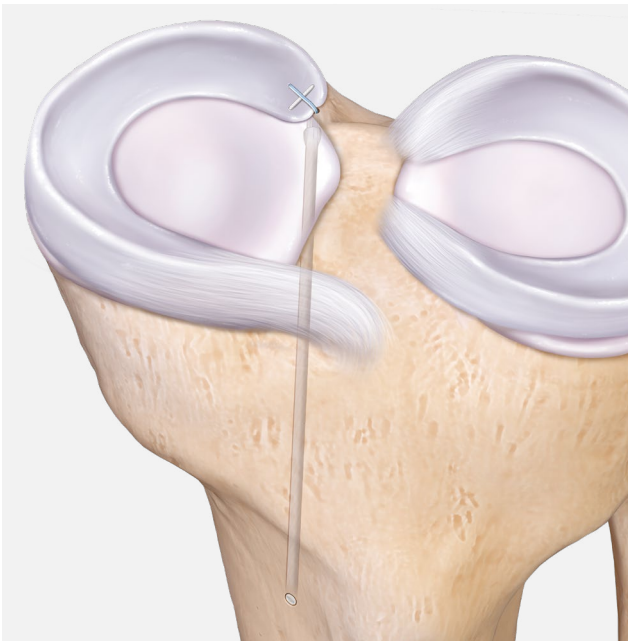

Product Description	Item Number
SutureLoc implant system	AR-4551

Reference

1. Arthrex, Inc. Data on file (APT-05761A). Naples, FL; 2022.

Meniscal Root Repair



Complete transtibial meniscal root repairs with the convenient Meniscal Root Repair Kit, which contains an 8 mm × 3 mm PassPort Button™ cannula and a Knee Scorpion™ needle for passing 2-0 and 0 FiberWire® suture with the Knee Scorpion™ suture passer. Various suture configurations are possible with 2-0 FiberStick™ and 0 FiberLink™ and TigerLink™ sutures. Prepare the bone socket and create the transtibial tunnel using the 6 mm FlipCutter® II reamer. Secure the repair with a 4.75 mm BioComposite SwiveLock® anchor.

Product Description	Item Number
Meniscal Root Repair Kit w/ BioComposite SwiveLock Anchor	AR-4550BC
Knee Scorpion needle FlipCutter II reamer, 6 mm PassPort Button cannula, 8 mm × 3 cm 2-0 FiberStick 1, qty. 2 SutureLasso™ needle w/ nitinol passing wire 0 FiberLink suture, 0 TigerLink suture BioComposite SwiveLock anchor, 4.75 mm × 19.1 mm Spade-tip drill bit SwiveLock anchor tap, for hard bone	

Product Description	Item Number
Meniscal Root Repair Kit w/ PEEK SwiveLock Anchor	AR-4550P
Knee Scorpion needle FlipCutter II reamer, 6 mm PassPort Button cannula, 8 mm × 3 cm 2-0 FiberStick suture, qty. 2 SutureLasso needle w/ nitinol passing wire 0 FiberLink suture, 0 TigerLink suture PEEK SwiveLock anchor, 4.75 mm × 19.1 mm Spade-tip drill bit SwiveLock anchor tap, for hard bone	

Meniscus Repair and Resection Set



The Meniscus Repair and Resection Set contains the most popular instruments for addressing various meniscus procedures, including meniscal root repair, all-suture meniscus repair, and meniscus contouring. The instruments are held securely within the slotted silicone pads for protection. A removable shelf uncovers an open space for placement of additional instrumentation.

Meniscus Repair and Resection Instrument Set (AR-4555S)

Product Description	Item Number
Point-to-point marking hook	AR-1610H
Knee Scorpion suture passer	AR-12990
Mini suture retriever, 2.75 mm, straight	AR-11540
MegaBiter™ resector, straight	AR-41006
MegaBiter resector, up curve	AR-41026
MegaBiter resector, straight left	AR-41006L
MegaBiter resector, straight right	AR-41006R
Hook probe, 3.4 mm	AR-10010
Meniscus repair rasp	AR-4130
Side-release RetroConstruction™ handle	AR-1510HR
Drill sleeve for side-release handle, 2.4 mm, ratcheting	AR-1510FD-24
Stepped drill sleeve for side-release handle, ratcheting	AR-1510FS-7
Guide pin sleeve for stepped drill sleeve, 2.4 mm	AR-1204F-24I
Meniscus repair and resection instrument case	AR-4555C

Meniscal Extrusion



Meniscal extrusion, which results in compromised load-bearing function of the medial meniscus, is increasingly being recognized as clinically significant.¹ One cause of medial meniscal extrusion is insufficiency of the medial capsule and meniscotibial ligaments (MTL). Knee capsule repair is effective in reducing meniscal extrusion resulting from MTL insufficiency and thereby restoring the potential for improved load sharing across the medial compartment.² The Knee Capsule Implant System was designed to facilitate reproducible repair of the medial capsule.

Confirm meniscal extrusion and note the presence of meniscotibial ligament insufficiency, meniscal reducibility, and the anterior and posterior extents of the lesion. Included in the Knee Capsule Repair Implant System are 2 knotless SutureTak® percutaneous insertion anchors, the GAP™ (Guided Arthroscopic Placement) drill guide and 3 percutaneous K-wires. The GAP guide allows reproducible placement of the implants at a distance 3 mm below the medial tibial joint line.

Product Description	Item Number
Knee Capsule Repair System w/ GAP Guide	AR-5875-2

References

1. Berthiaume MJ, Raynauld JP, Martel-Pelletier J, et al. Meniscal tear and extrusion are strongly associated with progression of symptomatic knee osteoarthritis as assessed by quantitative magnetic resonance imaging. *Ann Rheum Dis.* 2005;64(4):556-563. doi:10.1136/ard.2004.023796
2. Paletta GA Jr, Crane DM, Konicek J, et al. Surgical treatment of meniscal extrusion: a biomechanical study on the role of the medial meniscotibial ligaments with early clinical validation. *Orthop J Sports Med.* 2020;8(7):2325967120936672. doi:10.1177/2325967120936672

RAMP Lesion Meniscus Repair



The RAMP lesion is a disruption of the meniscotibial ligament and the posteromedial meniscus in the meniscocapsular zone. The lesion is commonly associated with ACL injuries and is often misdiagnosed.¹

Disruption of the posterior horn of the medial meniscus could lead to excessive forces within the knee joint and surrounding structures. The QuickPass™ SutureLasso™ suture passer is preloaded with a 2-0 FiberStick™ suture and offered with a left or right 25° curve and a 1.5 mm tip.

Product Description	Item Number
QuickPass SutureLasso suture passer, 25°, curved right	AR-6068-25R
QuickPass SutureLasso suture passer, 25°, curved left	AR-6068-25L

Reference

1. Peltier A, Lordin TD, Lustig S, et al. Posteromedial tears may be missed during anterior cruciate ligament reconstruction. *Arthroscopy*. 2015;31(4):691-698. doi:10.1016/j.arthro.2014.12.003

Suture/Mini SutureTape

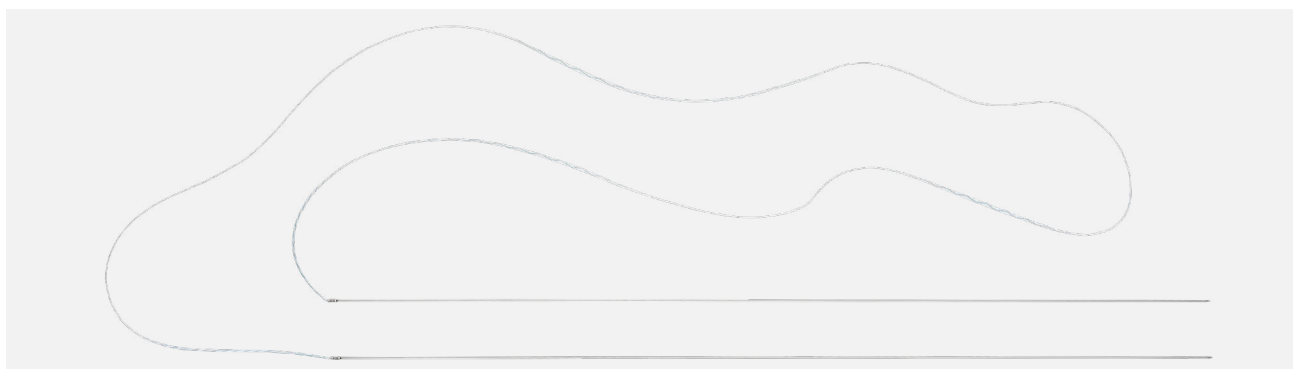

The FiberWire® suture meniscus repair needles are made of standard-length stainless steel with a 38 in length of 2-0 FiberWire suture or Mini SutureTape. The 0.9 mm Mini SutureTape disperses the compressive force across a larger area compared to round suture. This allows surgeons to perform standard inside-out meniscus repair with all the benefits of FiberWire suture and SutureTape.

Product Description	Item Number
2-0 Mini SutureTape meniscus repair needles	AR-7523
2-0 Mini SutureTape, no needles	AR-7521

2-0 FiberWire Meniscus Repair Needles

Product Description	Item Number
2-0 FiberWire Suture meniscus repair needles, qty. 2	AR-7223
2-0 FiberWire Suture meniscus repair needles, small, qty. 2	AR-7223SM

2-0 FiberLink™ and TigerLink™ SutureTape

Product Description	Item Number
FiberLink SutureTape, 0.9 mm, white/black	AR-7559
TigerLink SutureTape, 0.9 mm, white/black	AR-7559T

Meniscal Repair Accessories

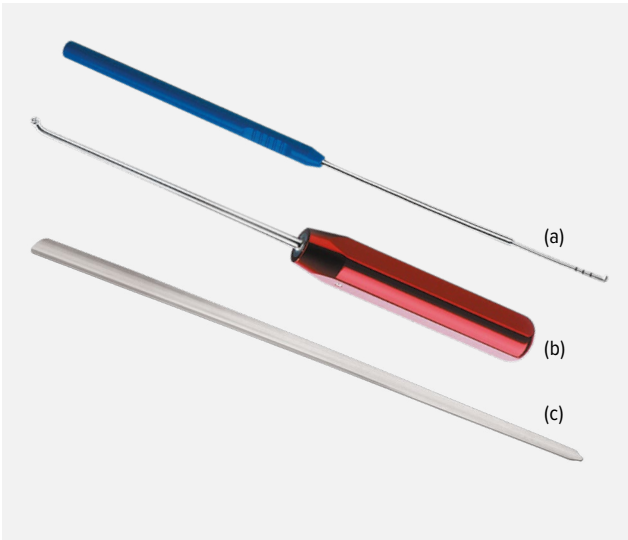

Use the malleable meniscal dart measuring probe to measure the width of the meniscus. The angled tip of the meniscus repair rasp is ideally shaped to access inside the meniscal tear for debridement prior to the repair. The malleable portal skid can be used to clear access into the knee joint and can be bent for anatomical customization.

Product Description	Item Number
Meniscal Dart™ measuring probe (a)	AR-4008
Meniscus repair rasp (b)	AR-4130
Portal skid with MeniscAssist (c)	AR-4505
Meniscal Viper™ sizing probe	AR-13920P

Micro SutureLasso™ Instrument

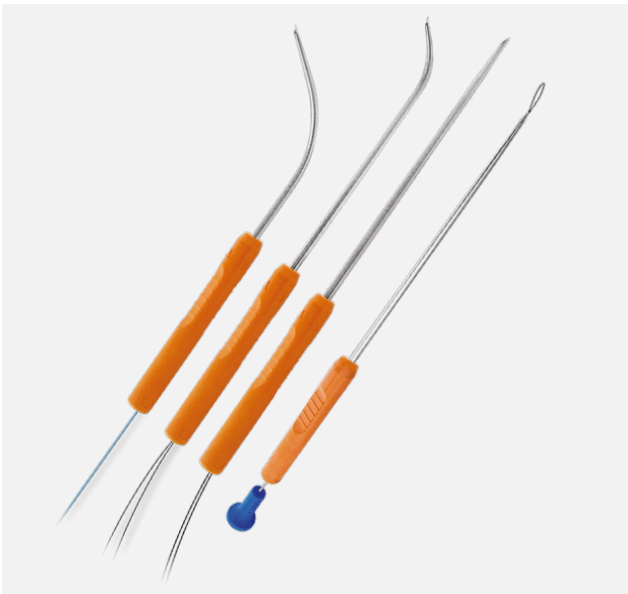

The Micro SutureLasso instrument, a 6 in long cannulated stainless steel shaft with an ergonomic plastic handle, facilitates the placement of simple and mattress stitches for repairing various meniscal tears using an outside-in approach. These strong, stainless steel needles come preloaded with a braided nitinol wire for use as a suture shuttle and are available in small-curve, large-curve, and straight configurations for accessing hard-to-reach areas. Each Micro SutureLasso needle tapers from 16 Ga proximally at the handle junction to 20 Ga distally along the last 20 mm of the tip. As an alternative, all FiberStick™ sutures can be passed down the instrument with ease.

Product Description	Item Number
Micro SutureLasso suture passer, small curve	AR-8701
Micro SutureLasso suture passer, large curve	AR-8702
Micro SutureLasso suture passer, straight	AR-8703
Micro SutureLasso retriever	AR-8701SR

Optional Accessories

Product Description	Item Number
FiberStick suture, #2 FiberWire® suture, 50 in (blue), one end stiffened, 12 in	AR-7209
TigerStick® suture, #2 TigerWire® suture, 50 in (white/black), 1 end stiffened, 12 in	AR-7209T
2-0 FiberStick suture, 2-0 FiberWire suture, 50 in (blue), 1 end stiffened, 12 in	AR-7222
2-0 Mini SutureTape	AR-7521
2-0 Mini SutureTape meniscus repair needles	AR-7523
2-0 FiberWire suture meniscus repair needles	AR-7223
2-0 FiberWire suture meniscus repair needles, small	AR-7223SM

Meniscal Resection

Arthroscopic Meniscectomy Instrument Set.....	102
MegaBiter™ Tissue Resection Series	103
Nano Instruments	103

Arthroscopic Meniscectomy Instrument Set



The lightweight Arthroscopic Meniscectomy Instrument Set contains ArthroCare's most popular hand instruments. The anodized aluminum case can safely store up to 20 arthroscopy instruments, which are held securely in slotted silicone pads with the tips in the open position for protection and easy identification.

Arthroscopic Meniscectomy Instrument Set (AR-2200CS)

Product Description	Item Number
Punch, slender straight tip, ø2.75 mm straight shaft	AR-11100
Punch, large straight tip, ø2.75 mm straight shaft	AR-11200
Grasper, mini straight tip, ø2.75 mm 15° up-curved shaft w/ SR handle	AR-11910SR*
Punch, standard straight tip, ø3.4 mm straight shaft	AR-12000
Scissor, serrated-tooth straight tip, ø3.4 mm straight shaft	AR-12140
WideBiter™ punch, 15° up tip, ø3.4 mm, straight shaft	AR-12240
WideBiter punch, 15° up tip, ø3.4 mm 15° up-curved shaft	AR-12241
Grasper, blunt straight tip, ø3.4 mm straight shaft w/ SR handle	AR-12500SR*
Punch, medium reverse straight tip, ø3.4 mm straight shaft	AR-12530
Punch, medium 45° right angled tip, ø3.4 mm straight shaft	AR-12800
Punch, medium 45° left angled tip, ø3.4 mm straight shaft	AR-12810
WideBiter punch, 90° right rotary tip, ø3.4 mm straight shaft	AR-12912
WideBiter punch, 90° left rotary tip, ø3.4 mm straight shaft	AR-12913
Punch, rotary w/ scoop 90° right tip, ø3.4 mm straight shaft	AR-12940
Punch, rotary w/ scoop 90° left tip, ø3.4 mm straight shaft	AR-12950
Grasper, alligator-hook tip, ø4.2 mm, straight shaft w/ SR handle	AR-13600SR*
MegaBiter™ resector, 5.5 mm × 2.5 mm, straight tip	AR-41006
MegaBiter resector, 5.5 mm × 2.5 mm, up curved tip	AR-41026
MegaBiter resector, 5.5 mm, straight tip, left cut	AR-41006L
MegaBiter resector, 5.5 mm, straight tip, right cut	AR-41006R
Hand instrument case, 20 slots	AR-2200C

*SR graspers are available upon request at no additional charge.

MegaBiter™ Tissue Resection Series



The MegaBiter resector has transformed meniscal resection with its large, 5.5 mm bite width. Its low-profile design helps reach tight recesses in joint spaces. The straight MegaBiter resector provides the same bite width without the curved tip, allowing access to tissue in tighter joint spaces.

Product Description	Item Number
MegaBiter resector, 5.5 mm × 2.5 mm, straight tip (a)	AR-41006
MegaBiter resector, 5.5 mm × 2.5 mm, up curved tip (b)	AR-41026
MegaBiter resector, 5.5 mm, straight tip, left cut (d)	AR-41006L
MegaBiter resector, 5.5 mm, straight tip, right cut (c)	AR-41006R

Nano Instruments

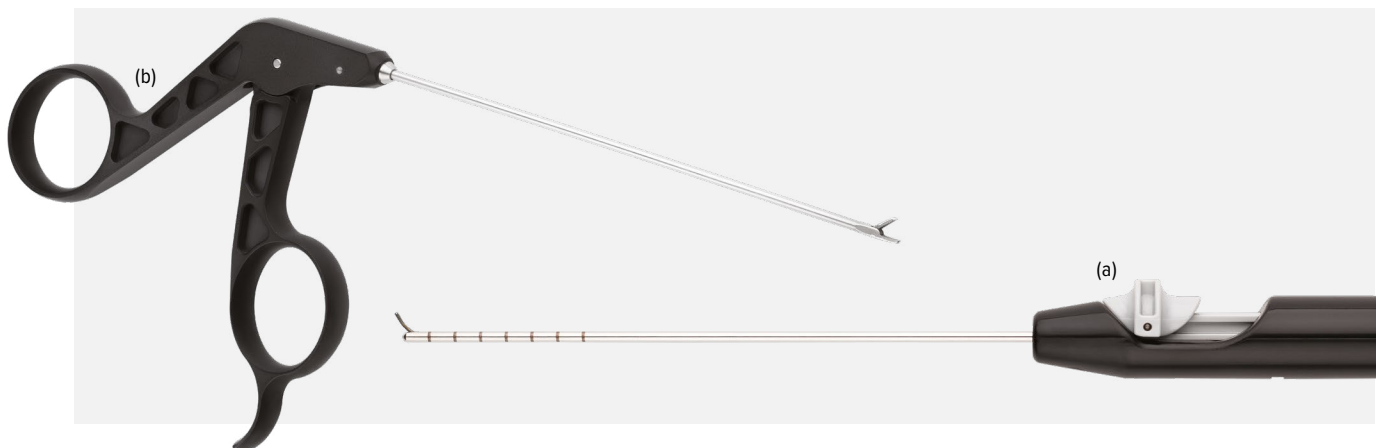

Harnessing 20 years of engineering excellence in designing arthroscopic hand instrumentation, Arthrex has produced the next generation in tissue resection and extraction instruments that are sharp and strong enough to resect and remove meniscal tissue. The low-profile tip design facilitates safe introduction into most tight joint spaces without the need for a limb holder.

Product Description	Item Number
NanoScope™ probe (a)	AR-10100N
NanoGrasper, straight, disposable, 130 mm (b)	AR-10913D-1
NanoScissor, straight, disposable, 130 mm	AR-10915D-1
NanoBiter, straight, disposable, 130 mm	AR-10911D-1
NanoBiter, 15° up, disposable, 130 mm	AR-10922D-1

Osteochondral Repair

Chondral Dart™ Implant.....	106
Osteochondral Flap Repair System.....	106
Marrow Stimulation	107
AutoCart™ Procedure.....	108
3 mm Bio-Compression Screw	109

Chondral Dart™ Implant



The bioabsorbable PLLA Chondral Dart implant has a unique, double-reversed barbed design to facilitate superior fixation and compression of osteochondral flap tears up to 2 cm in diameter.

The 18 mm-long, 1.3 mm-diameter Chondral Dart implant provides secure fixation under the hyaline cartilage surface, eliminating contact with sensitive articulating surfaces.

Product Description	Item Number
Chondral Dart implant, 1.3 mm × 18 mm, sterile, qty. 5	AR-4005B-18

Osteochondral Flap Repair System



This single-use, multishot instrumentation offers controlled management of larger fragments using multiple darts. Clear guide sleeves in 2- or 4-holed sizes atraumatically compress the fragment throughout the procedure while allowing the surgeon to see the passage of instruments and underlying fragment through the sheath. The pins' step design allows easy access for drilling and removal; the pins stabilize the guide sleeve to create necessary pilot holes for implant insertion.

Product Description	Item Number
Osteochondral Flap Repair Single-Shot Set, sterile, single use	AR-4009S
Osteochondral flap repair single-shot sheath	
Osteochondral flap repair single-shot dart inserter	
Osteochondral flap repair single-shot drill	
Osteochondral flap repair cannula	

These instruments compress osteochondral fragments when inserting darts below the surface of the articular cartilage for strong, bioabsorbable fixation of smaller osteochondral flaps of 5 mm to 20 mm in diameter.

Use these single-shot instruments to manually insert darts one at a time. Place the sheath against the fragment to provide compression. The stainless steel trocar passes through the sheath to a controlled depth. Insert the 1.3 mm-diameter PLLA dart directly into the sheath, which is positioned firmly over the drilled hole. The controlled dart depth ensures that the dart is countersunk 2 mm below the surface of the cartilage into subchondral bone.

Product Description	Item Number
Osteochondral Flap Repair Multishot Set, sterile, single use	AR-4095S
Osteochondral flap repair single-shot sheath	
Osteochondral flap repair single-shot dart inserter	
Osteochondral flap repair single-shot drill	
Osteochondral flap repair cannula	
Osteochondral flap repair blunt pin	
Osteochondral flap repair 2-hole guide sleeve and 4-hole guide sleeve	
Osteochondral flap repair drill pins, S, M, L, and XL	
Chondral Dart™ implant, 1.3 mm × 18 mm	

Marrow Stimulation



Chondro picks are designed to perforate the base of osteochondral defects. Various angled tips and shaft configurations allow access to most defects in the patellofemoral joint. Tips hardened with titanium nitride provide visual 3 mm depth control during defect perforation. Delrin®* material endcaps allow use of a mallet to assist in perforation.

Chondral Pick Set (AR-1760S)

Product Description	Item Number
Chondro pick, 20°	AR-1761
Chondro pick, 40°	AR-1762
Chondro pick, 60°	AR-1763
Chondro pick, 25°, curved tip	AR-1764
Chondro pick, 35°, curved tip	AR-1765
Chondro pick instrument case	AR-1766

Used in conjunction with motorized shaver handpieces, the PowerPick™ microfracture instrument provides a powered option for quickly perforating defects using the microdrilling technique. Varying shaft angles and a 4 mm- or 6 mm-depth drill tip allow access to most defects in an array of operative sites.

PowerPick Microfracture Instruments

Product Description	Item Number
PowerPick XL microfracture instrument, 45°, ø1.5 mm × 13 cm	AR-8150PX-45
PowerPick microfracture instrument, 30° (a)	AR-8150PP-30
PowerPick microfracture instrument, 45°	AR-8150PP-45

*Delrin is a registered trademark of DuPont.

AutoCart™ Procedure

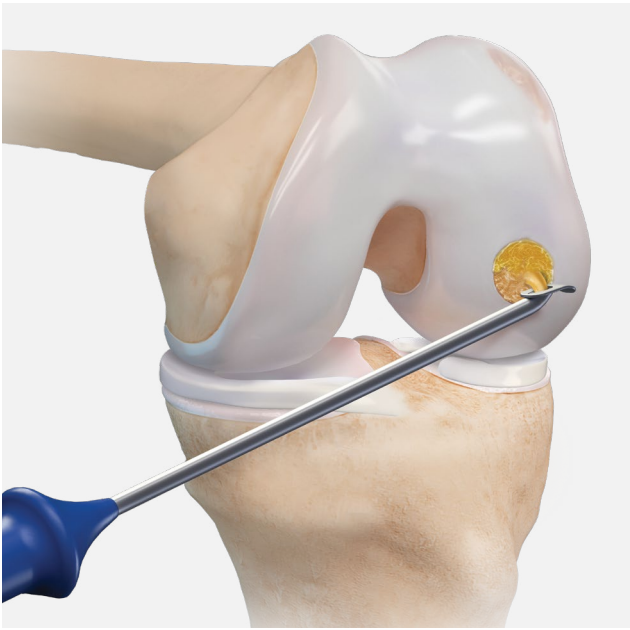

The AutoCart technique is a single-stage, matrix-augmented, autologous chondrocyte transplantation. The technique combines osteochondral tissue collected using the GraftNet™ device with BioCartilage® extracellular matrix (ECM), creating an optimal scaffold augmented with the patient's own cells. When the collected GraftNet osteochondral tissue mixed with BioCartilage extracellular matrix is combined with Arthrex ACP® platelet-rich plasma (PRP) and then sealed in the defect with Thrombinator™ autologous thrombin serum, this technique offers a single-stage biologic option for treating focal osteochondral defects.

Product Description	Item Number
BioCartilage ECM	
BioCartilage ECM, 1 cc	ABS-1010-BC
Mixing and Delivery Kit, large joint (includes mixing syringe and arthroscopic delivery needle, obturator, funnel, fat pad retractor, and cannulated swabs)	ABS-1000-L
Mixing and Delivery Kit, small joint (includes mixing syringe and cap, arthroscopic delivery needle, obturator, funnel, fat pad retractor, and cannulated swabs)	ABS-1000-S
Mixing and Delivery Kit, hip joint (includes mixing syringe and cap, arthroscopic delivery needle, obturator, funnel, fat pad retractor, and suction adaptor)	ABS-1000-H
Arthrex ACP Double-Syringe System	
Arthrex ACP double syringe	ABS-10014
Arthrex ACP Kit, series I	ABS-10011
Arthrex ACP Kit, series II	ABS-10012
ACP Max™ PRP System	
ACP Max PRP system w/ ACD-A	ABS-10015
ACP Max PRP system	ABS-10013
Angel® cPRP System	
Angel PRP kit	ABS-10061T
Thrombinator System	
Thrombinator autologous thrombin serum	ABS-10080
Viscous Delivery Systems	
Applicator assembly 10 cc, 1:1 ratio	SA-3310
Dual cannula, malleable, 20 ga × 5 cm (2 in)	SA-3615
Dual cannula, malleable, 20 ga × 10 cm (4 in)	SA-3618
Dual cannula, malleable, 20 ga × 26 cm (10.25 in)	SA-3620
Shaver Blades and Bone Preparation	
Sabre shaver blade, 3 mm × 7 cm	AR-7300SR
Sabre shaver blade, 4 mm × 13 cm	AR-8400SR
Bone cutter, 3.8 mm × 13 cm	AR-8380BC
Bone cutter, 4 mm × 13 cm	AR-8400BC
PowerPick™ instrument, 30°, 1.5 mm × 13 cm	AR-8150PP-30
PowerPick instrument, 45°, 1.5 mm × 13 cm	AR-8150PP-45
PowerPick XL instrument, 45°, 6 mm drill depth	AR-8150PX-45

3 mm Bio-Compression Screw

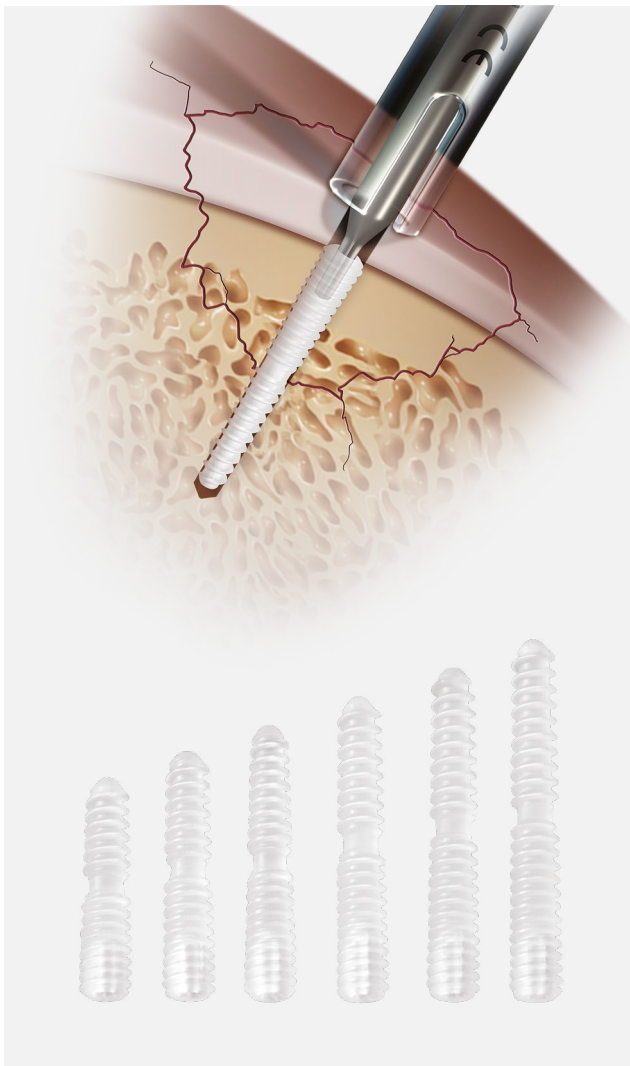

For fracture and osteotomy fixation in periarticular applications, this screw offers interfragmentary compression and a headless profile.

3 mm Bio-Compression Screw Instrumentation Set (AR-5025S)

Product Description	Item Number
Bio-Compression screwdriver, 2.7 mm, noncannulated	AR-5025DB
Small handle w/ AO connection	AR-2001AOT
Bio-Compression screw dilator tap, 20 mm	AR-5025TB
Bio-Compression screwdriver guide, 20 mm	AR-5025G
Bio-Compression screw drill bit, 20 mm	AR-5025TD
Bio-Compression cannulated dilator tap, 16 mm	AR-5025TBC-16
Bio-Compression cannulated dilator tap, 18 mm	AR-5025TBC-18
Bio-Compression cannulated dilator tap, 20 mm	AR-5025TBC
Bio-Compression cannulated dilator tap, 22 mm	AR-5025TBC-22
Bio-Compression cannulated dilator tap, 24 mm	AR-5025TBC-24
Bio-Compression cannulated dilator tap, 26 mm	AR-5025TBC-26
Compression screw cannulated drill bit, 16 mm	AR-5025TDC-16
Compression screw cannulated drill bit, 18 mm	AR-5025TDC-18
Compression screw cannulated drill bit, 22 mm	AR-5025TDC-22
Bio-Compression screw cannulated drill bit, 20 mm	AR-5025TDC
Bio-Compression screw cannulated drill bit, 24 mm	AR-5025TDC-24
Bio-Compression screw cannulated drill bit, 26 mm	AR-5025TDC-26
Bone reduction forceps w/ teeth	AR-4160FT
Depth device, cannulated	AR-5025DG
Bio-Compression screw instrumentation case	AR-5025C

Implants (Noncannulated)

Product Description	Item Number
Bio-Compression screw, 3-3.7 mm × 16 mm	AR-5025B-16
Bio-Compression screw, 3-3.7 mm × 18 mm	AR-5025B-18
Bio-Compression screw, 2.7-3.7 mm × 20 mm	AR-5025B-20
Bio-Compression screw, 3-3.7 mm × 22 mm	AR-5025B-22
Bio-Compression screw, 3-3.7 mm × 24 mm	AR-5025B-24
Bio-Compression screw, 3-3.7 mm × 26 mm	AR-5025B-26

Disposable

Product Description	Item Number
Guidewire w/ trocar tip, 0.045 in (1.1 mm)	AR-5025K*

Optional

Product Description	Item Number
Bio-Compression screw instrument case	AR-5025C

*Necessary for procedure; order separately.

Osteochondral Transplant

Autograft OATS® 2.0 Set	112
Retrograde OATS® System	113
IntraOsseous BioPlasty® (IOBP®) Technique	114
Fresh Osteochondral Allografts (OCAs)	115
Allograft OATS® System.....	116
BioUni® OATS® System	117

Autograft OATS® 2.0 Set



The OATS (Osteochondral Autograft Transfer System) 2.0 set includes depth stop features to control the recipient site and donor plug to either 8 mm or 13 mm lengths. The single-use OATS set facilitates harvesting of 6 mm, 8 mm, 10 mm, or 12 mm osteochondral cartilage cylinders from a donor site superior and lateral to the notch or above the sulcus terminalis. A recipient socket, sized to the appropriate depth, is created in the chondral defect to accept the donor graft.

The bone cylinder can be visualized through the clear graft delivery tube while it is inserted with the collared pin delivery system for press-fit fixation. The completely disposable, size-specific system includes a recipient reamer, donor harvester, alignment rod, tamp, graft delivery tube, core extruder for controlled push-in core insertion, and optional graft driver.

All of the system components are provided sterile, packaged in a rigid thermoformed tray, and nestled in individual compartments.

Single-Use OATS 2.0 Sets

Product Description	Item Number
Single-use OATS set, 6 mm	ABS-8981-06S
Single-use OATS set, 8 mm	ABS-8981-08S
Single-use OATS set, 10 mm	ABS-8981-10S
Single-use OATS set, 12 mm	ABS-8981-12S

OATS Sizer/Tamp Instruments Set (AR-1985S)

Product Description	Item Number
Sizer/tamp, 6 mm, red	AR-1985-06
Sizer/tamp, 8 mm, purple	AR-1985-08
Sizer/tamp, 10 mm, black	AR-1985-10
OATS sizer/tamps instrument case	AR-1985C

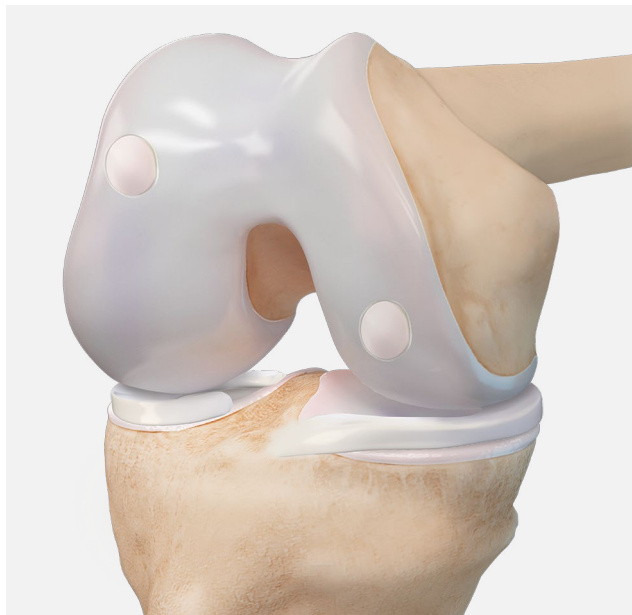

Retrograde OATS® System



Rely on the retrograde OATS set to harvest precisely angled 10 mm osteochondral hyaline cartilage cylinders for resurfacing lesions in the tibial plateau and patella. Create a recipient tunnel retrograde to the lesion site then harvest a cylinder from a donor site above the sulcus terminalis. Exchange the cylinder from one donor harvester to another, enabling the bone cylinder to be implanted into the recipient tunnel, leading with the articular surface. Gently extrude the bone cylinder into the recipient tunnel slightly countersunk to the articular surface. Use a bioabsorbable interference screw to achieve final flush seating and backup to the press-fit fixation.

The size-specific system includes 2 single-use OATS harvesters; collared pins in 10°, 20°, and 30° angles; bone core exchange tube; guide pin; size-specific cannulated drills; and core extruder.

All system components are provided sterile, packaged in a rigid thermoformed tray, and nestled in individual compartments.

Product Description	Item Number
Retrograde OATS set, 10 mm	AR-1982-10S
OATS marking hook	AR-1510M

IntraOsseous BioPlasty® (IOBP®) Technique

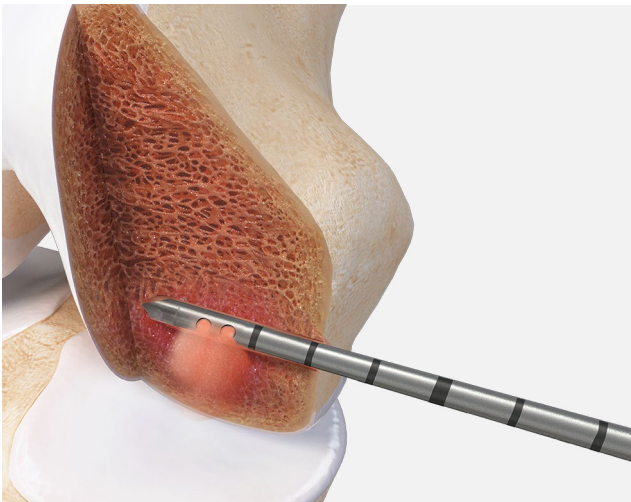
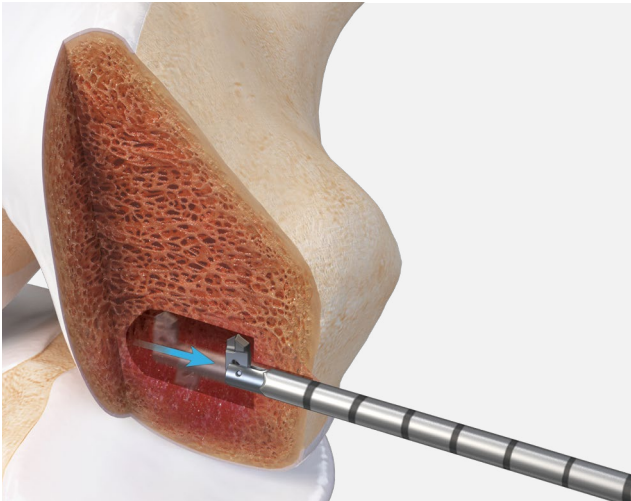

The IntraOsseous BioPlasty (IOBP) surgical technique is a treatment option for subchondral bone pathologies resulting from acute or chronic injury, including bone marrow lesions associated with insufficiency fractures, persistent bone bruises, osteoarthritis, and early stages of avascular necrosis. Arthrex offers a biologic option for the treatment of these pathologies by performing a core decompression of the lesion and a direct application of cPRP from bone marrow aspirate (BMA) using the Angel® cPRP and bone marrow processing system with AlloSync™ Pure demineralized bone matrix (DBM) to encourage physiologic bone remodeling and repair.

Product Description	Item Number
IntraOsseous BioPlasty knee kit, open-tip	ABS-2000-OT
IntraOsseous BioPlasty knee kit, open-tip w/ decompression device	ABS-2001-OT
IntraOsseous BioPlasty knee kit, closed-tip	ABS-2000-CT
AlloSync Pure DBM, 2.5 cc	ABS-2010-02
AlloSync Pure DBM, 5.0 cc	ABS-2010-05
Angel® cPRP from bone marrow aspiration kit	ABS-10062
Angel cPRP system	ABS-10066
BioSurge™ I System, 2.5 cc Allosync Pure DBM w/ Angel cPRP and BMA tray	ABS-2016-01
BioSurge II System, 5.0 cc Allosync Pure DBM w/ Angel cPRP and BMA tray	ABS-2016-02

Fresh Osteochondral Allografts (OCAs)

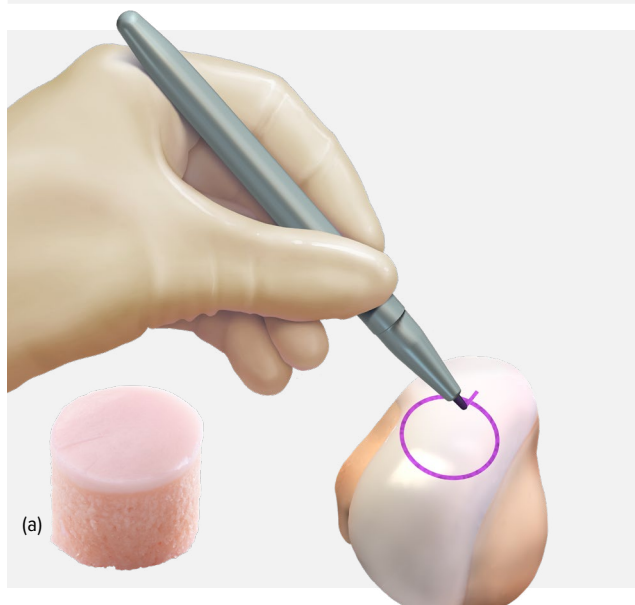

As the market leader in cartilage preservation, Arthrex offers the most comprehensive articular cartilage product portfolio, including several solutions for osteochondral allograft (OCA) transplantation. Fresh OCAs are comprised of mature hyaline cartilage containing viable chondrocytes and subchondral bone intended for OCA transfer procedures.

A key benefit of fresh osteochondral allograft transplantation is that viable chondrocytes are efficiently stored and provide the structural and functional units to replace diseased articular tissue.

Chondrocyte viability in OCA is critical to graft survival and clinical outcomes.¹

Arthrex partners with both JRF Ortho and LifeNet Health to source fresh cartilage allografts. Both JRF Ortho and LifeNet health offer patient-specific matching for fresh osteochondral allografts. Though matching is not required, it is encouraged to ensure an appropriate allograft is selected for the procedure. An acceptable geometric match is linked to restoration of physiologic contact stresses at the joint, whereas elevated or incongruent grafts can lead to increased pressures.²

Bone marrow stimulation using the PowerPick™ device can be done prior to graft implantation to prepare the bone bed.

OCA Cores

Product Description	JRF Ortho (Part Number)	LifeNet Health (Part Number)
10 mm OCA core	45647010	RFP10
12 mm OCA core	45647012	
16 mm OCA core (a)	45647016	RFP16

Osteochondral Allografts

Product Description	JRF Ortho (Part Number)	LifeNet Health (Part Number)
Lateral hemi femoral condyle right/left	Right (32147001) Left (32147002)	Right (FCD80) Left (FCA80)
Medial hemi femoral condyle right/left	Right (32247001) Left (32247002)	Right (FCC80) Left (FCB80)
Talus right/left	Right (32647001) Left (32647002)	Right (ATR80) Left (ATL80)
Distal tibia right/left	Right (32747001) Left (32747002)	Right (TDR80) Left (TDL80)

Specialty Grafts

Product Description	JRF Ortho (Part Number)	LifeNet Health (Part Number)
Femoral head right/left	Right (41847001) Left (41847002)	Right (FHR80) Left (FHL80)
BiCompartment, lateral and trochlea right/left	Right (43747003) Left (43747004)	Right (FTD80) Left (FTA80)
BiCompartment, medial and trochlea right/left	Right (43647003) Left (43647004)	Right (FTC80) Left (FTB80)
Femoral trochlea right/left	Right (43547001) Left (43547002)	Right (FTR80) Left (FTL80)
Whole distal femur right/left	Right (33547001) Left (33547002)	Right (FCR80) Left (FCL80)
Whole tibial plateau w/ meniscus right/left	Right (32447001) Left (32447002)	Right (TFR80) Left (TFL80)
Lateral tibial plateau w/ meniscus right/left	Right (45047001) Left (45047002)	
Medial tibial plateau w/ meniscus right/left	Right (44947001) Left (44947002)	
Patella right/left	Right (33647001) Left (33647002)	Right (PAR80) Left (PAL80)
Humeral head right/left	Right (41247001) Left (41247002)	Right (HHR80) Left (HHL80)
Distal humerus right/left	Right (44647001) Left (44647002)	
Proximal ulna right/left	Right (45847001) Left (45847002)	
Proximal metatarsal right/left	Right (44747001) Left (44747002)	
Distal metatarsal right/left	Right (44847001) Left (44847002)	

References

1. Cook JL, Stannard JP, Stoker AM, et al. Importance of donor chondrocyte viability for osteochondral allografts. *Am J Sports Med.* 2016;44(5):1260-1268. doi:10.1177/0363546516629434
2. Koh JL, Wirsing K, Lautenschlager E, Zhang LO. The effect of graft height mismatch on contact pressure following osteochondral grafting: a biomechanical study. *Am J Sports Med.* 2004;32(2):317-320. doi:10.1177/0363546503261730

Allograft OATS® System

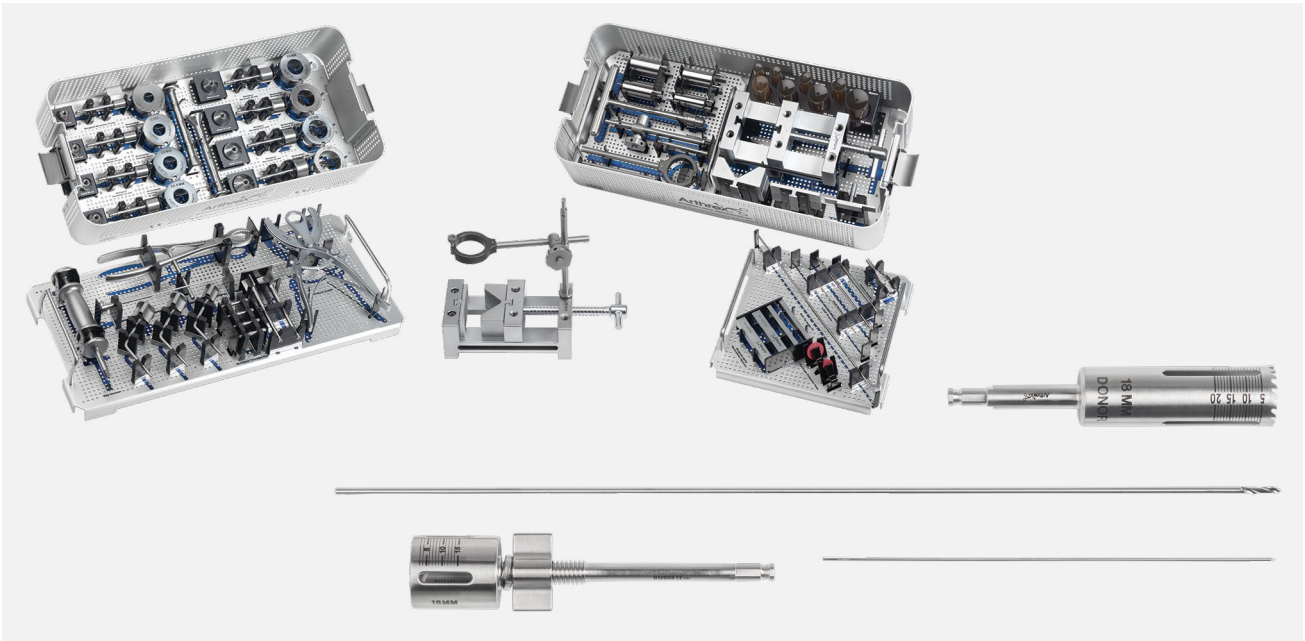

The allograft OATS system can be used for intraoperative harvesting of 15 mm to 35 mm diameter cores from fresh allografts. This system is a treatment option for patients with large symptomatic cartilage lesions with subchondral bone damage.

Using allografts for osteoarticular resurfacing gives surgeons the ability to match the contour and cartilage morphology of the recipient site while avoiding multiple surgical sites and the possible donor-site morbidity associated with recovering an autograft from the knee.

Fresh grafts are stored in a proprietary storage media and maintained at 4° C. These grafts should be implanted as soon as possible to maintain the highest levels of viable chondrocytes.

Product Description	Item Number
Allograft OATS instrument set	AR-41006
Allograft OATS disposable kit, Sizes: 15 mm, 18 mm, 20 mm, 22.5 mm, 25 mm, 27.5 mm, 30 mm, 35 mm	ABS-4057D-15 – 35

BioUni® OATS® System

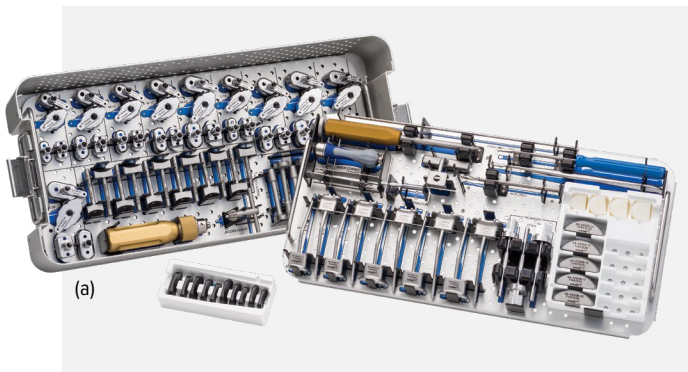

(a)

The BioUni instrument set is the new standard for restoration of the articular surface when presented with elongated cartilage defects in the femoral condyle. Through a series of precisely designed cutting instruments, surgeons can replace damaged cartilage with a single elliptical piece of viable hyaline cartilage. BioUni instruments address many of the challenges and risks associated with the recovery and implantation of multiple small and large cartilage cores. Overlapping multiple cores adds complexity of curve matching, fit, and surgical time for each procedure.

(b)



BioUni instruments were designed to match the natural curvature of the femoral condyle to remove those complexities. Multiple sizes allow flexibility for the surgeon to adjust the width and length of the cartilage defect and to ensure proper restoration of the articular surface with a single cartilage piece.

Product Description	Item Number
BioUni OCA instrument set (a)	AR-4058MS
BioUni disposable kit (b)	ABS-4080D
BioUni cutting kits Sizes: S14, S17, M14, M17, M20, L14, L17, L20, X17, X20	ABS-4080D-S14 – X20



Opening Wedge Osteotomy

Opening Wedge Osteotomy Implants.....	120
iBalance® HTO Instrumentation	121
Tibial and Femoral Osteotomy Systems.....	121
Optional Instrumentation	122
Bone Void Filler Options.....	123

Opening Wedge Osteotomy Implants

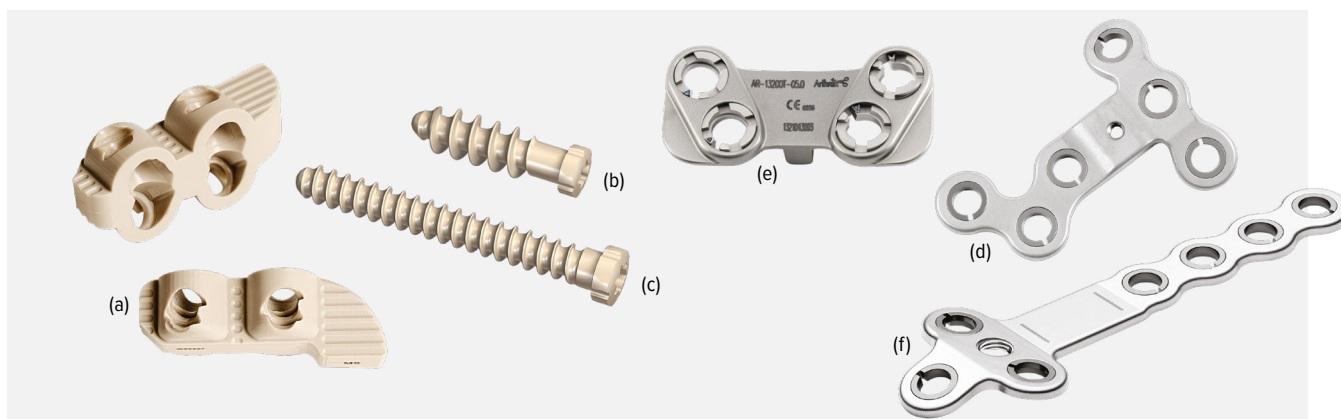

The iBalance® HTO implant consists of nonabsorbable polyetheretherketone (PEEK) implants and anchors that are inserted into the proximal tibial opening wedge osteotomy site during HTO procedures to maintain and fixate the osteotomy. This is an alternative option to traditional metal plates and screws. The iBalance HTO implants and anchors are intended for permanent implantation and, in some cases, negate the need for a second surgical procedure to remove hardware due to overlying soft-tissue irritation. To promote healing and provide added rigidity to the repair, the suggested bone void fillers are injectable, resorbable QuickSet™* cement, OSferion, BoneSync™ cement, AlloSync™ Pure demineralized bone matrix, and AlloSync putty (ABS-3016).

The ContourLock™ tibial and femoral opening wedge osteotomy plates and screws are designed to be anatomically curved and low profile, which still allows screws to be locked into the plate, creating a rigid construct in conjunction with 6.5 mm cancellous and 4.5 mm cortical screws. The wedgeless plates are available for opening and closing wedge osteotomies. Both plating systems allow the surgeon to angle each screw for optimum screw placement within the bone.

*QuickSet is a registered trademark of Graftys, S.A.

iBalance Implants

Product Description	Item Number
iBalance HTO implant, SM 12° (a)	AR-13400S-12
iBalance HTO implants, SM 6°/MD 5° – SM 15°/MD 13°	AR-13400M-05 – 13
iBalance HTO implants, MD 14° and 15°	AR-13400M-14 and 15
iBalance HTO implant, LG 5°	AR-13400L-05
iBalance HTO implants, LG 6°/XL 5° – LG 15°/XL 14°	AR-13400L-06 – 15

iBalance Anchors

Product Description	Item Number
iBalance HTO anchors, 20-32 mm, cancellous (b)	AR-13401-20-32
iBalance HTO anchors, 24-52 mm, cortical (c)	AR-13402-24-52

iBalance HTO Plates

Product Description	Item Number
ContourLock HTO plates, flat, left, 67 mm, 71 mm, 84 mm (d)	AR-13730-01, 02, 03
ContourLock HTO plates, flat, right, 67 mm, 71 mm, 84 mm	AR-13735-01, 02, 03
Osteotomy plate tibial opening wedge, 5-17.5 mm (e)	AR-13200ST-05-17.5
Osteotomy plate opening wedge, 5-17.5 mm	AR-13200T-05-17.5
Osteotomy plate tibial opening wedge, 3-17.5 mm	AR-13200-03-17.5
Osteotomy plate distal tibial opening wedge, 5-10 mm	AR-13200D-05-10
Osteotomy plate tibial sloped A/P opening wedge, 5-17.5 mm	AR-13200PA-05-17.5

iBalance DFO Plates

Product Description	Item Number
ContourLock femoral osteotomy plate, right, S/M (f)	AR-13110R-01
ContourLock femoral osteotomy plate, right, L/XL	AR-13110R-02
ContourLock femoral osteotomy plate, left, S/M	AR-13110L-01
ContourLock femoral osteotomy plate, left, L/XL	AR-13110L-02

Titanium Osteotomy Screws

Product Description	Item Number
HTO plate screws, 6.5 mm × 35-70 mm, cancellous (5 mm increments)	AR-13280-35 – 70
HTO plate screws, 4.5 mm × 26-60 mm (2 mm increments)	AR-13380-26 – 60

iBalance® HTO Instrumentation

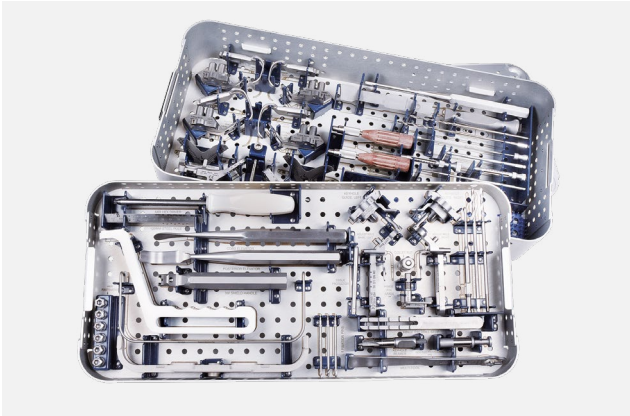

The iBalance HTO system, which is specific to iBalance HTO implants, creates an “envelope” using retractors, allowing surgeons to create cuts in a highly reproducible manner. This instrument set may reduce the chance of neurovascular injury and lateral hinge fractures. The instruments also allow for alignment of the osteotomy to the sagittal and coronal planes to preserve tibial slope. A step-by-step guided technique of the iBalance HTO system builds surgeon confidence through reproducibility.

Product Description	Item Number
iBalance HTO Instrument Set	AR-13400S

Literature (Instrument Reference Guides)

Product Description	Item Number
iBalance HTO instrumentation assembly guide	LB0122
iBalance HTO system layout and assembly guide	BR1-001459
iBalance opening wedge osteotomy surgical technique	LT1-0122-EN

See page 116 for optional instrumentation.

Tibial and Femoral Osteotomy Systems

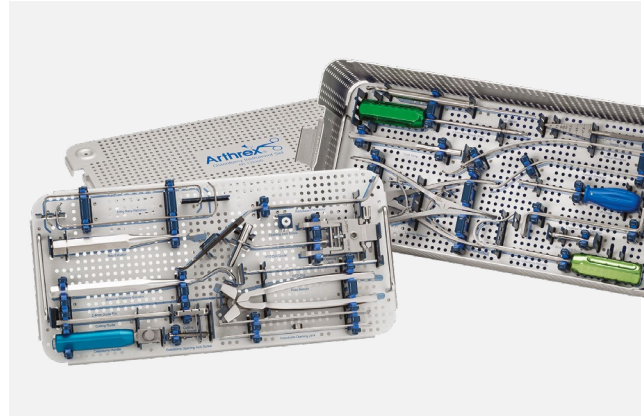

The opening wedge osteotomy system was developed for the treatment of pain and/or instability associated with lower extremity malalignment. The use of unique plates, in conjunction with an opening wedge osteotomy, provides surgeons with a reliable and reproducible technique for tibial and femoral osteotomies. The technique preserves normal anatomy of the lateral side of the knee while minimizing morbidity associated with closing wedge osteotomies. Opening wedge osteotomies can be performed concomitantly with ACL reconstruction and osteochondral and meniscal transplants.

Product Description	Item Number
Opening wedge osteotomy set, tibial	AR-13330TS
Opening wedge osteotomy set, femoral	AR-13330S

Optional Instrumentation

Optional Instrumentation

Product Description	Item Number
Ratcheting handle w/ AO connection	AR-8950RH
Anchor drill AO connection	AR-13434-02
iBalance® graft tamp, rectangular end	AR-13432
Cobb elevator	AR-13411-01
Osteotome jack, 35 mm	AR-13323-35

All Sets Include Flexible Osteotome Handle (Blades Sold Separately)

Product Description	Item Number
Flexible osteotome blade, 10 mm, 25 mm, and 35 mm	AR-13302F-10 – 35

Optional Handle and Reusable Blade

Product Description	Item Number
Osteotome handle	AR-13301
Osteotome blade, 10 mm, 25 mm, and 35 mm	AR-13302-10 – 35

Additional Osteotomy Instruments Not Available in a Set

Product Description	Item Number
Osteotomy wedge	AR-13300
Osteotomy guide pin, 3.0 mm	AR-13303-3.0
Guide sleeve body parallel	AR-13304-1
Guide sleeve parallel	AR-13304-2
Osteotomy guide assembly	AR-13305
Osteotomy cutting guide	AR-13306-01
Osteotomy pin	AR-13306-02
Alignment rod	AR-13308
Application bar for HTO plates	AR-13318
Universal bending iron, osteotomy plates	AR-13322-02
Osteotome jack gauge	AR-13323G
A/P sloped osteotomy wedge trial, LG	AR-13325L
A/P sloped osteotomy wedge trial, SM	AR-13325S
Screwdriver, 90°, 3.5 mm hex	AR-13326-90

Bone Void Filler Options

Arthrex offers a comprehensive portfolio of bone repair solutions ranging from autografts, allografts and synthetic bone void fillers. These biologic products can be used to help support bone repair and remodeling in osteotomy procedures.

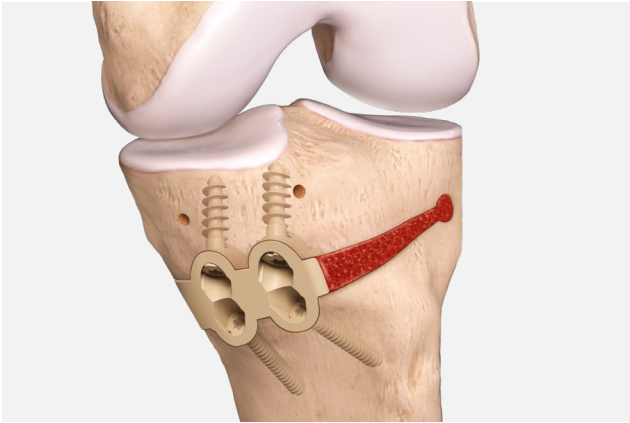

Suggested Bone Substitute

Product description	Item number
OSferion Osteotomy Wedge (a)	
OSferion osteotomy wedge, 7 mm × 30 mm	AR-13370-1
OSferion osteotomy wedge, 10 mm × 30 mm	AR-13370-2
OSferion osteotomy wedge, 12 mm × 35 mm	AR-13370-3
OSferion osteotomy wedge, 15 mm × 35 mm	AR-13370-4
OSferion Trapezoid (a)	
OSferion trapezoid, 8 mm × 25 mm × 7 mm × 75 mm	AR-13372-1
OSferion trapezoid, 9 mm × 25 mm × 7 mm × 75 mm	AR-13372-2
OSferion trapezoid, 10 mm × 25 mm × 7 mm × 75 mm	AR-13372-3
AlloSync™ Pure DBM (c)	
AlloSync Pure DBM, 1 cc	ABS-2010-01
AlloSync Pure DBM, 2.5 cc	ABS-2010-02
AlloSync Pure DBM, 5 cc	ABS-2010-05
AlloSync Pure DBM, 10 cc	ABS-2010-10
AlloSync Expand	
AlloSync Expand demineralized cortical fibers, 1 cc	ABS-2017-01
AlloSync Expand demineralized cortical fibers, 2.5 Cc	ABS-2017-02
AlloSync Expand demineralized cortical fibers, 5 cc	ABS-2017-05
AlloSync Expand demineralized cortical fibers, 10 cc	ABS-2017-10
BoneSync™ Cement (d)	
BoneSync cement, 3 cc	AR-3103
BoneSync cement, 5 cc	AR-3105
BoneSync cement, 10 cc (2 × 5 cc kit)	AR-3105-2
BoneSync Putty (d)	
Putty, 2.5 cc	ABS-3202
Putty, 5 cc	ABS-3205
Putty, 10 cc	ABS-3210
Putty, 15 cc	ABS-3215
BoneSync Strips	
Strip, 10 cc	ABS-3310
Strip, 15 cc	ABS-3315
Quickset™ Kits (b)	
Kit, 5 cc	ABS-3005
Kit, 8 cc	ABS-3008
Kit, 16 cc	ABS-3016

Bone Graft Harvesting

Bone Graft Harvester	126
GraftNet™ Autologous Tissue Collector.....	126
OsteoAuger™ Bone Graft Harvesting System	127

Bone Graft Harvester



The single-use Bone Graft Harvester Set includes a minimally invasive 6 mm-, 8 mm-, or 10 mm-diameter bone graft harvester, an impaction bar, and a twist knob. It is ideal for harvesting autograft bone dowels from the anterior-superior and posterior-superior iliac crest. The Bone Graft Harvester Set is an excellent option for bone grafting procedures and can be used through small incisions with minimal damage to cortical bone.

Product Description	Item Number
Bone graft harvester, 6 mm, 8 mm, and 10 mm	AR-1981-06H – 10H

GraftNet™ Autologous Tissue Collector



The suction-activated GraftNet device is designed to collect autologous tissue for a multitude of applications, such as the BioACL™ technique. The GraftNet XL device was created to allow for a large volume of autologous bone to be collected and integrated into the reconstruction. Both devices allow for case-by-case flexibility with universal inflow and outflow adapters and make accessing autologous bone as simple as Resect and Collect™.

GraftNet device use with the BioACL technique

- When preparing an ACL tunnel for BTB reconstruction, the GraftNet (a) or GraftNet XL (b) device can be used to recover bone that can be used to backfill the harvest site.
- Once recovered, mix the autograft bone with AlloSync™ Pure and cPRP from BMA processed with the Angel® system to re-deliver into the ACL tunnels.

Product Description	Item Number
Angle cPRP and BMA tray	ABS-10062T
GraftNet autologous tissue collector	ABS-1050
AlloSync Pure demineralized bone matrix, 5 cc	ABS-2010-05
BioXpress™ graft delivery device, angled tip cannula	ABS-1053-15-45

OsteoAuger™ Bone Graft Harvesting System

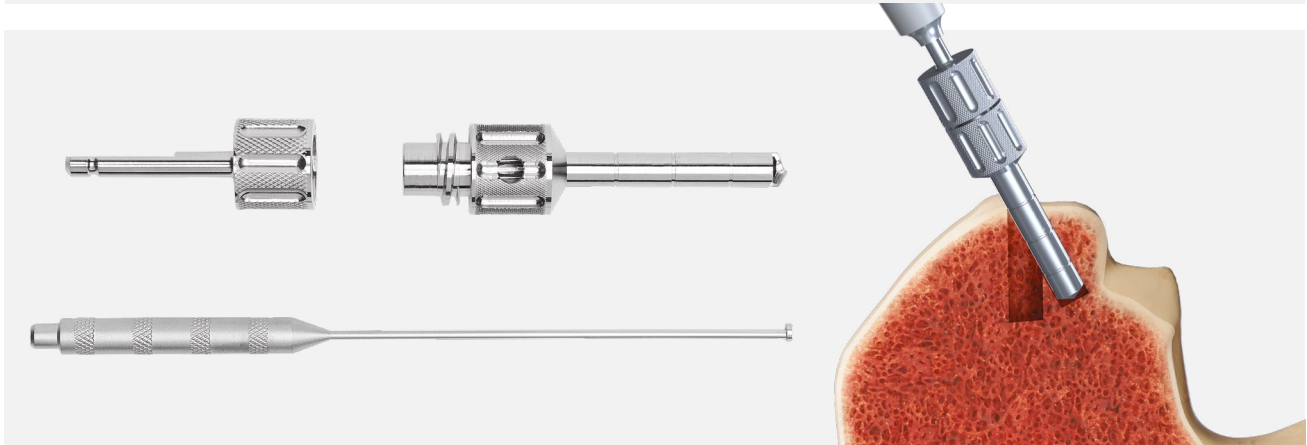

The OsteoAuger bone graft harvesting system allows for quick and efficient recovery of autologous bone from various anatomic sites. The sharp cutting tip of the system morselizes and collects the bone graft for reimplantation at the repair site.

Fully Sterile System

- Pilot hole creation not required
- AO quick-connect adaptor
- Morselizing cutting tip
- Plunger provided for simplified graft removal

Harvest Sites

- Distal tibia (6 mm, 8 mm, and 10 mm)
- Proximal tibia (8 mm and 10 mm)
- Iliac crest (6 mm and 8 mm)

Product Description	Item Number
OsteoAuger bone graft harvesting system, 6 mm	ABS-8000-06
OsteoAuger bone graft harvesting system, 8 mm	ABS-8000-08
OsteoAuger bone graft harvesting system, 10 mm	ABS-8000-10



This description of technique is provided as an educational tool and clinical aid to assist properly licensed medical professionals in the usage of specific Arthrex products. As part of this professional usage, the medical professional must use their professional judgment in making any final determinations in product usage and technique. In doing so, the medical professional should rely on their own training and experience and should conduct a thorough review of pertinent medical literature and the product's directions for use. Postoperative management is patient-specific and dependent on the treating professional's assessment. Individual results will vary and not all patients will experience the same postoperative activity level and/or outcomes.

arthrex.com

© 2024-11 Arthrex, Inc. All rights reserved. LB1-0115-en-US_AC



Arthrex manufacturer,
authorized representative,
and importer information
(Arthrex eIFUs)



US patent information